

POLY 1X4 LED

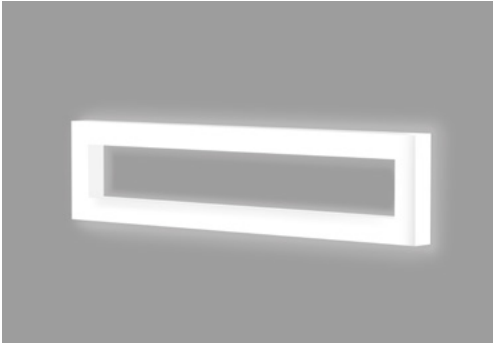

WALL



DESCRIPTION

Poly's geometric forms, appropriately scaled for use as discrete luminaires, offer new opportunities for creative approaches to general lighting. Poly rectangular wall can distinguish a variety of special areas. The open form is airy and features a compact 2.5" profile (drivers are remote). Poly neatly complements recessed modular luminaires. Efficacies up to 121 LPW, multiple lumen outputs and electrical options make Poly practical, as well as creative.

PROJECT: _____

TYPE: _____

NOTES: _____

ORDER GUIDE

POLW	14	ULO	LED				
LUMINAIRE ID	SIZE	OPTICS	LIGHT SOURCE	CRI	LUMEN PACKAGES	COLOR TEMP.	VOLTAGE
POLW - poly wall	14 - 1'X4'	ULO - Uniform Lambertian Optic	LED - high performance LED	80 - 80CRI 90 - 90CRI	2400 - min. low output 2400lm 4000 - medium output 4000lm #### - other required lm	27 - 2700k 30 - 3000k 35 - 3500k 40 - 4000k	120 - 120V 277 - 277V UNV - 120V-277V 347 - 347V (not available with Lutron)
DRIVER	RDB	1	DMB				
DRIVER	REMOTE DRIVER BOX	ELECTRICAL	MOUNTING	FINISH	OPTIONS		
D1 - 1% dimming 0-10V DA - Dali LTEA2W - Lutron 1% - 2 wire FF 120V LDE1 - Lutron Hi-lume 1% Eco LDE5 - Lutron 5% EcoSystem	RDB - Remote driver box	1 - 1 circuit	DMB - drywall mounting bracket	W - matte white CF# - custom finish specify RAL#	FU - fuse CU - custom		

See page 3 for ordering code detailed information

SECTION VIEW

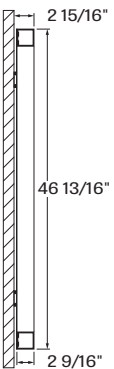

POLW-14 - wall

TOP VIEW

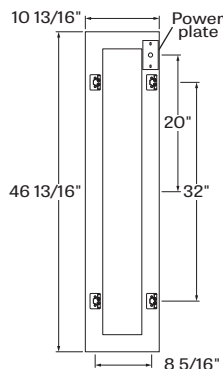

POLW-14 - wall

POLY 1X4 LED

WALL

ELECTRICAL CIRCUITS

DIMMING 0-10V -

1 Circuit

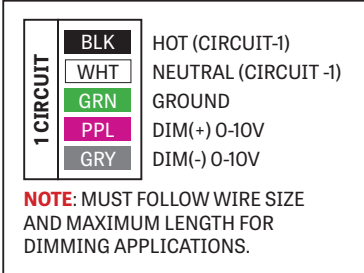

LUTRON 1% 2-wire FF 120V -

1 Circuit

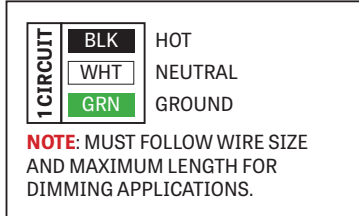

LUTRON LDE1 1%/LDE5 5% EcoSystem -

1 Circuit

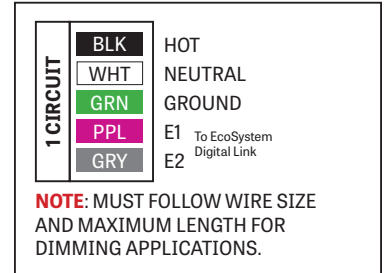

POLY 1X4 LED

WALL

OPTICS

The **Uniform Luminous Optic (ULO)** drop lens of thermoformed acrylic provides three luminous faces with subtle uplight.

LIGHT SOURCE - LED

Custom array of mid-flux LED's are mounted directly to the housing for optimal thermal performance. Available in 3000K, 3500K, 4000K and 5000k with a minimum 80 CRI and an option for 90 CRI with elevated R9 value. Color consistency maintained to within 3 SDCM. LEDs operated at reduced drive current to optimize efficacy and lumen maintenance.

All LEDs have been tested in accordance with IESNA LM-80-08 and the results have shown L80 lumen maintenance greater than 60,000 hours. Absolute product photometry is measured and presented in accordance with IESNA LM-79, unless otherwise indicated.

ELECTRICAL REMOTE

Driver features factory-set adjustable output current with universal (120-277VAC) input. Dimmable from 100% to 1% with 0-10V dimming control. Rated life (90% survivorship) of 50,000 hours at 50°C max. ambient (and 70°C max. case) temperature. At maximum driver load: Efficiency > 84%, PF > 0.9, THD < 20%. Other specifiable options include Lutron Hi-Lume 1% (specify 2-wire or Ecosystem Dim-to-Off), Lutron 5-Series (5% Ecosystem), DMX (RDM compatible) and DALI protocol drivers. All of our standard 0-10V drivers are NEMA 410 compliant.

REMOTE DRIVER

The factory-provided remote driver enclosure is accessible from below both drywall and grid ceilings.

MOUNTING OPTIONS

Fixtures may be mounted to the wall using a bracket.

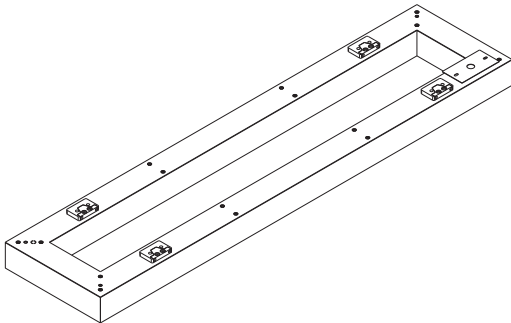

FINISH

95% reflective, matte white powder coating

CONSTRUCTION

Reflector plate (LED holder) - Die formed cold rolled sheet steel 18 gauge thick, 95% reflective matte white painted

Lens - white acrylic

Wall bracket - die cast aluminum, matte white powder coating

WEIGHT

POLY 1X4 - 8.74lbs - 3.96kg

CERTIFICATIONS

ETL - Rated for Indoor Dry/Damp locations.

Conforms to UL Standard 1598 and certified to CAN/CSA Standard C22.2 No. 250.0.

WARRANTY

LumenWerx provides a five-year limited warranty of electrical and mechanical performance of the luminaires, including the LED boards, drivers, and auxiliary electronics. LumenWerx will repair or replace defective luminaires or components at our discretion, provided they have been installed and operated in accordance with our specifications. Other limitations apply, please refer to the full warranty on our website.