

POP COLOR SQUARE 1x1

LUMENWERX

SURFACE
STATIC WHITE



Project: _____

Type: _____

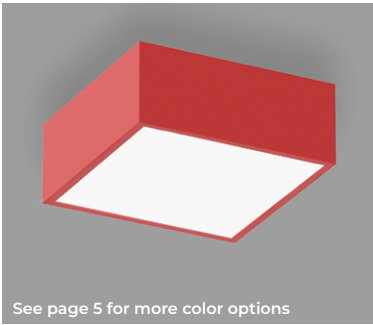

See page 5 for more color options

DESCRIPTION

POP Color features a painted housing with a uniformly luminous diffuser that sits flush, regressed or drops up to 2" below. The diffuser and light engine form a fully enclosed unit secured by a twist-and-lock mechanism for easy maintenance with no exposed hardware. POP Color delivers up to 103 LPW and is available in nine standard housing colors.

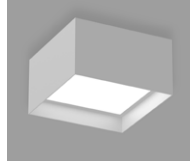

Flush lens

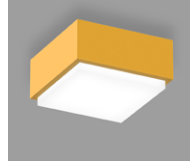

2" regressed lens

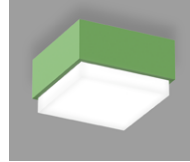

1" drop lens

2" drop lens

Order Guide

Up to 103 lm/W performance

LUMINAIRE ID	SIZE	OPTIC	LENS POSITION	LIGHT SOURCE ¹	CRI	LUMEN PACKAGE
PCSQS	1FTX1FT	ULO		SW		
PCSQS - Pop Color Square Surface	1FTX1FT - 1' X 1'	ULO - Uniform Lambertian Optic	FH - Flush 2R - 2" regressed 1D - 1" drop 2D - 2" drop	SW - Static white ¹ Chromawerx Sola and Duo also available. Consult other spec sheet.	80 - 80 CRI 90 - 90 CRI	750 - Min. low output 750lm 900 - Medium output 900lm 1100 - Max. high output 1100lm #### - Other required lm

COLOR TEMP.	VOLTAGE	DRIVER ³	ELECTRICAL	MOUNTING
			1	SUR
27 - 2700K 30 - 3000K 35 - 3500K 40 - 4000K	120 - 120V 277 - 277V UNV - 120V-277V 347 ² - 347V ² Available with DI only.	DI - 1% 0-10V DA ⁴ - DALI LDE1 ⁴ - Lutron Hi-lume 1% Eco ELD1 - eldoLED 1% ECOdrive 0-10V ELD0 - eldoLED 0.1% SOLOdrive 0-10V ³ PoE (Power-over-Ethernet) compatible. Consult factory for details. ⁴ On-site commissioning is required.	1 - 1 circuit	SUR - Surface mount

FINISH	OPTIONS
W - Matte white AL - Aluminum BK - Black RAL 1028 - Yellow RAL 2004 - Orange RAL 3020 - Red RAL 4010 - Magenta RAL 5002 - Blue RAL 6018 - Green CF# - Custom finish specify RAL#	FU120 - Fuse 120V FU277 - Fuse 277V NA - None

POP COLOR SQUARE 1x1

LUMENWERX

SURFACE
STATIC WHITE

Dimensions

POP COLOR FH - FLUSH

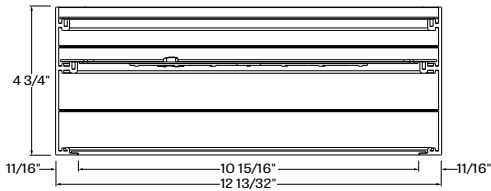
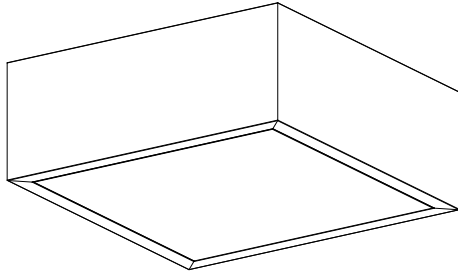

POP COLOR 2R - 2" REGRESSED

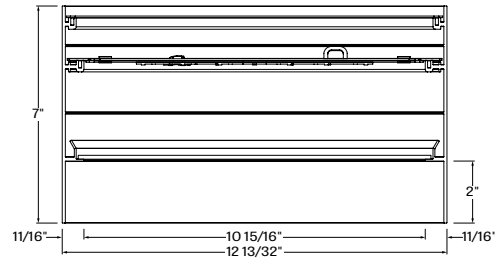
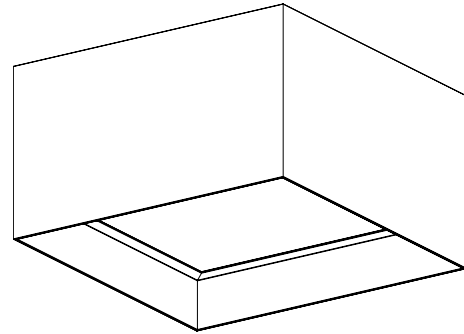

POP COLOR 1D - 1" DROP

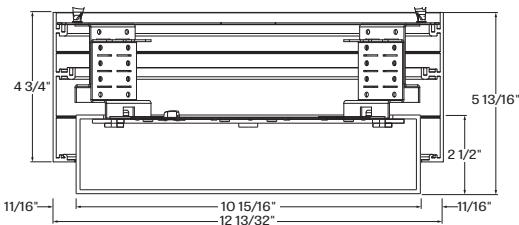
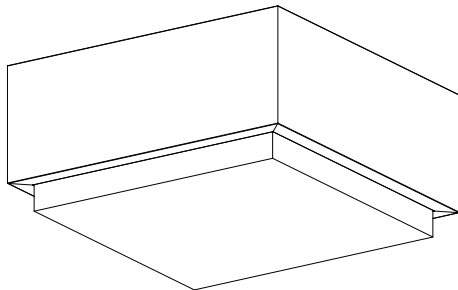

POP COLOR 2D - 2" DROP

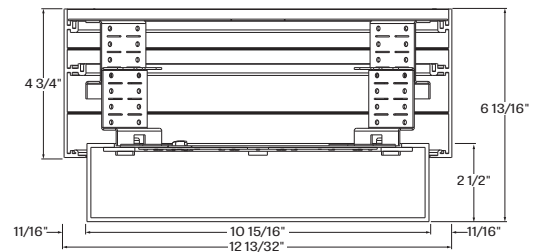
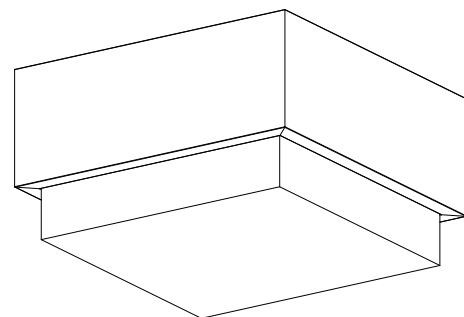

POP COLOR SQUARE 1x1

LUMENWERX

SURFACE
STATIC WHITE

Photometrics

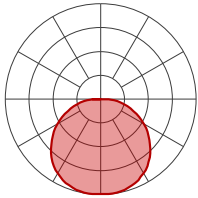

750 LUMEN AT 80 CRI - LOW OUTPUT

LED OUTPUT	COLOR TEMP	WATTS	NOMINAL DELIVERED LUMENS	EFFICACY LPW
Low output	2700K	8	750	95
Low output	3000K	8	750	97
Low output	3500K	7.5	750	100
Low output	4000K	7.5	750	103

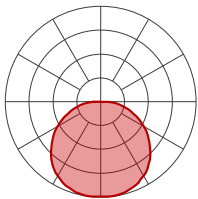

900 LUMEN AT 80 CRI - MEDIUM OUTPUT

LED OUTPUT	COLOR TEMP	WATTS	NOMINAL DELIVERED LUMENS	EFFICACY LPW
Medium output	2700K	9.5	900	95
Medium output	3000K	9.5	900	97
Medium output	3500K	9	900	100
Medium output	4000K	8.5	900	103

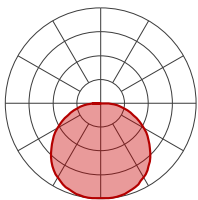

1100 LUMEN AT 80 CRI - HIGH OUTPUT

LED OUTPUT	COLOR TEMP	WATTS	NOMINAL DELIVERED LUMENS	EFFICACY LPW
High output	2700K	11.5	1100	95
High output	3000K	11.5	1100	97
High output	3500K	11	1100	100
High output	4000K	10.5	1100	103

SURFACE
STATIC WHITE

Technical Specifications

OPTIC

Uniform Efficiency Lambertian Optic (ULO)

Made of formed impact modified white PMMA, the optic provides an even light distribution with up to 88% transmission. Its unique enclosed shell design protects LEDs against Electrostatic Discharge and dust while its back surface project a soft glow on the mounting surface.

LENS POSITION

Pop Color square 11 surface is available in 4 lens configurations.

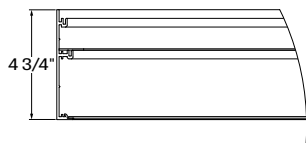

PCSQS + FH - Flush lens

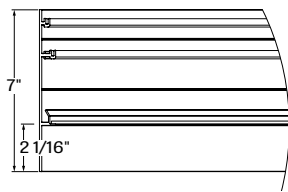

PCSQS + 2R - 2" regressed lens

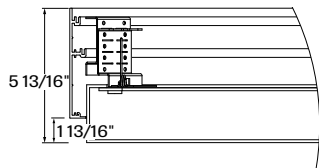

PCSQS + 1D - 1" drop lens

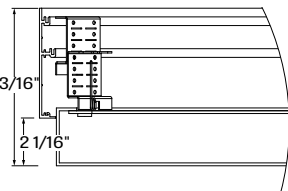

PCSQS + 2D - 2" drop lens

LIGHT SOURCE

Custom array of mid-flux LEDs are mounted directly to the housing for optimal thermal performance. Available in 2700K, 3000K, 3500K and 4000K with a minimum 80 CRI and an option for 90 CRI with elevated R9 value. Color consistency maintained to within 3 SDCM. LEDs operated at reduced drive current to optimize efficacy and lumen maintenance.

All LEDs have been tested in accordance with IESNA LM-80-08 and the results have shown L80 lumen maintenance greater than 60,000 hours. Absolute product photometry is measured and presented in accordance with IESNA LM-79, unless otherwise indicated.

ELECTRICAL

Factory-set, adjustable output current LED driver with universal (120-277VAC) input. Dimmable from 100% to 1% with 0-10V dimming control. Rated life (90% survivorship) of 50,000 hours at 50°C max. ambient (and 70°C max. case) temperature. At maximum driver load: Efficiency > 84%, PF > 0.9, THD < 20%. Other specifiable options include Lutron Hi-Lume 1% (specify 2-wire, or Ecosystem Dim-to-Off), eldoLED 1% ECOdrive 0-10V, eldoLED 0.1% SOLOdrive 0-10V, and DALI protocol drivers. All of our standard 0-10V drivers are NEMA 410 compliant.

PoE

Depending on the PoE manufacturer selected, Lumenwerx will install the node in factory as either integral to the luminaire or as a remote module. Factory programming of the PoE node may or may not enable the following functionalities: lumen package, Duo (tunable white) emergency battery backup, and sensor integration. These must be addressed and evaluated on a case-by-case basis.

MOUNTING OPTION

Fixtures can be mounted directly to T-bar, drywall and hard surface ceilings. Mounting hardware supplied by others.

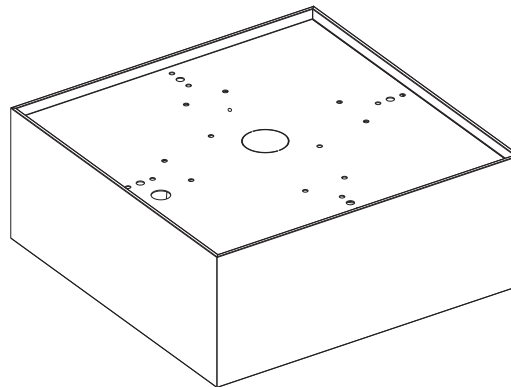

SUR - Surface mount

POP COLOR SQUARE 1x1

LUMENWERX

SURFACE
STATIC WHITE

FINISH

Interior - 95%, reflective, matte white powder coating

Exterior - Side trim is offered in a range of vibrant color powder coating.

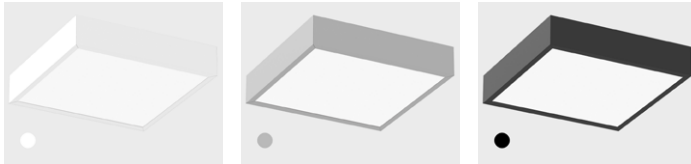

W - Matte white

AL - Aluminum

BK - Black

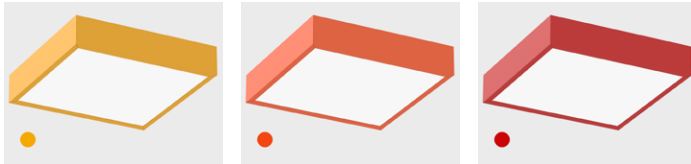

RAL 1028 - Yellow

RAL 2004 - Orange

RAL 3020 - Red

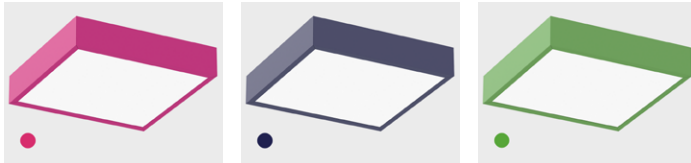

RAL 4010 - Magenta

RAL 5002 - Blue

RAL 6018 - Green

CONSTRUCTION

Housing - Welded aluminum extrusion .125in thick, wide variety of colored powder coating

Diffuser - Uniform Lambertian Optic, thermoformed impact modified acrylic, completely enclosed

WEIGHT

RD 11 Flush, 2R, 1D, 2D - 8.79lb - 4kg

CERTIFICATION

ETL - Rated for Indoor Dry/Damp locations. Conforms to UL Standard 1598 and certified to CAN/CSA Standard C22.2 No. 250.0.

WARRANTY

Lumenwerx provides a five-year limited warranty of electrical and mechanical performance of the luminaires, including the LED boards, drivers, and auxiliary electronics. Lumenwerx will repair or replace defective luminaires or components at our discretion, provided they have been installed and operated in accordance with our specifications. Other limitations apply, please refer to the full warranty on our website.