

POP CORE ROUND 12 LED



LUMENWERX
WWW.LUMENWERX.COM

SURFACE-WALL



Surface with 3.5" optic



Wall with 3.5" optic

PROJECT: _____

TYPE: _____

NOTES: _____

DESCRIPTION

POP Core features a simple, uniformly luminous diffuser and delivers up to 103 LPW. The diffuser and light engine form a fully enclosed unit secured by a twist-and-lock mechanism for easy maintenance with no exposed hardware.

ORDER GUIDE

up to 103 lm/W performance

POROS	12IN	ULO	3H	LED			
LUMINAIRE ID	SIZE	OPTIC	HEIGHT	LIGHT SOURCE	CRI	LUMEN PACKAGE	
POROS - Pop Round Surface-Wall	12IN - Ø 12"	ULO - Uniform Lambertian Optic	3H - 3.5" optic	LED - High performance LED	80 - 80CRI 90 - 90CRI	750 - Min. low output 750lm 900 - Medium output 900lm 1100 - Max. high output 1100lm #### - Other required lm	
COLOR TEMP.	VOLTAGE	DRIVER	ELECTRICAL	SUR	MOUNTING	FINISH	OPTION
27 - 2700K 30 - 3000K 35 - 3500K 40 - 4000K	120 - 120V 277 - 277V UNV - 120V-277V	D1 - 1% 0-10V DA - DALI LDE1 - Lutron Hi-lume 1% Eco	1 - 1 circuit +GTD - Generator transfer device	SUR	SUR - Surface mount	W - Matte white CF# - Custom finish specify RAL#	FU - Fuse

See page 3 for ordering code detailed information

CROSS SECTION

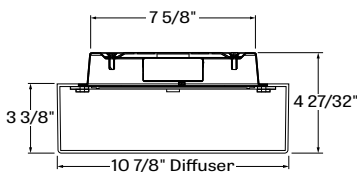

POROS + 3H - Pop Round Surface-Wall with 3.5" optic

POP CORE ROUND 12 LED

SURFACE-WALL

POP ROUND 3H - 3.5" OPTIC

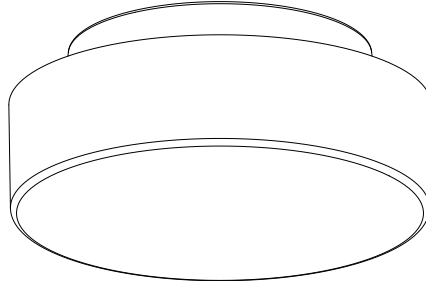

POROS + 3H - Pop Round Surface-Wall with 3.5" optic

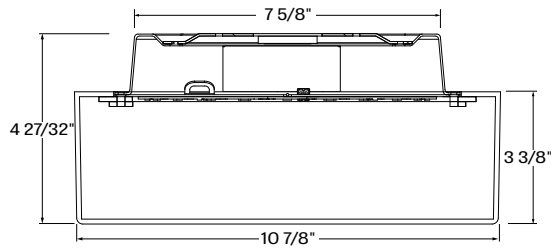

POP CORE ROUND 12 LED

SURFACE-WALL

OPTIC

Uniform Efficiency Lambertian Optic (ULO) - Made of formed impact modified white PMMA, the optic provides an even light distribution with up to 88% transmission. Its unique enclosed shell design protects LEDs against Electrostatic Discharge and dust while its back surface project a soft glow on the mounting surface.

OPTIC HEIGHT

Pop Round Surface-Wall 12 is available with 3.5" diffuser.

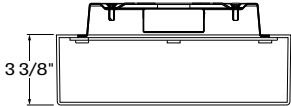

POROS + 3H - Pop Round Surface-Wall with 3.5" optic

LIGHT SOURCE

Custom array of mid-flux LEDs are mounted directly to the housing for optimal thermal performance. Available in 2700K, 3000K, 3500K and 4000K with a minimum 80 CRI and an option for 90 CRI with elevated R9 value. Color consistency maintained to within 3 SDCM. LEDs operated at reduced drive current to optimize efficacy and lumen maintenance.

All LEDs have been tested in accordance with IESNA LM-80-08 and the results have shown L80 lumen maintenance greater than 60,000 hours. Absolute product photometry is measured and presented in accordance with IESNA LM-79, unless otherwise indicated.

PERFORMANCE AT 4000K

LED output	Color Temp	Watts	Nominal Delivered Lumens	Efficacy LPW
Low output	4000K	7.5	750	101
Medium output	4000K	9	900	102
High output	4000K	10.5	1100	103

ELECTRICAL

Factory-set, adjustable output current LED driver with universal (120-277VAC) input. Dimmable from 100% to 1% with 0-10V dimming control. Rated life (90% survivorship) of 50,000 hours at 50°C max. ambient (and 70°C max. case) temperature. At maximum driver load: Efficiency>84%, PF>0.9, THD<20%. Other specifiable options include DALI protocol drivers. All of our standard 0-10V drivers are NEMA 410 compliant.

MOUNTING OPTIONS

A Twist and lock mounting system for clean look with no visible fastener and easy maintenance.

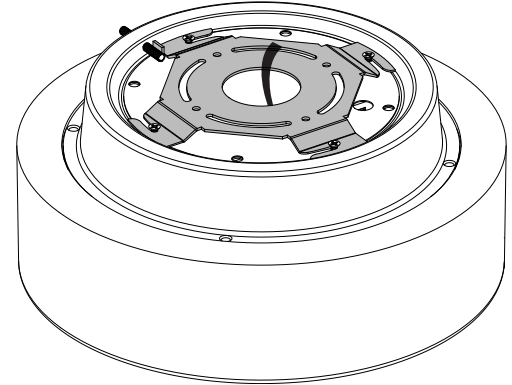

SUR - Surface mount

FINISH

Interior - 95% reflective, matte white powder coating

Exterior - Matte white powder coating.

CONSTRUCTION

Housing - 16 gauge spun aluminum, matte white powder coating

Diffuser - Uniform Lambertian Optic, thermoformed impact modified acrylic, completely enclosed

WEIGHT

RD 12 X 3.5 - 2.98lbs - 1.36kg

CERTIFICATIONS

ETL - Rated for Indoor Dry/Damp locations.

Conforms to UL Standard 1598 and certified to CAN/CSA Standard C22.2 No. 250.0.

WARRANTY

Lumenwerx provides a five-year limited warranty of electrical and mechanical performance of the luminaires, including the LED boards, drivers, and auxiliary electronics. Lumenwerx will repair or replace defective luminaires or components at our discretion, provided they have been installed and operated in accordance with our specifications. Other limitations apply, please refer to the full warranty on our website.

POP CORE ROUND 12 LED

SURFACE-WALL

750 LUMEN AT 80CRI - LOW OUTPUT

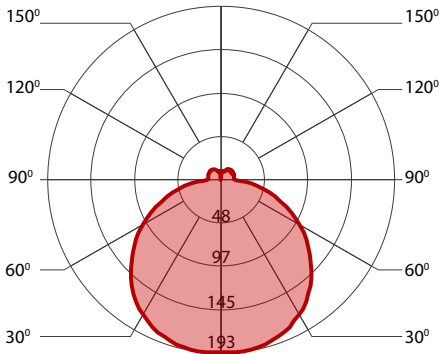

PERFORMANCE

LED output	Color Temp	Watts	Nominal Delivered Lumens	Efficacy LPW
Low output	2700K	8	750	93
Low output	3000K	8	750	95
Low output	3500K	7.5	750	98
Low output	4000K	7.5	750	101

900 LUMEN AT 80CRI - MEDIUM OUTPUT

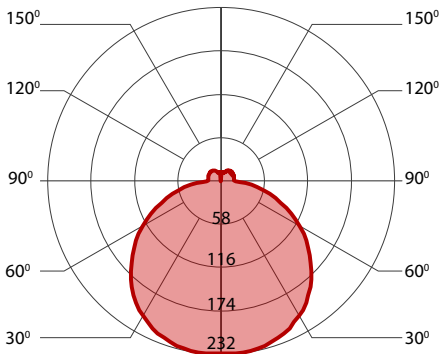

PERFORMANCE

LED output	Color Temp	Watts	Nominal Delivered Lumens	Efficacy LPW
Medium output	2700K	9.5	900	94
Medium output	3000K	9.5	900	96
Medium output	3500K	9	900	99
Medium output	4000K	9	900	102

1100 LUMEN AT 80CRI - HIGH OUTPUT

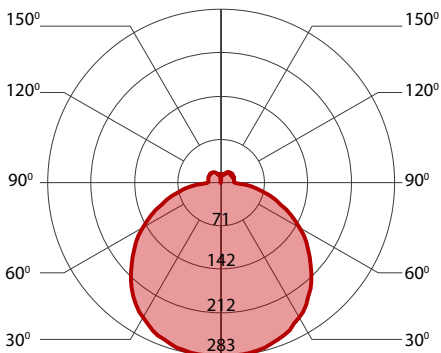

PERFORMANCE

LED output	Color Temp	Watts	Nominal Delivered Lumens	Efficacy LPW
High output	2700K	11.5	1100	95
High output	3000K	11.5	1100	97
High output	3500K	11	1100	100
High output	4000K	10.5	1100	103