

Voilà

True 2" Round Downlight
Wall Wash

LUMENWERX

Project: _____

Type: _____

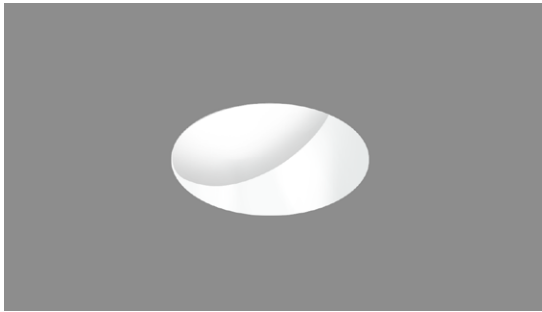

Trimless



Trim

Voilà 2" wall wash downlights feature innovative Hyflex™ optics for precise beam control. Shallow construction requires only 4" recess depth. Driver can be replaced through 2" aperture. The Voilà COB source with 90 CRI and 2-step color consistency matches other Lumenwerx luminaires, and is available in Chromawerx SOLA (dim-to-warm) and DUO (tunable white). Complete Voilà offering includes 2" and 4" apertures; downlights, adjustables, and wall washers; round and square trim; and cylinders; see separate specifications.

Performance

LUMEN OUTPUT ¹	WATTS	EFFICACY LM/W
775 lm	7 W	111 lm/W
953 lm	10 W	95 lm/W
1157 lm	14 W	83 lm/W

¹ Lumens packages are assuming 3500K, 80 CRI, round white baffle

Delivered Lumens

CRI	80 CRI (At 35K)	90 CRI (At 35K)	97 CRI (At 30K)
Low - 7 W	775	720	619
Medium - 9.8 W	953	886	762
High - 13.8 W	1157	1076	925



Aperture Size

2.00"

Configurations



Fixed, adjustable & wall wash (see other spec sheets for all the configurations)

Baffle Depth







Standard 0.52" Deep 1.06"

Trim





Trim & Trimless

Baffle & Trim Flange Finishes

Textured matte white 
 Textured matte black 
 Mixed black & white 
 Custom RAL 

Color Temperature

2700K 
 3000K 
 3500K 
 4000K 
 SOLA 
 DUO 

Delivered 775-1157 lm
7-14 Watts, up to 111 lm/W

Integral Drivers

0-10V, TRIAC & ELV

Remote Drivers

Lutron, eldoLED and other drivers
Remote emergency battery pack

1 - Housing (Example: VO2RRWW-TRM-SW-OF-ASB-120-7W-D1)

Product Specification

LUMINAIRE ID	TRIM STYLE	LIGHT SOURCE	INSTALLATION TYPE	MOUNTING OPTIONS	VOLTAGE	WATTAGE (80 CRI) ²	DIMMING		
VO2RRWW									
VO2RRWW - Voila 2" Round Recessed Wall Wash	TRM - Flanged trim TLMP - Trimless drywall mudplate TLMW - Trimless millwork	SW - Static white	OF - Open frame type non-IC IC - IC rated CP - Chicago Plenum type-IC (CCEA)	ACB - Adjustable commercial bar hangers (grid and drywall) ASB - Adjustable standard bar hangers (grid and drywall) FMB - Flush mount bars (drywall only) AHC - Adjustable hat channel bars	120 - 120V UNV - 120V-277V 347 ¹ - 347V ¹ Available with remote 0-10V dimming options RD1 and RSD1 only. Consult factory for details.	7W - Low output 775 lm 10W - Medium output 953 lm 14W - High output 1157 lm ² For delivered lumens and other CRI, see multiplier tables on page 3.	INTEGRAL D1 - 1% 0-10V ELV ³ - ELV 120V TRI ³ - TRIAC 120V ³ Available with 120V only.	REMOTE RD1 - 1% 0-10V RELV ⁴ - ELV 120V RTRI ⁴ - TRIAC 120V RLDEI ⁵ - Lutron Hi-lume 1% Eco RDA ⁵ - DALI RELDO - eldoLED 0.1% RELD1 - eldoLED 1% ⁴ Available with 120V only. ⁵ On-site commissioning is required.	+EB ⁶ - Emergency battery ⁶ Specify with remote dimming only. The code will be like the following example: RD1 + EB .
		SOLA - Dim-to-warm DUO - Tunable white					SOLA SD1 - Single 0-10V input DUO RDMX ⁵ - To specify, see pages 7 to 9 RDDA ⁵ - DALI RDD1 - Dual 0-10V input for CCT/Intensity RLD2 ⁵ - Lutron DALI- 2 digital		

2 - Light (Example: VO2WW-SW-WW-2-90-27)

LUMINAIRE ID	LIGHT SOURCE	BEAM	COLOR QUALITY	CRI	COLOR TEMP
VO2WW		WW			
VO2WW - Voila 2" Wall Wash	SW - Static white	WW - Wall wash	2 - 2 Step MacAdam Ellipse	90 - 90 CRI 80 - 80 CRI 97 - 97 CRI (not available for 3500K)	27 - 2700K 30 - 3000K 35 - 3500K 40 - 4000K
	SOLA - Dim-to-warm DUO - Tunable white		3 - 3 Step MacAdam Ellipse	90 - 90 CRI (SOLA and DUO)	SOLA - Dim-to-warm 35K-22K DUO - Tunable white 27K-65K

3 - Baffle (Example: VO2RRB-TRM-WW-SR-TMW-TMW)

LUMINAIRE ID	TRIM STYLE	LENS	BAFFLE POSITION	BAFFLE FINISH	TRIM FLANGE FINISH
VO2RRB		WW	SR		
VO2RRB - Voila 2" Round Recessed Baffle	TRM - Flanged trim TLMP - Trimless drywall mudplate TLMW - Trimless millwork	WW - Wall wash diffuser	SR - Standard regress	TMW - Textured matte white TMB - Textured matte black CF# - Custom finish, specify RAL# (e.g. CF1028)	TMW ⁷ - Textured matte white TMB ⁷ - Textured matte black CF# ⁷ - Custom finish, specify RAL# (e.g. CF1028) NA - None
					⁷ Applicable for TRM only.

Photometrics

Please follow the multiplier tables to ensure correct lumen value. Baffle color, CCT, CRI and baffle shape will change the lumen value.

24" from Wall - 36" Spacing

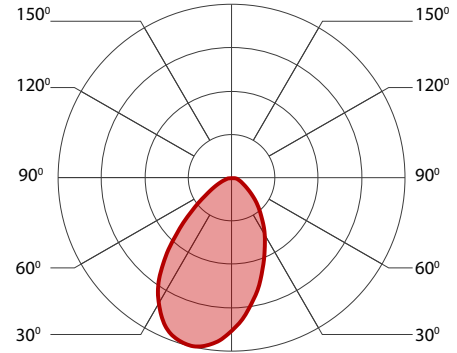
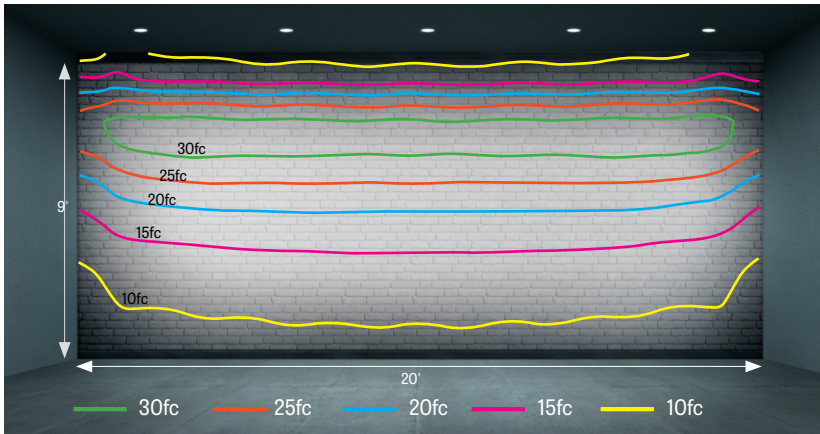

Foot-Candles for Round White Wall Wash Baffles

FC ON WALL 24" FROM WALL - 24" SPACING				24" FROM WALL - 36" SPACING			24" FROM WALL - 48" SPACING			
DISTANCE FROM CEILING		80 CRI (At 35K)	90 CRI (At 35K)	97 CRI (At 30K)	80 CRI (At 35K)	90 CRI (At 35K)	97 CRI (At 30K)	80 CRI (At 35K)	90 CRI (At 35K)	97 CRI (At 30K)
	3"	13	12	10	9	8	7	8	7	6
	6"	16	14	12	11	10	9	9	8	7
	12"	21	18	15	14	13	11	12	11	9
	2'	45	40	34	31	27	23	25	22	19
	3'	52	46	40	35	30	26	27	24	21
	4'	43	38	33	29	25	22	22	19	16
	5'	33	29	25	22	20	17	16	15	13
	6'	27	23	21	17	15	13	13	11	9
	7'	21	19	16	14	13	11	10	9	8
8'	18	16	14	12	11	9	8	8	6	

Delivered Lumens

CRI	80 CRI (At 35K)	90 CRI (At 35K)	97 CRI (At 30K)
Low - 7 W	775	720	619
Medium - 9.8 W	953	886	762
High - 13.8 W	1157	1076	925

Efficacy Based on Delivered High Lumens - 13.8 W

	LPW
80 CRI	84
90 CRI	78
97 CRI	67

Multiplier - CCT

CCT	Multiplier
2700K	0.9
3000K	0.95
3500K	1
4000K	1.05

Multiplier - Baffle Color and Shape

BAFFLE VARIABLES		
White	Round	1
White	Square	1
Black	Round	0.95
Black	Square	0.95

For SOLA and DUO, please consult factory.

Technical Specification

DESCRIPTION Compact fixed or adjustable 2" downlight with multiple output, color, beam, and dimming options.

HOUSING CONSTRUCTION For new construction, 20 gauge powder coated steel. Open frame, type-IC, or Chicago Plenum (CEA) rated. 18 gauge galvanized steel junction box with ½" trade size knockouts. Adjustable hanger bars and butterfly brackets are included. Hat channel and flush mounted brackets are also available.

Clearance Height: Open frame 4", IC and Chicago Plenum 4"

Ceiling Thickness: Can accommodate ½" to 1"

Housing weight: Type-IC/Chicago Plenum -7.5 lbs -3.4 kg

Open Frame - 5.5 lbs -2.5 kg

Ceiling cut out: 3 ¾" for square and round

FIELD REPLACEABLE LIGHT ELEMENT

Adjustability: Hot aiming, lockable, 360° rotation and 30° vertical tilt

LED Module: Integral COB module. 90 CRI and 2 SDCM, Standard with options of 80 CRI, or 97 CRI. L80 > 60,000 hours

Light Output: From 775-1157 lumens

HyFlex™ Optics: Proprietary TIR/reflector with field interchangeable beam smoothing lenses.

Optical Accessories: Linear spread lens, hex cell louver, color filters, can accommodate up to two in the light element.

Thermal Management: Cold-forged aluminum heat sink to maximize thermal dissipation.

BAFFLE

Die-cast aluminum retained ½" or 1" deep with rare earth magnets.

Trim style options: Round and square with flanged trim, trimless with mudplate for drywall, or trimless for millwork.

CHROMAWERX SOLA (dim-to-warm) and DUO (tunable white). See pages 6 for more information.

ELECTRICAL

Integral: 0-10V, ELV, TRIAC.

Remote: 0-10V, ELV, TRIAC, Lutron Hi-Lume EcoSystem, DALI, eldoLED 0.1%, eldoLED 1%, DMX, Lutron DALI- 2 digital.

Emergency Options: Bodine emergency battery back-up is installed remotely. For 7W or 10W fixtures, battery provides 6W of power. For 14W fixtures, battery provides 10W of power.

ENVIRONMENT Ambient temperature at fixture location shall be within 0°C/32°F - 25°C/77°F, indoor dry or damp as well as outdoor damp use (canopies or marquees).

LISTING cETLus listed to UL 1598 and CAN/CSA Standard C22.2 No. 250.0

WARRANTY 5 year limited warranty on LED module and power supply. Guaranteed to maintain 70% lumen maintenance.

Installation Types

Open Frame

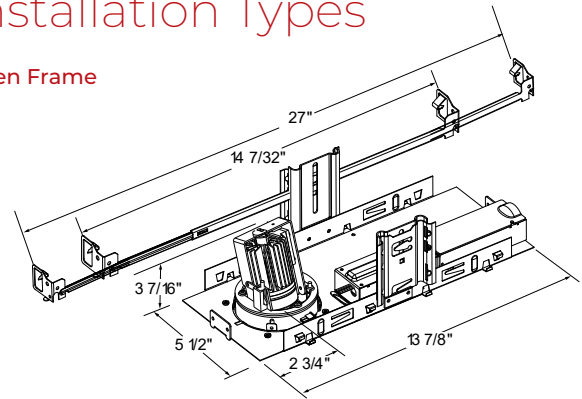

Type-IC / Chicago Plenum

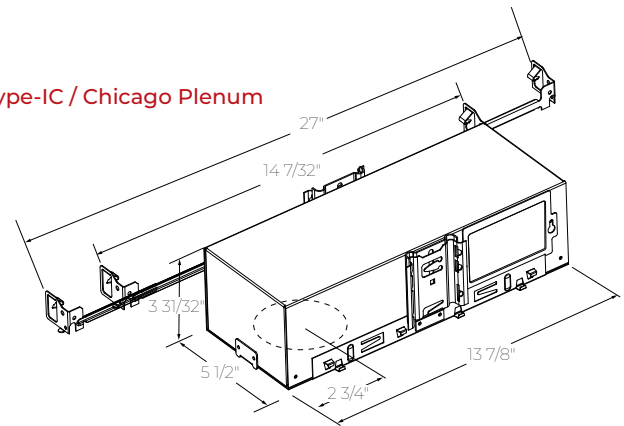

Mounting Options

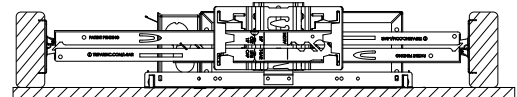

ACB - Adjustable Commercial Bar Hangers

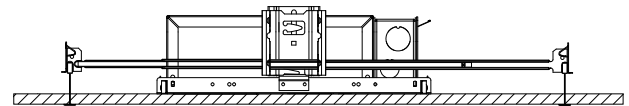

ASB - Adjustable Standard Bar Hangers

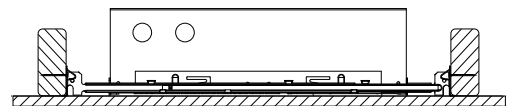

FMB - Flush Mount Bars

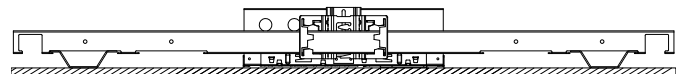

AHC - Adjustable Hat Channel Bars

Voilà

True 2" Round Downlight
Wall Wash

LUMENWERX

Project: _____

Type: _____

Light

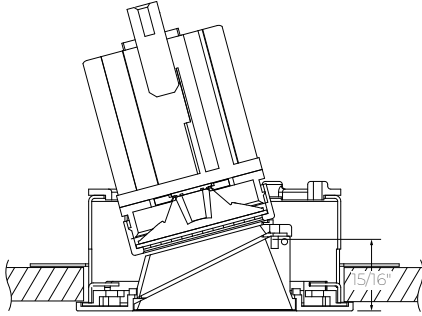

Standard Baffle

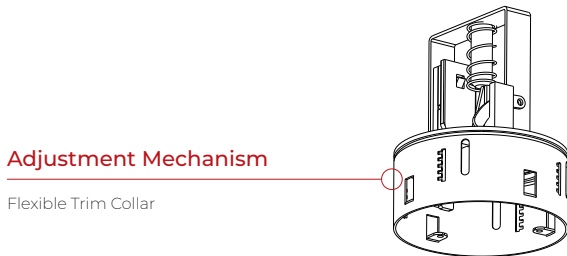

Adjustment Mechanism

Flexible Trim Collar

Light Element

Heat Sink
LED Module
Hyflex Optics

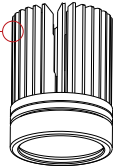

Retaining Ring

Magnetic Snap

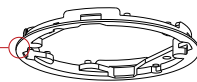

Baffle & Lens

Standard Regress
Wall Washer Lens

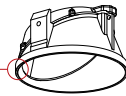

Trim

Trim and Trimless

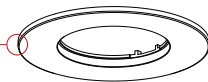

Optics

Hyflex™ optics provide precise optical control in a remarkably compact form. The core of this four-tier system is a compound reflector with a central TIR element, just 1.06" deep.

Light Source - LED

Compact COB (Chip-On-Board) LED module, available in 2700K, 3000K, 3500K and 4000K with a choice of 80 CRI or 90 CRI with elevated R9 value (for 97 CRI, consult factory). Color consistency is maintained to within 2 SDCM. All LEDs have been tested in accordance with IESNA LM-80-08 and the results have shown L80 lumen maintenance greater than 60,000 hours. Absolute product photometry is measured and presented in accordance with IESNA LM-79, unless otherwise indicated.

Beam Angles



Wall Wash

Integral Driver

Unless otherwise specified, Voilà comes standard with an integral, 120-277VAC/60Hz, electronic, 1% 0-10V dimming, constant-current LED driver. The driver is field replaceable and features a high power factor, low THD and sources 1 mA on the 0-10V dim line. All integral drivers are located inside the housing and are easily accessible from below the ceiling through the aperture. All dimming drivers comply with IEEE C62.41 surge protection requirements.

Emergency Remote

Long-life, high-temperature, emergency LED driver with Lithium Ion battery pack. Features a test switch with charge indicator, minimum of 90 minutes operation. For 7W or 10W fixtures, battery provides 6W of power. For 14W fixtures, battery provides 10W of power. Recharge time of 24 hours.

Voilà

True 2" Round Downlight
Wall Wash

LUMENWERX

Project: _____

Type: _____

Trim Dimensions

Trimless

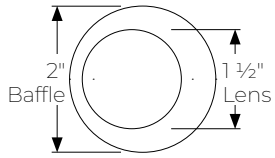

Trim

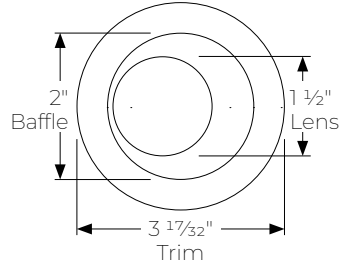

Chromawerx Sola is single-channel control that dims output while warming the color temperature in a pre-determined relationship. A simple or analog control adjusts a specially populated LED array to emulate the effect of dimming a filament source.



Chromawerx Duo offers a two-channel control system which uses analog or digital protocols for synchronous control of both warm (2700K) to cool (6500K) LED arrays - maintaining a CRI above 90. The range of color DUO offers is useful for entraining circadian rhythms, stimulating alertness, and compensating for jet lag among other applications. The Chromawerx drivers are programmed to limit maximum light output and power usage across all color temperatures.

Baffle



Standard Regress

Trimless



Black Baffle

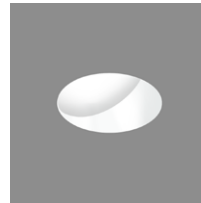

White Baffle

Trim

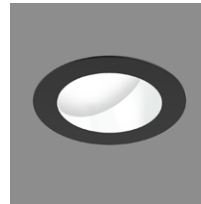

White Baffle,
Black Trim



Black Baffle,
White Trim

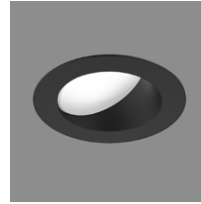

Black Baffle,
Black Trim

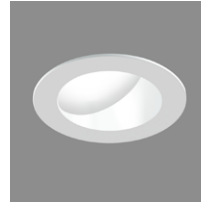

White Baffle,
White Trim

DUO GENERIC DMX NETWORK ARCHITECTURE

A qualified DMX integrator is required to assure proper installation and commissioning of the DMX network. **When placing the PO, please provide the contact information of your DMX integrator.**

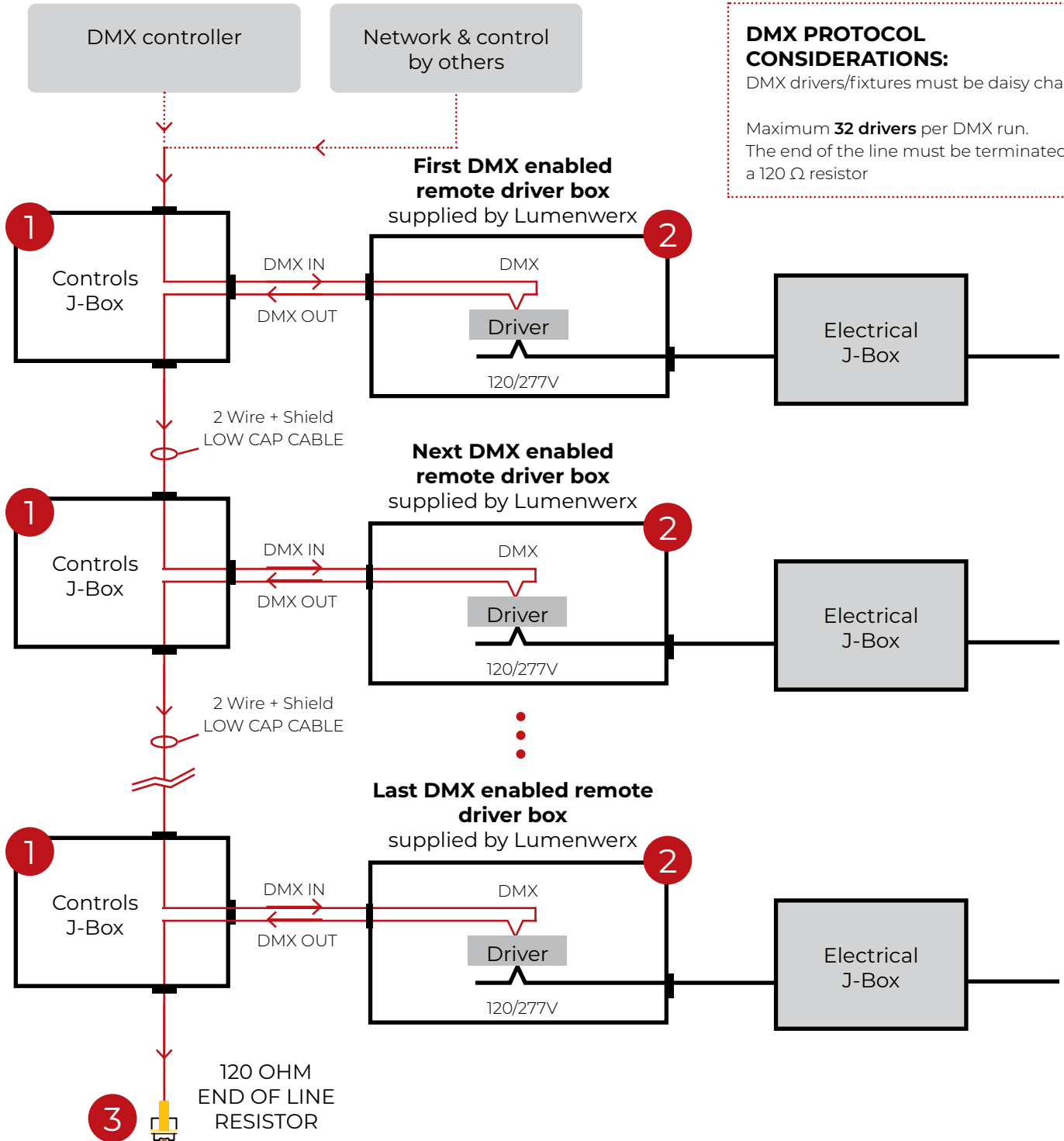

DMX PROTOCOL CONSIDERATIONS:
DMX drivers/fixtures must be daisy chained.

Maximum **32 drivers** per DMX run.
The end of the line must be terminated by a 120 Ω resistor

1 J-BOX DMX DAISY CHAIN DETAIL

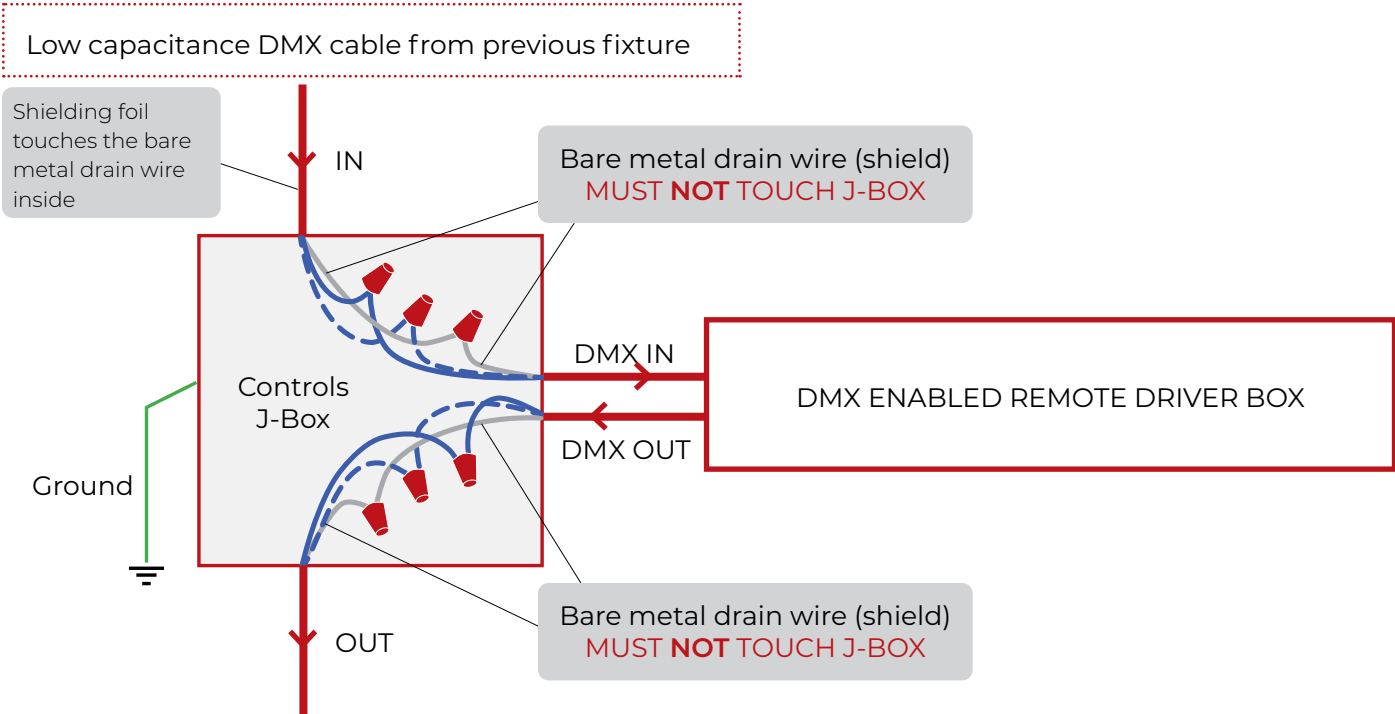

Low capacitance DMX cable to next fixture

2 DMX CONNECTION REMOTE DRIVER

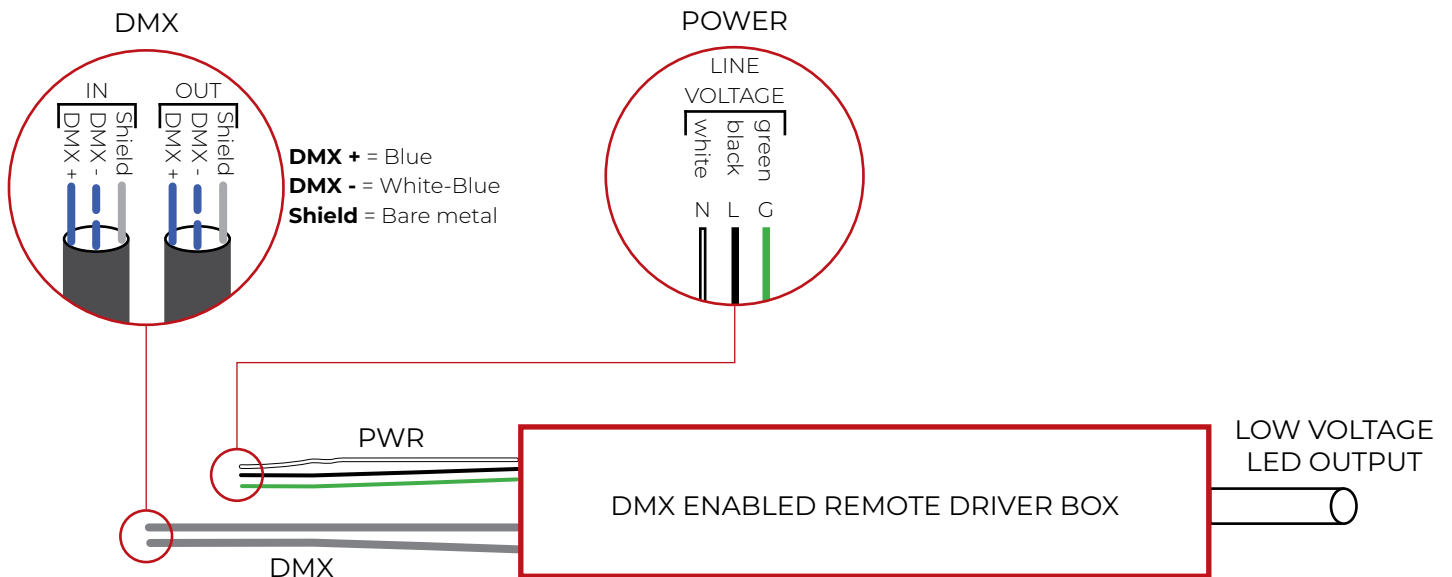

3 LAST DMX CONNECTION DETAIL

