

ARRO 2

PENDANT
STATIC WHITE, FULL SPECTRUM



LUMENWERX

Project: _____

Type: _____



DESCRIPTION

Visual interest and versatility come together in Arro, our family of pendants easily recognizable by their triangular prism form. Despite its compact 2" base and height, Arro 2 is big with offerings including Direct distribution, continuous-run capacity with maximum 8' segments, three stylish forms (rectangle, square, and triangle), and both X and Y spokes.

SENSORS
For latest information on sensors, click [here](#).



Order Guide

LUMINAIRE ID	DISTRIBUTION	DIRECT OPTIC	LIGHT SOURCE ¹	CRI	LUMEN PACKAGE
ARR2P	D	HLO			
ARR2P - Arro 2" Pendant	D - Direct	HLO - High-Efficiency Lambertian Optic	SW - Static white FS - Full spectrum ¹ Chromawerx SOLA and DUO also available. Consult factory for details.	80CRI ² - 80 CRI 90CRI ² - 90 CRI 95CRI - 95 CRI ² Not available with full spectrum	350LMF - Low output 350 lm/ft 500LMF - Medium output 500 lm/ft 750LMF ³ - High output 750 lm/ft ³ Not available with full spectrum.

COLOR TEMP.	LUMINAIRE LENGTH ⁴	VOLTAGE	DRIVER ⁷	ELECTRICAL
				1C
27K - 2700K 30K - 3000K 35K - 3500K 40K - 4000K	#FT ⁵ - Specify nominal length (#) ¹ increments Standard nominal lengths: Single units: 2' - 8' Continuous runs: lengths over 8' ⁴ Square, Rectangle, Triangle, Y and X Spoke shapes also available. For details, see the Shapes spec sheet. ⁵ Minimum 2'.	120V - 120V 277V - 277V UNV - 120V-277V 347V ⁶ - 347V ⁶ Available with D1 only.	CANOPY DRIVER ⁸ D1 - 1% 0-10V DA ⁹ - DALI LTEA2W ¹⁰ - Lutron 1% - 2 wire FP 120V LDE1 ⁹ - Lutron Hi-lume 1% Eco ELD1 - eldoLED 1% ECOdrive 0-10V ELDO - eldoLED 0.1% SOLOdrive 0-10V ⁷ PoE (Power-over-Ethernet) compatible. Consult factory for details. ⁸ Not available with RDB driver box option. ⁹ On-site commissioning is required. ¹⁰ Available with 120V only. ¹¹ Not available with LCD driver box option.	REMOTE DRIVER ¹¹ RDI - 1% 0-10V RDA ⁹ - DALI RLTEA2W ¹⁰ - Lutron 1% - 2 wire FP 120V RLDE1 ⁹ - Lutron Hi-lume 1% Eco RELD1 - eldoLED 1% ECOdrive 0-10V RELDO - eldoLED 0.1% SOLOdrive 0-10V 1C - 1 circuit

MOUNTING			FINISH		OPTIONS
DRIVER BOX ¹² LCD ^{13,14} - Linear canopy driver box RDB - Remote driver box ¹² For more information see page 3. ¹³ Canopy size may vary based on fixture length, color temperature, CRI and lumen package. ¹⁴ LCD is not available with 347V.	CANOPY FINISH W - Matte white AL - Aluminum B - Matte black CF# - Custom finish, specify RAL#	POWER POC ¹⁵ - Integrated suspension power-over-aircraft cable BAC - Black power cord + aircraft cable WAC - White power cord + aircraft cable ¹⁵ For more information see page 3.	HEIGHT ##IN - Distance from the canopy to the fixture in inches	W - Matte white AL - Aluminum B - Matte black CF# - Custom finish, specify RAL#	FU120 - Fuse 120V FU277 - Fuse 277V NA - None

[For all other options refer to our Pendant Mounting Guide](#)

ARRO 2

PENDANT
 STATIC WHITE, FULL SPECTRUM

LUMENWERX

Dimensions

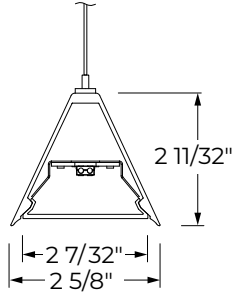

Direct

Fixture Lengths

NOMINAL LENGTH	FIXTURE LENGTH A
2'	24 3/8"
3'	36 3/8"
4'	48 3/8"
5'	60 3/8"
8'	96 3/8"

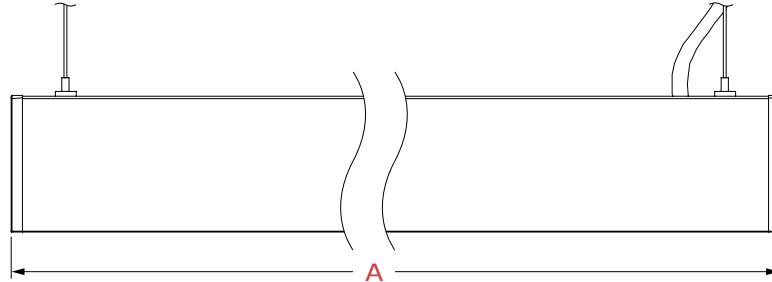

Photometrics

Values calculated based on a 4 ft fixture at 35K and 80 CRI for all optics.

DIRECT

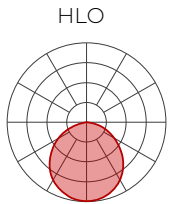

LM/FT	W/FT	LPW
350	3.3	107
500	4.8	105
750	7.4	101

MULTIPLIER TABLES

Use these tables to get results for different color temperatures, and CRI for all Direct and Indirect photometric tables.

CCT (K)	WATTS		LPW	
	CRI 80	CRI 90	CRI 80	CRI 90
2700	1.05	1.27	0.95	0.79
3000	1.02	1.23	0.98	0.81
3500	1.00	1.19	1.00	0.84
4000	1.00	1.19	1.00	0.84

ARRO 2

PENDANT
STATIC WHITE, FULL SPECTRUM

LUMENWERX

Mounting Options

LINEAR CANOPY DRIVER BOX

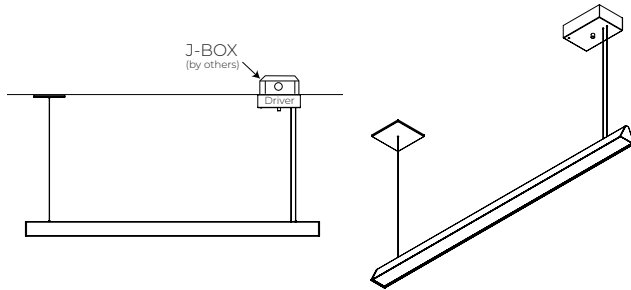

POWER-OVER-AIRCRAFT CABLE

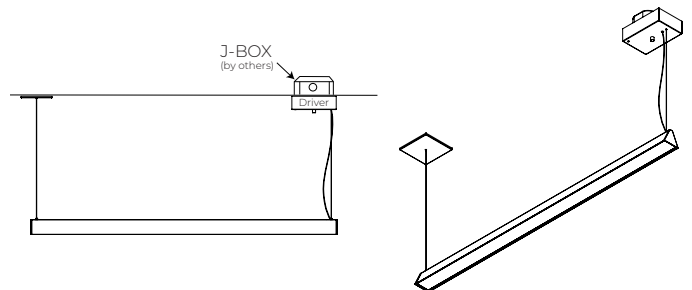

POWER CORD + AIRCRAFT CABLE

REMOTE DRIVER BOX

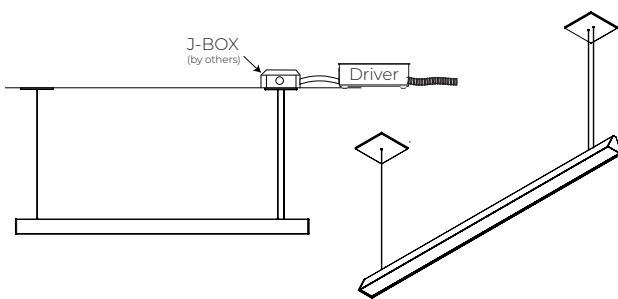

POWER-OVER-AIRCRAFT CABLE

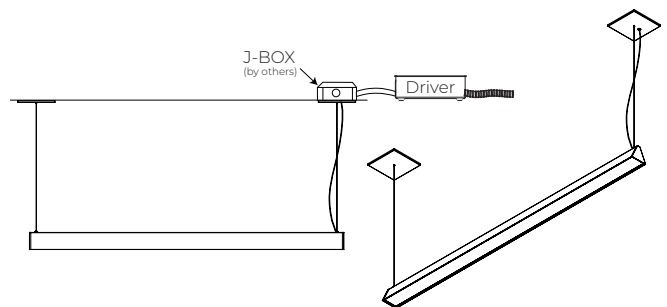

POWER CORD + AIRCRAFT CABLE

ARRO 2

PENDANT

STATIC WHITE, FULL SPECTRUM

LUMENWERX

Technical Specifications

DIRECT OPTIC

High-Efficiency Lambertian Optic (HLO)

The High-Efficiency Lambertian Optic (HLO) shielding of diffusing 0.075" thick acrylic with up to 88% transmission and good source obscuration is combined with matte white side reflectors to create an efficient optical chamber with uniform luminosity. Luminaire brightness is controlled by the flux-to-shielding area ratio.

LIGHT SOURCE

Custom array of mid-flux LEDs are mounted directly to the housing for optimal thermal performance. Available in 2700K, 3000K, 3500K, and 4000K with a minimum 80 CRI and an option for 90 CRI with elevated R9 value. Color consistency maintained to within 3 SDCM. LEDs operated at reduced drive current to optimize efficacy and lumen maintenance. All LEDs have been tested in accordance with IESNA LM-80-08 and the results have shown L80 lumen maintenance greater than 60,000 hours. Absolute product photometry is measured and presented in accordance with IESNA LM-79, unless otherwise indicated. Optional full spectrum LEDs can be incorporated in the fixture to increase Cyanosis Observation Index (COI) and assist in regulating circadian rhythms.



WELL for Light - The WELL building standard focuses on light quality in several features. There are three categories that are fully attributed to the construction and features of a luminaire. In WELL V1, it's Feature 54 Circadian Lighting, Feature 55 Glare Control, and Feature 58 Color Quality. In WELL V2, it's Feature L03 Circadian Lighting, Feature L04 Glare Control, and Feature L07 Electric Light Quality.

This fixture meets Features:

- Feature 54 or L03 when Full Spectrum is selected
- Feature 58 or L07 when 90CRI or above is selected

All LED drivers used at Lumenwerx are deemed to have a low risk level of flicker, of 5 % or less below 90Hz operational as defined by IEEE standard 1789-2015 LED.



WELL for Mind -This luminaire meets WELL for mind as it is a human centric luminaire offering quality light, excellent color, and smooth optics. If any of these features are incorporated in a luminaire, it can improve the ability to focus, concentrate, and persist longer on a given task. This fixture harmoniously operates in a space to assist the mind.

For more information, please contact well@lumenwerx.com

LUMINAIRE LENGTH

Arro is available in standard lengths of 2' to 8'. Continuous runs are available for run lengths over 8'. Exact run length must be noted in the product code. The minimum length is 2', and can be ordered in 1' increments.

All individual sections are joined together onsite using the joiner kits provided. Lumenwerx offers joiner kits that are extremely simple to work with in the field and result in a fixture that appears virtually seamless with no light leak at any connection.

ELECTRICAL

Factory-set, adjustable output current LED driver with universal (120-277VAC) input. Dimmable from 100% to 1% with 0-10V dimming control. Rated life (90% survivorship) of 50,000 hours at 50°C max. ambient (and 70°C max. case) temperature. At maximum driver load: Efficiency>84%, PF>0.9, THD<20%. Other specifiable options include Lutron Hi-Lume 1% (specify 2-wire, or Ecosystem Dim-to-Off), eldoLED ECOdriver 0-10V, eldoLED SOLOdriver 0-10V, DALI protocol drivers. All of our standard 0-10V drivers are NEMA 410 compliant.

PoE

Depending on the PoE manufacturer selected, Lumenwerx will install the node in factory as either integral to the luminaire or as a remote module. Factory programming of the PoE node may or may not enable the following functionalities: lumen package, DUO (tunable white), emergency battery backup, and sensor integration. These must be addressed and evaluated on a case-by-case basis.

FINISH

Interior - 95%, reflective matte powder coated white paint

Exterior - Matte white, matte black, or aluminum powder coating. Custom finishes are also available.

ARRO 2

PENDANT

STATIC WHITE, FULL SPECTRUM

LUMENWERX

CONSTRUCTION

Housing - Extruded aluminum (0.070" nominal) up to 90% recycled content

Joiner - Galvanized steel

Reflector - Cold rolled steel 24 gauge thick

HLO lens - PMMA

End caps - Die cast aluminum

Hanger - Chromed griplock securely attached in end caps and/or joiners with stainless steel hardware

Aircraft cable suspension - 7x7 braids stainless steel aircraft cable 0.05" thick

WEIGHT

2' - 2.17 lbs - 1.00 kg

4' - 4.35 lbs - 1.97 kg

6' - 6.52 lbs - 2.96 kg

8' - 8.69 lbs - 3.94 kg

CERTIFICATION

ETL - Rated for Indoor Dry/Damp locations. Conforms to UL Standard 1598 and certified to CAN/CSA Standard C22.2 No. 250.0.

WARRANTY

Lumenwerx provides a five-year limited warranty of electrical and mechanical performance of the luminaires, including the LED boards, drivers, and auxiliary electronics. Lumenwerx will repair or replace defective luminaires or components at our discretion, provided they have been installed and operated in accordance with our specifications. Other limitations apply, please refer to the full warranty on our website.