

# CAVA SQUARE LED

PENDANT DIRECT/INDIRECT

**LUMENWERX**  
WWW.LUMENWERX.COM

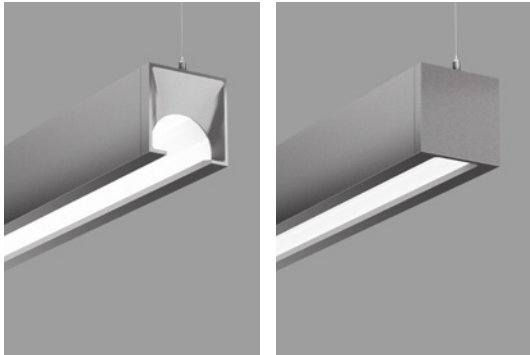

Shown with open end cap    Shown with closed end cap

## DESCRIPTION

**Cava** is a linear LED recessed, surface and pendant luminaire with a remarkably comfortable and surprising appearance. Using completely concealed and indirect LED arrays, Cava provides superior brightness control, while maintaining high efficacy by distributing light over the vaulted interior cavity of the luminaire. See separate spec sheets for other available design and mountings.



PROJECT: \_\_\_\_\_

TYPE: \_\_\_\_\_

NOTES: \_\_\_\_\_

## ORDER GUIDE

**up to 130 lm/W performance**

CAVSPDI		RLO		SW		
LUMINAIRE ID	END CAP	DIRECT OPTIC	INDIRECT OPTIC	LIGHT SOURCE	CRI	DIRECT LUMEN PACKAGE
CAVSPDI - Cava square pendant direct/indirect	OP - open end cap CO - closed end cap	RLO - Reduced Luminance Optic	CLO - Clear Lambertian Optic WIO2 - Widespread Indirect Optic	SW - Static white	80 - 80CRI 90 - 90CRI	350 - min. low output 350lm/ft 500 - medium output 500lm/ft 750 - max. high output 750lm/ft #### - other required lm/ft

INDIRECT LUMEN PACKAGE	COLOR TEMP.	LUMINAIRE LENGTH	VOLTAGE	DRIVER
500 - min. low output 500lm/ft 750 - max. medium output 750lm/ft #### - other required lm/ft	27 - 2700K 30 - 3000K 35 - 3500K 40 - 4000K	Standard sections - 3', 4', 5', 8' & 12' For all other specify length #FT - nominal length in feet Continuous Run - for luminaires over 12'	120 - 120V 277 - 277V UNV - 120V-277V 347 <sup>1</sup> - 347V <sup>1</sup> Only available with D1 driver.	D1 - 1% 0-10V DA <sup>2</sup> - DALI LTEA2W - Lutron 1% - 2 wire FP 120V LDE1 <sup>2</sup> - Lutron Hi-lume 1% Eco <sup>2</sup> On-site commissioning is required.

ELECTRICAL	MOUNTING	FINISH	CONTROLS	OPTIONS
1 - 1 circuit 2 - 2 circuits +#EB <sup>3,4</sup> - emergency battery +#EM - emergency light circuit +#NL - night light circuit +GTD <sup>4</sup> - generator transfer device <sup>3</sup> Minimum 4' fixture for Lutron. <sup>4</sup> Not available with 347V.	53WAC36 - power 5" + non power 3" white canopy (36" aircraft cable) 55WSW18 - power 5" + non power 5" white canopy & stem (18" stem) <a href="#">For all other options refer to our Pendant Mounting Guide</a>	W - matte white AL - aluminum B - matte black CF# - custom finish, specify RAL#	<b>STANDALONE CONTROLS</b> OMS - Onboard Occupancy ODS - Onboard Daylight OCS - Onboard Occupancy & Daylight <b>CONNECTED CONTROLS</b> CCS() - LU-Lutron, EN-Enlighted, OS-Osram To specify see information on page 2-3	FU120 - Fuse 120V FU277 - Fuse 277V TB# - T-bar caddy clip specify grid size TG# - Tegular caddy clip specify grid size ST - Screw Slots caddy clip NA - None

## CROSS SECTION

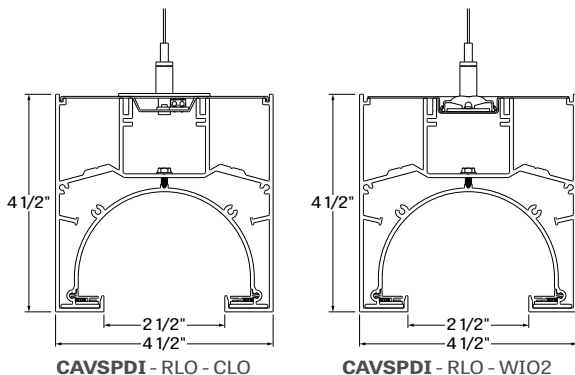

## OPTICS

**REDUCED LUMINANCE OPTIC (RLO)** - reduced Luminance Optic (RLO) consists of indirect-mounted LED arrays illuminating a vaulted reflector with a matte white finish greater than 95% reflectivity. The ultra-shallow arrays in RLO completely conceal the light source while evenly distributing brightness over the entire surface of the cavity using a combination of multiple reflective bounces and a very high diffuse reflectivity. Compared to diffusing optics, RLO reduces luminaire brightness due to the visible interior surface being larger than the aperture.

## LIGHT SOURCE - LED

Custom linear array of mid-flux LEDs are cartridge-mounted with quick-connect wiring to facilitate service and thermal management. Available in 2700K, 3000K, 3500K and 4000K with a minimum 80 CRI and an option for 90 CRI with elevated R9 value. Color consistency maintained to within 3 SDCM. LEDs operated at reduced drive current to optimize efficacy and lumen maintenance. All LEDs have been tested in accordance with IESNA LM-80-08 and the results have shown L80 lumen maintenance greater than 60,000 hours. Absolute product photometry is measured and presented in accordance with IESNA LM-79, unless otherwise indicated.

## LUMINAIRE LENGTH

Cava is made up of standard 3, 4, 5, 8 and 12 foot sections that may be joined together to create longer continuous run lengths. Nominal run length must be noted in the product code. The minimum individual section available is 3 feet. All individual sections are joined together onsite using the joiner kits provided. Lumenwerx offers joiner kits that are extremely simple to work with in the field and result in a fixture that appears virtually seamless with no light leak at any connection.

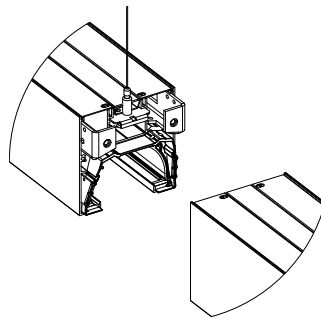

joining system for Cava square

## ELECTRICAL

Factory-set, adjustable output current LED driver with universal (120-277VAC) input. Dimmable from 100% to 1% with 0-10V dimming control. Rated life (90% survivorship) of 50,000 hours at 50°C max. ambient (and 70°C max. case) temperature. At maximum driver load: Efficiency > 84%, PF > 0.9, THD < 20%. Other specifiable options include Lutron Hi-Lume 1% (specify 2-wire, or Ecosystem Dim-to-Off), and DALI protocol drivers. All of our standard 0-10V drivers are NEMA 410 compliant.

## EMERGENCY

Factory installed long life, high temperature, maintenance-free Lithium-Ion battery pack with self-test functionality, test switch and charge indicator. Minimum of 90 minutes operation, up to 10W (25°C) emergency lighting output and recharge time of 24 hours.

## MOUNTING OPTIONS

Fixtures can be pendant-mounted, using aircraft cables, or stem-mounted.

Unless otherwise specified, Lumenwerx provides the following hardware:

**For cable-mounted fixtures** - 53WAC36 (5" white canopy for all power mounting point, 3" white canopy for non power mounting point, and a 36" cable)

**For stem mounted fixtures** - 55WSW18 (5" white canopy for all power mounting point, and non power mounting point, and a 18" white stem)

**Caddy clips**, if required specify under **OPTIONS**

[For all other options, see our website for a detailed Pendant Mounting Guide](#)

## FINISH

**Interior** - 95%, reflective matte powder coated white paint

**Exterior** - matte white, matte black or aluminum powder coating.

Custom finishes are also available.

## CONTROLS

Lumenwerx offers several options for integrating occupancy and daylight harvesting controls in our luminaires.

## STANDALONE CONTROLS

An integrated standalone sensor controls the luminaire in which it is installed. Depending on the length, more than one sensor may be necessary and may control the entire luminaire, or just a section of it. These controls operate independently. Unless otherwise agreed, location and functionality of the sensor within the luminaire are selected by Lumenwerx.

Three types are available:

**OMS:** An integral Passive InfraRed (PIR) sensor turns luminaires on and off automatically with field-adjustable time out period. No wall control is used. Coverage pattern for large motion has a 12' diameter with the sensor mounted 8' above the floor; for small motion, the pattern has an 8' diameter. Typically, one sensor is required for every 10' of a continuous luminaire run.

# CAVA SQUARE LED

PENDANT DIRECT/INDIRECT

**LUMENWERX**  
W W W . L U M E N W E R X . C O M

**ODS:** An integral, daylight harvesting sensor with closed-loop operation dims the luminaire in which it is installed in order to compensate for available daylight. The sensor measures the combination of daylight and luminaire light reflected from horizontal surfaces below the luminaire. Initial onsite calibration is required via the use of provided remote control.

**OCS:** Both an occupancy and a daylight sensor are installed in the luminaire.



Location of an Onboard control

## CONNECTED CONTROLS

With Connected Controls, sensors or nodes installed in the luminaire form part of a larger control system infrastructure from manufacturers such as: Lutron\*, Enlighted, Osram ENCELIUM, Acuity nLight, and others. These connected controls allow for a scalable system providing features like occupancy and daylight control, manual control, scheduling and configuration of various zones and scenes. Energy reporting and system monitoring are also possible. Specific capabilities depend on the control system being used.

Lumenwerx installs the components (sensors, nodes, power packs, etc) which may be supplied to us by a third party, or procured directly by Lumenwerx, depending on the control system manufacturer.

Lumenwerx is solely responsible for the installation of specified components; the controls manufacturer is responsible for performance of the control system.

To indicate a Lumenwerx luminaire with Connected Controls, identify the specific onsite control system to be integrated into the luminaires using the ordering code. Due to the diversity of components, you must contact [controls@lumenwerx.com](mailto:controls@lumenwerx.com) to assure complete compatibility with intended control system and to fully specify the luminaire.

Complete control specifications, sensor/node/power pack layout, and narrative for the control system are required for Lumenwerx to create shop drawings and submittals.

\* Lumenwerx offers a Lutron Vive-Enabled fixture option using either the DFCSJ-OEM-OCC (OCS Option) or DFCSJ-OEM-RF (wireless only, no sensor) Integral Fixture Modules and a DALI or EcoSystem LED driver based on customer dimming requirements.

**Please contact our controls department at [controls@lumenwerx.com](mailto:controls@lumenwerx.com) for further assistance.**

## CONSTRUCTION

**Housing** - Extruded aluminum 0.075" nominal, matte white or aluminum powder coating.

Custom finishes are also available.

**End cap** - Die cast aluminum (0.95" nominal)

**Joiners** - Die cast aluminum (0.95" nominal)

**Reflectors** - Extruded aluminum 0.07" nominal, 95% reflective matte white painted

**Hanger** - Chromed griplock securely attached with spring steel hardware in end caps and/or joiners

**Air craft cable suspension** - 7x7 braids aluminum aircraft cable 0.06" thick

**Stem** - 0.5" diameter threaded steel tube matte white or aluminum powder coating. Custom finishes are also available.

## WEIGHT

**Cava square 4ft** - 14.10lbs - 6.4kg

**Cava square 8ft** - 27.53lbs - 12.5kg

**Cava square 12ft** - 40.97lbs - 18.6kg

## CERTIFICATIONS

**ETL** - Rated for Indoor Dry/Damp locations.

Conforms to UL Standard 1598 and certified to CAN/CSA Standard C22.2 No. 250.0.

## WARRANTY

Lumenwerx provides a five-year limited warranty of electrical and mechanical performance of the luminaires, including the LED boards, drivers, and auxiliary electronics. Lumenwerx will repair or replace defective luminaires or components at our discretion, provided they have been installed and operated in accordance with our specifications.

Other limitations apply, please refer to the full warranty on our website.

## PERFORMANCE AT INDIRECT CLO - 500 LUMEN PER FOOT

### DIRECT RLO - 350 LUMEN AT 80CRI - LOW OUTPUT

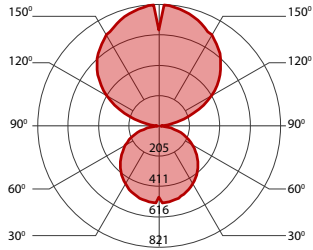

#### PERFORMANCE PER 4'

LED output	Color Temp	Watts	Direct Lumens	Indirect Lumens	Total Nominal Delivered Lumens	Efficacy LPW
low output	2700K	31	1400	2000	3400	109
low output	3000K	30.5	1400	2000	3400	112
low output	3500K	29.5	1400	2000	3400	115
low output	4000K	29	1400	2000	3400	118

### DIRECT RLO - 500 LUMEN AT 80CRI - MEDIUM OUTPUT

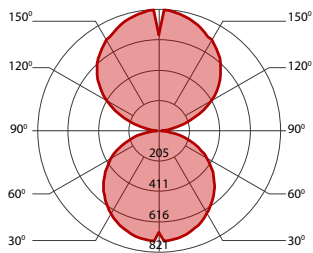

#### PERFORMANCE PER 4'

LED output	Color Temp	Watts	Direct Lumens	Indirect Lumens	Total Nominal Delivered Lumens	Efficacy LPW
medium output	2700K	37	2000	2000	4000	108
medium output	3000K	36	2000	2000	4000	111
medium output	3500K	35	2000	2000	4000	114
medium output	4000K	34	2000	2000	4000	117

### DIRECT RLO - 750 LUMEN AT 80CRI - HIGH OUTPUT

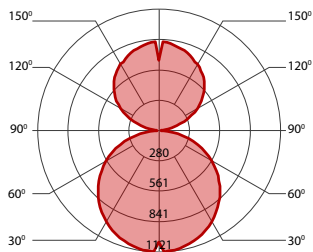

#### PERFORMANCE PER 4'

LED output	Color Temp	Watts	Direct Lumens	Indirect Lumens	Total Nominal Delivered Lumens	Efficacy LPW
high output	2700K	46.5	3000	2000	5000	108
high output	3000K	44.5	3000	2000	5000	112
high output	3500K	44	3000	2000	5000	114
high output	4000K	42.5	3000	2000	5000	118

## PERFORMANCE AT INDIRECT CLO - 750 LUMEN PER FOOT

### DIRECT RLO - 350 LUMEN AT 80CRI - LOW OUTPUT

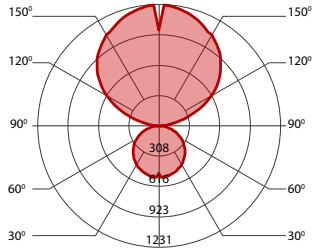

#### PERFORMANCE PER 4'

LED output	Color Temp	Watts	Direct Lumens	Indirect Lumens	Total Nominal Delivered Lumens	Efficacy LPW
low output	2700K	41	1400	3000	4400	107
low output	3000K	39.5	1400	3000	4400	111
low output	3500K	39	1400	3000	4400	113
low output	4000K	37.5	1400	3000	4400	117

### DIRECT RLO - 500 LUMEN AT 80CRI - MEDIUM OUTPUT

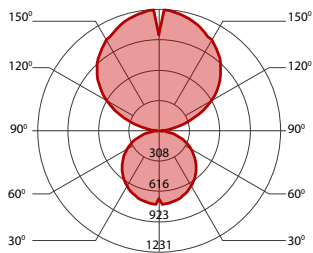

#### PERFORMANCE PER 4'

LED output	Color Temp	Watts	Direct Lumens	Indirect Lumens	Total Nominal Delivered Lumens	Efficacy LPW
medium output	2700K	46.5	2000	3000	5000	107
medium output	3000K	45.5	2000	3000	5000	110
medium output	3500K	44.5	2000	3000	5000	112
medium output	4000K	43	2000	3000	5000	116

### DIRECT RLO - 750 LUMEN AT 80CRI - HIGH OUTPUT

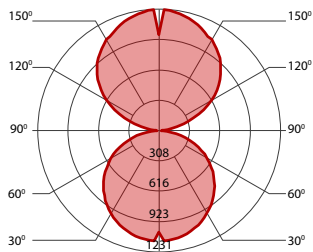

#### PERFORMANCE PER 4'

LED output	Color Temp	Watts	Direct Lumens	Indirect Lumens	Total Nominal Delivered Lumens	Efficacy LPW
high output	2700K	56	3000	3000	6000	107
high output	3000K	54	3000	3000	6000	111
high output	3500K	53	3000	3000	6000	113
high output	4000K	51.5	3000	3000	6000	117

## PERFORMANCE AT INDIRECT WIO2 - 500 LUMEN PER FOOT

### DIRECT RLO - 350 LUMEN AT 80CRI - LOW OUTPUT

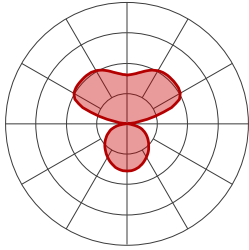

#### PERFORMANCE PER 4'

LED output	Color Temp	Watts	Direct Lumens	Indirect Lumens	Total Nominal Delivered Lumens	Efficacy LPW
low output	2700K	27.7	1400	2000	3400	123
low output	3000K	26.9	1400	2000	3400	127
low output	3500K	26.2	1400	2000	3400	130
low output	4000K	26.1	1400	2000	3400	130

### DIRECT RLO - 500 LUMEN AT 80CRI - MEDIUM OUTPUT

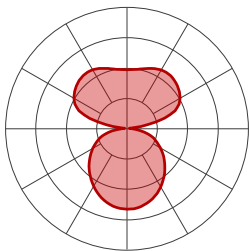

#### PERFORMANCE PER 4'

LED output	Color Temp	Watts	Direct Lumens	Indirect Lumens	Total Nominal Delivered Lumens	Efficacy LPW
medium output	2700K	33.5	2000	2000	4000	119
medium output	3000K	32.4	2000	2000	4000	123
medium output	3500K	31.7	2000	2000	4000	126
medium output	4000K	31.6	2000	2000	4000	127

### DIRECT RLO - 750 LUMEN AT 80CRI - HIGH OUTPUT

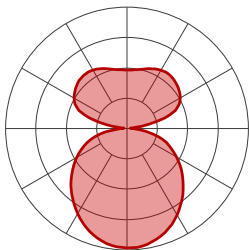

#### PERFORMANCE PER 4'

LED output	Color Temp	Watts	Direct Lumens	Indirect Lumens	Total Nominal Delivered Lumens	Efficacy LPW
high output	2700K	43.6	3000	2000	5000	115
high output	3000K	42.2	3000	2000	5000	119
high output	3500K	41.1	3000	2000	5000	122
high output	4000K	41	3000	2000	5000	122

## PERFORMANCE AT INDIRECT WIO2 - 750 LUMEN PER FOOT

### DIRECT RLO - 350 LUMEN AT 80CRI - LOW OUTPUT

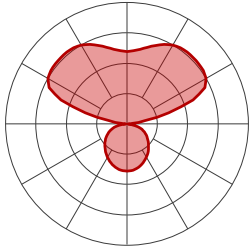

#### PERFORMANCE PER 4'

LED output	Color Temp	Watts	Direct Lumens	Indirect Lumens	Total Nominal Delivered Lumens	Efficacy LPW
low output	2700K	35.9	1400	3000	4400	122
low output	3000K	35.1	1400	3000	4400	126
low output	3500K	34.2	1400	3000	4400	129
low output	4000K	34.1	1400	3000	4400	129

### DIRECT RLO - 500 LUMEN AT 80CRI - MEDIUM OUTPUT

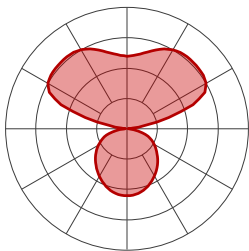

#### PERFORMANCE PER 4'

LED output	Color Temp	Watts	Direct Lumens	Indirect Lumens	Total Nominal Delivered Lumens	Efficacy LPW
medium output	2700K	41.8	2000	3000	5000	120
medium output	3000K	40.6	2000	3000	5000	123
medium output	3500K	39.6	2000	3000	5000	126
medium output	4000K	39.5	2000	3000	5000	127

### DIRECT RLO - 750 LUMEN AT 80CRI - HIGH OUTPUT

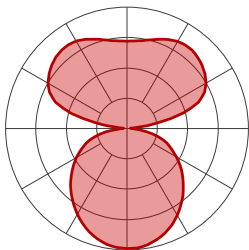

#### PERFORMANCE PER 4'

LED output	Color Temp	Watts	Direct Lumens	Indirect Lumens	Total Nominal Delivered Lumens	Efficacy LPW
high output	2700K	51.8	3000	3000	6000	116
high output	3000K	50.3	3000	3000	6000	119
high output	3500K	49.1	3000	3000	6000	122
high output	4000K	49	3000	3000	6000	123