

CLUSTER PI

RECESSED
MRO OPTIC

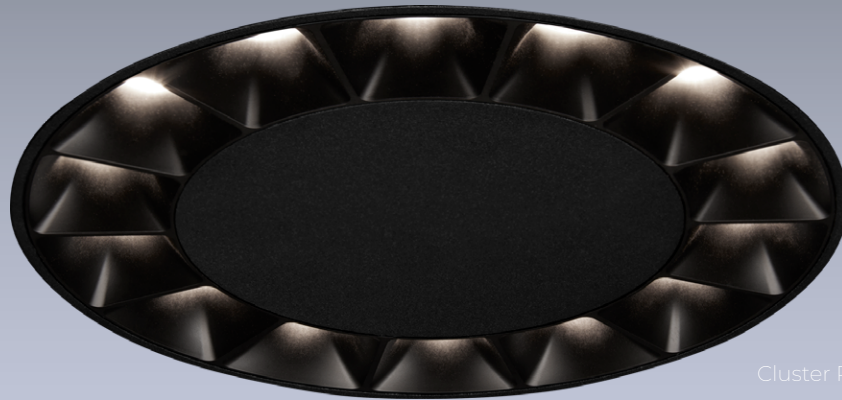

Cluster Pi M MRO

Cluster Pi with Miniature Reflector Optic (MRO) integrates the beauty and quality of our Cluster family into a fixture that illuminates through a circular array of light cells. The luminaire features a low profile of under 2" and can be recessed, surface, or pendant mounted. Of the three available sizes—Small (3.5"), Medium (6.5"), and Large (9")—the Medium and Large recessed models are designed to accommodate an add-on luminaire centrally positioned within its circular array.

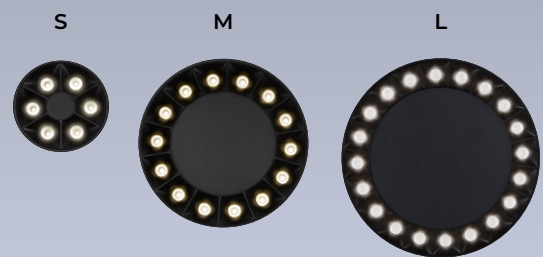

Cluster Pi Family (Refer to other spec sheets)

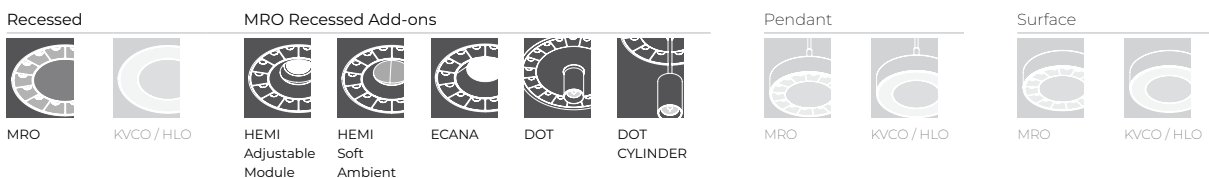

www.lumenwerx.com
T (514) 225-4304

© Lumenwerx, ULC. All rights reserved.



Lumenwerx reserves the right to modify product specifications without notification.

CLUSTER-PI-RECESSED-MRO-SPEC-REV1 January 24, 2024



CLUSTER PI

RECESSED

MRO OPTIC



Project: _____

Type: _____

Order Guide

1 - Housing



LUMINAIRE ID	TRIM STYLE	LIGHT SOURCE	INSTALLATION TYPE	MOUNTING OPTION ¹	VOLTAGE
		SW			
CLUPISR - Cluster Pi S Recessed CLUPIMR - Cluster Pi M Recessed CLUPILR - Cluster Pi L Recessed	TRM - Flanged trim TLMP - Trimless drywall mudplate TLMW - Trimless millwork	SW - Static white	OF - Open Frame Type Non-IC RM - Remodel Type Non-IC	ASB ² - Adjustable standard bar hangers FMB ² - Flush mount bars ACB ² - Adjustable commercial bar hangers AHC ² - Adjustable hat channel bars NA - None	120V - 120V 277V - 277V UNV - 120V-277V

¹ See page 7 for more details.
² Not available with RM installation type.

LUMEN PACKAGE ³	DIMMING ⁴

S	890LM - 890 lm	INTEGRAL DRIVER	REMOTE DRIVER ⁹
M	2100LM - 2100 lm	D1 - 1% 0-10V ELV ^{5,6,7} - ELV 120V TRI ^{5,6,7} - TRIAC 120V LDE1 ⁸ - Lutron Hi-Lume 1% Eco DA ⁸ - DALI	RED1 - 1% 0-10V RELV ^{5,6,7} - ELV 120V RTRI ^{5,6,7} - TRIAC 120V RLDE1 ⁸ - Lutron Hi-Lume 1% Eco RDA ⁸ - DALI
L	2750LM - 2750 lm	ELDO - eldoLED 0.1% SOLOdrive 0-10V PEQ0 ^{7,8} - Lutron Hi-Lume Premier 0.1% EcoSystem	RELD1 - eldoLED 1% ECOdrive 0-10V RELD0 - eldoLED 0.1% SOLOdrive 0-10V RPEQ0 ^{7,8} - Lutron Hi-Lume Premier 0.1% EcoSystem

³ Delivered lumens at 90CRI, 3500K.

⁴ PoE (Power-over-Ethernet) compatible. Consult factory for details.
⁵ Available with 120V only.
⁶ Not available with Cluster Pi S.

⁷ Not available with Cluster Pi M.
⁸ On-site commissioning is required.
⁹ A remote driver box is provided, see page 5 for details.

2 - Light

LUMINAIRE ID	TRIM STYLE	LIGHT SOURCE	OPTIC	BEAM	CRI	COLOR TEMPERATURE
		SW	MRO		90CRI	
CLUPISRL - Cluster Pi S Recessed CLUPIMRL - Cluster Pi M Recessed CLUPIRL - Cluster Pi L Recessed	TRM - Flanged trim TLMP - Trimless drywall mudplate TLMW - Trimless millwork	SW - Static white	MRO - Miniature Reflector Optic	NFL - Narrow flood FLD - Flood WFL - Wide flood	90CRI - 90 CRI	27K - 2700K 30K - 3000K 35K - 3500K 40K - 4000K 50K - 5000K

TRIM FINISH	LOUVER	LOUVER FINISH	CENTER BLANK FINISH ¹⁰	ADD-ONS ^{11, 12}
	SQR			()

FTMW - Textured matte white FTMB - Textured matte black CF# - Custom finish, specify RAL#	SQR - Square	MF01 - Matte white MF04 - Matte black AM07 - Matte silver	FTMW - Textured matte white FTMB - Textured matte black CF# - Custom finish, specify RAL# NA - Not applicable ¹⁰ Specify NA if adding a Hemi or Ecana add-on.	M HEMSSA() - Hemi S soft ambient HEMS12() - Hemi S 2" adjustable module EC4A() - Ecana 4" adjustable module DOTCY() - Dot 1" Cylinder DOT2CY() - Dot 2" Cylinder ¹¹ Not available for Cluster Pi S. ¹² See pages 3 and 4 for ordering details.	L HEMLSA() - Hemi L soft ambient HEML12() - Hemi L 2" adjustable module HEML13() - Hemi L 3" adjustable module DOT1() - Dot 1" DOT2() - Dot 2" DOT1CY() - Dot 1" Cylinder DOT2CY() - Dot 2" Cylinder
---	--------------	---	--	--	--



CLUSTER PI

RECESSED

MRO OPTIC



Add-ons

For an add-on, specify the options in the parentheses.

CLUSTER PI M

HEMSSA() - Hemi S soft ambient

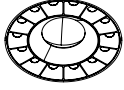

CLUSTER PI L

HEMLSA() - Hemi L soft ambient

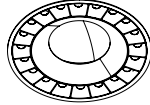

Example: HEMLSA(10W-90CRI-35K-TMW-TMW)

	WATTAGE	CRI	COLOR TEMPERATURE	BAFFLE FINISH	DOME FINISH
S	7W - 7 W output, up to 273 lm	90CRI - 90 CRI 95CRI - 95 CRI	27K - 2700K 30K - 3000K 35K - 3500K 40K - 4000K 50K - 5000K	FTMW - Textured matte white FTMB - Textured matte black CF# - Custom finish, specify RAL#	FTMW - Textured matte white FTMB - Textured matte black CF# - Custom finish, specify RAL#
L	10W - 10 W output, up to 413 lm	80CRI - 80 CRI			

CLUSTER PI M

HEMS12() - Hemi S 2" adjustable module

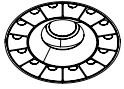

CLUSTER PI L

HEML12() - Hemi L 2" adjustable module

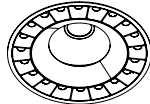

CLUSTER PI L

HEML13() - Hemi L 3" adjustable module

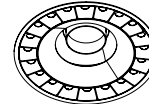

Example: HEMS12(10W-10DEG-2STP-90CRI-35K-LS-TMW-TMW-TMW)

	WATTAGE	BEAM	COLOR QUALITY	CRI	COLOR TEMP.	OPTICAL OPTION ¹	MODULE FINISH	BAFFLE FINISH	DOME FINISH
2"	10W - 10 W output, up to 1103 lm	10DEG - 10° Narrow spot 20DEG - 20° Spot 30DEG - 30° Narrow flood 40DEG - 40° Flood 50DEG - 50° Wide flood	2STP - 2 step MacAdam Ellipse 3STP - 3 step MacAdam Ellipse	90CRI - 90 CRI 95CRI - 95 CRI 80CRI - 80 CRI	27K - 2700K 30K - 3000K 35K - 3500K 40K - 4000K 50K - 5000K	LS - Linear spread HEX ² - Hex louver SNB - Snoot, black SNW - Snoot, white HSNB - Half snoot, black HSNW - Half snoot, white NA - None	FTMW - Textured matte white FTMB - Textured matte black CF# - Custom finish, specify RAL#		
3"	14W - 14 W output, up to 1532 lm								

¹Maximum 1 accessory for each module.
²Always in textured matte black.

CLUSTER PI M

EC4A() - Ecana 4" adjustable module

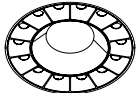

Example: EC4A(14W-50DEG-2STP-90CRI-35K-LS-CL-TMB)

	WATTAGE	BEAM	COLOR QUALITY	CRI	COLOR TEMP.	ACCESSORIES	LENS	BAFFLE FINISH
	14W		2STP					
	14W - 14 W output, up to 1348 lm	15DEG - 15° Narrow spot 25DEG - 25° Spot 35DEG - 35° Narrow flood 50DEG - 50° Wide flood 80DEG - 80° Very wide flood 90DEG - 90° Open flood	2STP - 2 step MacAdam Ellipse	90CRI - 90 CRI 95CRI - 95 CRI 80CRI - 80 CRI	27K - 2700K 30K - 3000K 35K - 3500K 40K - 4000K 50K - 5000K	At light element ^{1,2} (choose up to 2 options) LSDL - Soft diffused lens, Solite LFDL - Frosted diffused lens LS - Linear spread NA - None	At baffle (choose 1 option) SDL - Soft diffused lens, Solite FDL - Frosted diffused lens CL - Clear lens NOL - No lens	FTMW - Textured matte white FTMB - Textured matte black CF# - Custom finish, specify RAL#

¹Separate codes with a "*" if more than one is specified, e.g. LSDL*LS.
²LSDL and LFDL cannot be combined.

[ORDER GUIDE](#) | [ADD-ONS](#) | [OVERVIEW](#) | [HOUSING](#) | [LIGHT](#) | [PHOTOMETRICS](#) | [TECHNICAL SPECIFICATIONS](#)

www.lumenwerx.com
T (514) 225-4304

© Lumenwerx, ULC. All rights reserved.



Lumenwerx reserves the right to modify product specifications without notification.

CLUSTER-PI-RECESSED-MRO-SPEC-REV1 January 24, 2024



CLUSTER PI

RECESSED

MRO OPTIC



CLUSTER PI L

DOT1() - Dot 1"

DOT2() - Dot 2"

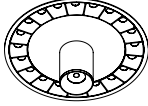
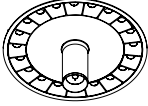

Example: DOT1(2.65IN-SPT-90CRI-900LM-35K-TMW-SDB-TMW)

HEIGHT	BEAM ANGLE	CRI	LUMEN PACKAGE	COLOR TEMP.	CYLINDER FINISH	BAFFLE	BAFFLE FINISH
2.65IN - 2.65" 4IN - 4"	SPT - Spot, 20° FLD - Flood, 35° WFL - Wide flood, 50°	90CRI - 90 CRI 95CRI - 95 CRI 80CRI - 80 CRI	1" 2.65" 900LM - 900 lm, 12.2 W	27K - 2700K 30K - 3000K 35K - 3500K 40K - 4000K 50K - 5000K	FTMW - Textured matte white FTMB - Textured matte black CF# - Custom finish, specify RAL#	SDB - Standard baffle DCB - Decorative baffle	FTMW - Textured matte white FTMB - Textured matte black CF# - Custom finish, specify RAL#
			1" 4" 1120LM - 1120 lm, 15.9 W				
			2" 2.65" 1100LM - 1100 lm, 15.9 W				
			2" 4" 1260LM - 1260 lm, 17.8 W				

CLUSTER PI M & L

DOT1CY() - Dot 1" Cylinder

DOT2CY() - Dot 2" Cylinder

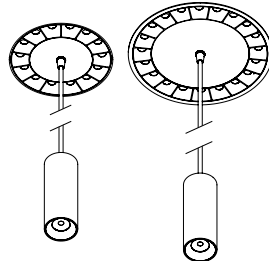
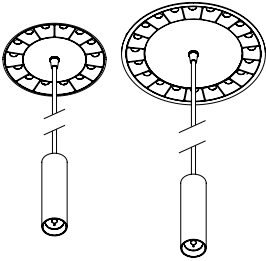

Example: DOT1CY(6IN-SPT-90CRI-900LM-35K-TMW-SDB-TMW-WPC15IN)

HEIGHT	BEAM ANGLE	CRI	LUMEN PACKAGE	COLOR TEMP.	CYLINDER FINISH	BAFFLE	BAFFLE FINISH	SUSPENSION ¹
6IN - 6" 9IN - 9" 12IN - 12" 18IN - 18"	SPT - Spot, 20° FLD - Flood, 35° WFL - Wide flood, 50°	90CRI - 90 CRI 95CRI - 95 CRI 80CRI - 80 CRI	1" 900LM - 900 lm, 12.2 W	27K - 2700K 30K - 3000K 35K - 3500K 40K - 4000K 50K - 5000K	FTMW - Textured matte white FTMB - Textured matte black CF# - Custom finish, specify RAL#	SDB - Standard baffle DCB - Decorative baffle	FTMW - Textured matte white FTMB - Textured matte black CF# - Custom finish, specify RAL#	BPC##IN - Black PVC WPC##IN - White PVC ¹ Min 12" - max 72", specify length (##) in inches.
			1" 1120LM - 1120 lm, 15.9 W					
			2" 1100LM - 1100 lm, 15.9 W					
			2" 1260LM - 1260 lm, 17.8 W					

CLUSTER PI

RECESSED

MRO OPTIC



Overview

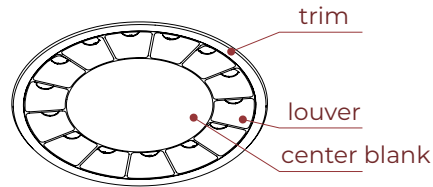

Housing

INSTALLATION TYPE

	OF - Open frame		RM - Remodel	
CLUSTER PI S	1 driver		1 driver	
CLUSTER PI M	1 driver	2 drivers	1 driver	2 drivers
CLUSTER PI L	1 driver	2 drivers		

REMOTE DRIVER BOX

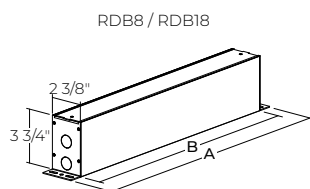

	RDB8	RDB18
A	10"	20"
B	8"	18"
DRIVER	RD1 - 1% 0-10V RELV - ELV 120V RTRI - TRIAC 120V RPEQO - Lutron Hi-Lume Premier 0.1% EcoSystem	RLDE1 - Lutron Hi-Lume 1% Eco RDA - DALI RELD1 - eldoLED 1% ECOdrive 0-10V RELDO - eldoLED 0.1% SOLOdrive 0-10V

[ORDER GUIDE](#) | [ADD-ONS](#) | [OVERVIEW](#) | [HOUSING](#) | [LIGHT](#) | [PHOTOMETRICS](#) | [TECHNICAL SPECIFICATIONS](#)



CLUSTER PI

RECESSED

MRO OPTIC



CEILING DETAILS

CLUSTER PI S

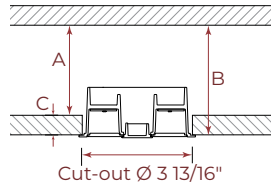

TRM - Flanged trim
TLMP - Trimless drywall mudplate

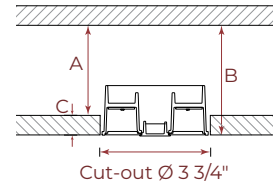

TLMW - Trimless millwork

CLUSTER PI M

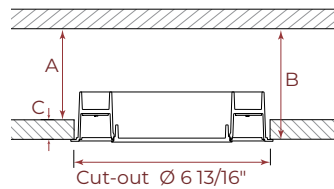

TRM - Flanged trim
TLMP - Trimless drywall mudplate

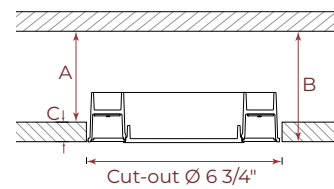

TLMW - Trimless millwork

CLUSTER PI L

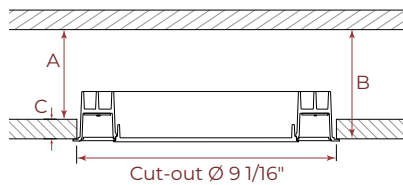

TRM - Flanged trim
TLMP - Trimless drywall mudplate

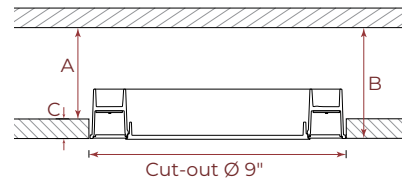

TLMW - Trimless millwork

PLENUM CLEARANCE HEIGHT DIMENSIONS			C MAXIMUM CEILING THICKNESS
A OPEN FRAME REMOTE & INTEGRAL	B REMODEL INTEGRAL	B REMODEL REMOTE	
S	4 1/4" (3 3/4" for FMB)	7 1/2"	11/8"
M	4 1/4" (3 3/4" for FMB)	3 3/4"	11/8"
L	4 1/4" (3 3/4" for FMB)	3 3/4"	11/8"

CLUSTER PI

RECESSED

MRO OPTIC



MOUNTING OPTIONS

ASB - Adjustable Standard Bar Hangers

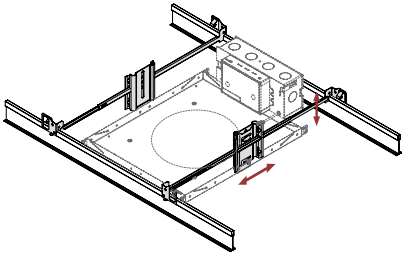

Adjustable Standard Bar hangers can be used in both commercial and residential applications and are adjustable to various heights in both Grid Ceiling and Drywall mounting. ASB hangers are less rigid and versatile than ACB hangers.

FMB - Flush Mount Bars

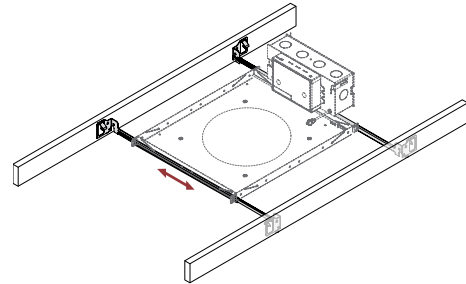

Flush Mount Bars are best used in residential applications, fitting snug to the surface and suitable for Wood, Metal, and Drywall mounting. The flush mounted bars are static and can't be adjusted.

ACB - Adjustable Commercial Bar Hangers

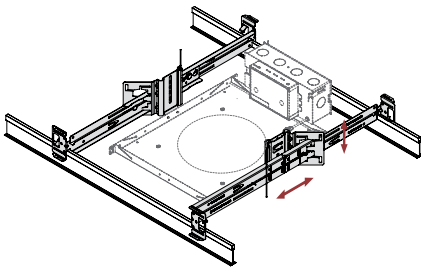

Adjustable Commercial Bar hangers can be used in both commercial and residential applications and are by far the most versatile mounting bar we offer with its adjustability to various heights. ACB hangers are suitable for Grid Ceiling, Drywall, Metal, Wood and Frame mounting.

- Extremely rigid
- Fits into C-Channel notches in a Butterfly Bracket

AHC - Adjustable Hat Channel Bars

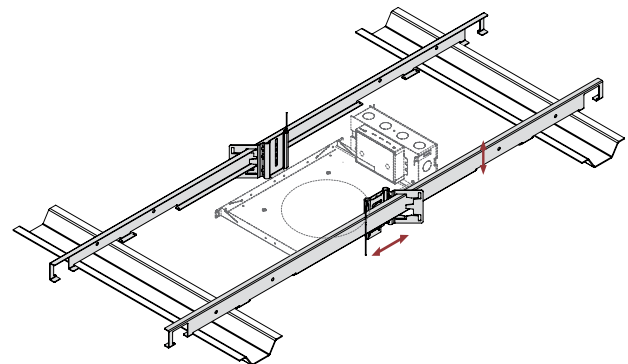

Adjustable Hat Channel bars can be used in both commercial and residential applications and come with a butterfly clip to adjust to various heights. AHC bars can be hung downward by 90 degrees in vertical position, and once wired, can be shifted onto the horizontal mounting plane. AHC bars are suitable for both Drywall and wood ceiling applications.

CLUSTER PI

RECESSED

MRO OPTIC



Light

CLUSTER PI S

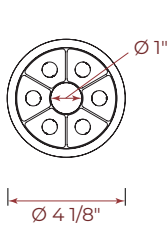

TRM - Flanged trim

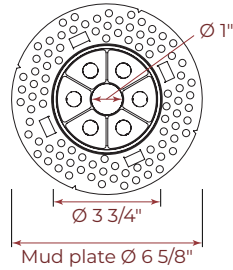

TLMP - Trimless drywall mudplate

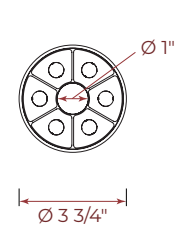

TLMW - Trimless millwork

CLUSTER PI M

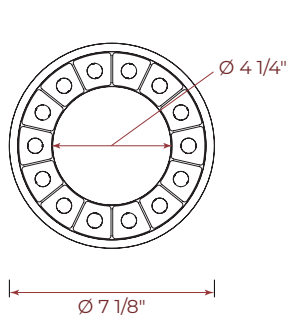

TRM - Flanged trim

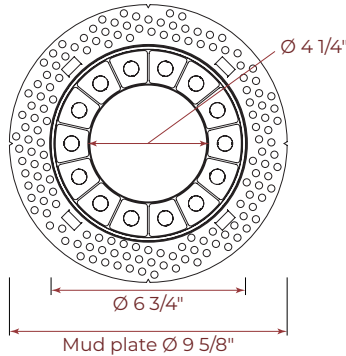

TLMP - Trimless drywall mudplate

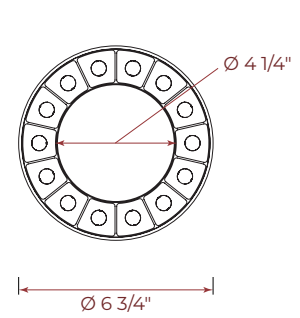

TLMW - Trimless millwork

CLUSTER PI L

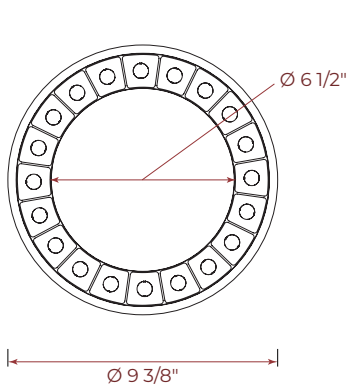

TRM - Flanged trim

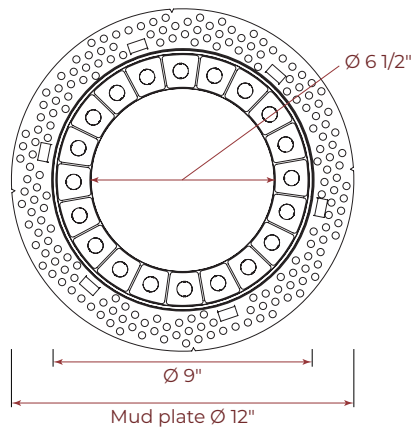

TLMP - Trimless drywall mudplate

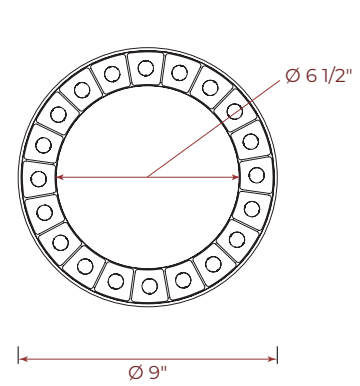

TLMW - Trimless millwork

[ORDER GUIDE](#) | [ADD-ONS](#) | [OVERVIEW](#) | [HOUSING](#) | [LIGHT](#) | [PHOTOMETRICS](#) | [TECHNICAL SPECIFICATIONS](#)

www.lumenwerx.com
T (514) 225-4304

© Lumenwerx, ULC. All rights reserved.



Lumenwerx reserves the right to modify product specifications without notification.
CLUSTER-PI-RECESSED-MRO-SPEC-REV1 January 24, 2024



CLUSTER PI

RECESSED

MRO OPTIC



Photometrics

Please follow the multiplier tables to ensure correct lumen value. Beams, CCT, dome colors, baffle colors, and accessories will change the lumen value.

MRO

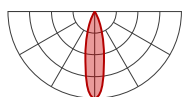

NFL - Narrow flood, 25°

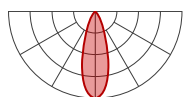

FLD - Flood, 35°

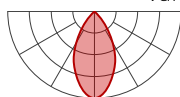

WFL - Wide flood, 55°

Values calculated based on 3500K and 90 CRI.

	LM	W	LM/W
S	890	15	59
M	2100	30.6	70
L	2750	44.6	62

MRO MULTIPLIERS

CCT	WATTS 90 CRI	LPW 90 CRI
2700K	1.15	0.87
3000K	1.08	0.93
3500K	1	1
4000K	0.97	1.03
5000K	0.93	1.08

HEMI- SOFT AMBIENT

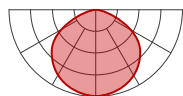

130°

Values calculated based on 3500K.

	90 CRI			95 CRI			80 CRI		
W	LM	LM/W	LM	LM/W	LM	LM/W	LM	LM/W	
7 W	232	33	243	35	273	39			
10 W	351	35	368	37	413	41			

HEMI - SOFT AMBIENT MULTIPLIERS

CCT	LPW
2700K	0.96
3000K	0.99
3500K	1
4000K	1.03
5000K	1.05

HEMI - ADJUSTABLE MODULE

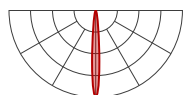

10°

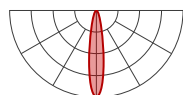

20°

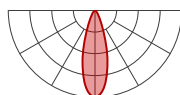

30°

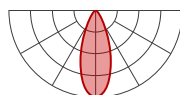

40°

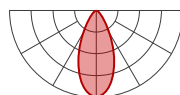

50°

HEMI 2"

Values calculated based on 3500K and white baffle.

CRI	90 CRI					95 CRI					80 CRI				
BEAM	10°	20°	30°	40°	50°	10°	20°	30°	40°	50°	10°	20°	30°	40°	50°
LM	641	630	1012	978	966	580	570	916	885	874	694	683	1103	1068	1057
LM/W	64	63	101	98	97	58	57	92	89	87	69	68	110	107	106

HEMI - ADJUSTABLE MODULE MULTIPLIERS

CCT	LPW
2700K	0.94
3000K	0.96
3500K	1
4000K	1.02
5000K	1.03

HEMI 3"

Values calculated based on 3500K and white baffle.

CRI	90 CRI					95 CRI					80 CRI				
BEAM	10°	20°	30°	40°	50°	10°	20°	30°	40°	50°	10°	20°	30°	40°	50°
LM	1257	1203	1410	1424	1379	1137	1108	1277	1289	1248	1348	1294	1501	1532	1475
LM/W	90	86	101	102	99	81	79	91	92	89	96	92	107	109	105

OPTICAL OPTIONS	
Linear spread	0.84
Hex louver	0.86
Snoot	Variable per beam
Half snoot	Variable per beam

CLUSTER PI

RECESSED

MRO OPTIC



ECANA 4" ADJUSTABLE MODULE

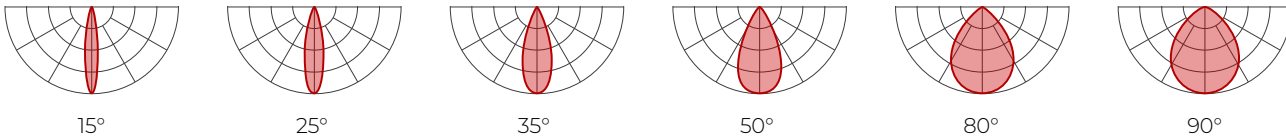

Values calculated based on 3500K, bevel baffle, and SDL lens option.

CRI	90 CRI						95 CRI						80 CRI					
	15°	25°	35°	50°	80°	90°	15°	25°	35°	50°	80°	90°	15°	25°	35°	50°	80°	90°
LM	1226	1260	1213	1189	1070	1070	944	970	934	916	824	824	1312	1348	1298	1272	1145	1145
LM/W	88	90	87	85	76	76	67	69	67	65	59	59	94	96	93	91	82	82

ECANA 4" ADJUSTABLE MODULE

MULTIPLIERS

CCT		LENS AND ACCESSORIES	
2700K	0.94	No lens	1.1
3000K	0.96	Soft diffused lens, Solite	1
3500K	1	Frosted lens	0.8
4000K	1.02	Clear lens	1.1
5000K	1.03	Linear spread	0.84

DOT

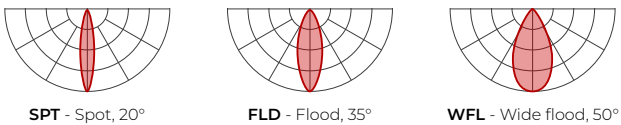

DOT CYLINDER

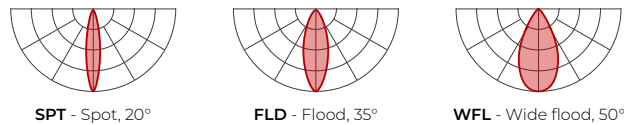

Values calculated based on 3500K and 80 CRI.

SIZE	HEIGHT	LM	W
1IN	2.65"	900	12.2
	4"	1120	15.9
2IN	2.65"	1100	15.9
	4"	1260	17.8

Values calculated based on 3500K and 80 CRI.

SIZE	LM	W
1IN	900	12.2
	1120	15.9
2IN	1100	15.9
	1260	17.8

DOT / DOT CYLINDER

MULTIPLIERS

CCT	LUMENS		
	80 CRI	90 CRI	95 CRI
2700K	0.94	0.77	0.72
3000K	0.96	0.82	0.75
3500K	1	0.85	0.81
4000K	1.02	0.87	0.79
5000K	1.03	0.87	0.76

CLUSTER PI

RECESSED

MRO OPTIC



Technical Specifications

OPTIC

Miniature Reflector Optic (MRO)

The Miniature Reflector Optic (MRO) is composed of molded Total Internal Reflection (TIR) elements placed over the LED emitter, along with precise parabolic reflectors that further shield the light source. The resulting beam is soft with a feathered edge.

LIGHT SOURCE

Compact COB (Chip-On-Board) LED module, available in 2700K, 3000K, 3500K, 4000K, and 5000K with 90 CRI and elevated R9 value. Color consistency maintained to within 3 SDCM. All LEDs have been tested in accordance with IESNA LM-80-08 and the results have shown L80 lumen maintenance greater than 60,000 hours. Absolute product photometry is measured and presented in accordance with IESNA LM-79, unless otherwise indicated.

ELECTRICAL

Unless otherwise specified, dimming down to 1%. At maximum driver load: efficiency > 84%, PF > 0.9, THD < 20%.

Integral driver: 0-10V, ELV, TRIAC, Lutron Hi-Lume EcoSystem, DALI, eldoLED 0.1% SOLOdrive 0-10V, eldoLED 1% ECOdrive 0-10V

Remote driver: 0-10V, ELV, TRIAC, Lutron Hi-Lume EcoSystem, DALI, eldoLED 0.1% SOLOdrive 0-10V, eldoLED 1% ECOdrive 0-10V

PoE

Depending on the PoE manufacturer selected, Lumenwerx will install the node in factory as either integral to the luminaire or as a remote module. Factory programming of the PoE node may or may not enable the following functionalities: lumen package, DUO (tunable white), QUADRO (RGBW), emergency battery backup, and sensor integration. These must be addressed and evaluated on a case-by-case basis.

CONSTRUCTION

Housing: Die-cast aluminum

MRO lens: Polycarbonate

Mounting frame: Galvanised steel

Finish: Textured matte white and matte black. Custom colors also available (provide RAL #).

WEIGHT

	<u>Open frame</u>	<u>Remodel</u>
Cluster Pi S	3 lbs - 1.3 kg	0.53 lbs - 0.24 kg
Cluster Pi M	4.3 lbs - 2 kg	1.25 lbs - 0.6 kg
Cluster Pi L	5 lbs - 2.25 kg	1.8 lbs - 0.8 kg

CERTIFICATION

ETL: Rated for indoor dry/damp locations. Conforms to UL Standard 1598 and certified to CAN/CSA Standard C22.2 No. 250.0.

WARRANTY

Lumenwerx provides a five-year limited warranty of electrical and mechanical performance of the luminaires, including the LED boards, drivers, and auxiliary electronics. Lumenwerx will repair or replace defective luminaires or components at our discretion, provided they have been installed and operated in accordance with our specifications. Other limitations apply, please refer to the full warranty on our website.

