

COMPASS DECO

RECESSED WALL



Designed for indoor wayfinding, Compass Deco fixtures integrate cleanly into architectural surfaces, providing clear, legible guidance across circulation spaces. Suitable for corridors, stairways, walkways, and transitional areas, Deco features a decorative faceplate and is available in round and square forms. Supporting both new construction and remodel applications, Deco can distribute direct or indirect light, delivering low-level illumination with high visual comfort.



Compass
Brochure



FOR INDOOR
APPLICATIONS

COMPASS DECO

RECESSED WALL



Project: _____

Type: _____

Order Guide

1 - Light & Housing

LUMINAIRE ID	FACEPLATE SHAPE ¹	FACEPLATE FINISH ²	LIGHT SOURCE ^{3,4}	WATTAGE		
CDEC			SW			
CDEC - Compass Deco	RO - Round SQ - Square ¹ See page 3 for more details.	FTMW - Matte white FTMB - Matte black WA - White antimicrobial Silverwerx CF# - Custom finish, specify RAL# ² See page 5 for more finish options.	SW - Static white ³ 90+ CRI. ⁴ For solid colors consult factory.		Round	Square
				2W	up to 62 lm	up to 82 lm
				3W	up to 69 lm	up to 92 lm

COLOR TEMPERATURE	VOLTAGE	MOUNTING	DRIVER	DIMMING
18K - 1800K 22K - 2200K 27K - 2700K 30K - 3000K 35K - 3500K 40K - 4000K 50K - 5000K	120V - 120V 277V - 277V UNV - 120V-277V	NCBB - New construction back box NCH - New construction housing with bar hangers RM - Remodel	INTEGRAL - Integral driver REMOTE - Remote driver	ND - No dimming DO NOT SPECIFY FOR REMOTE. SEE "REMOTE DRIVER BOX" SECTION BELOW

2. Remote Driver Box

Ordered separately. Specify each required remote driver box on a separate line.

REMOTE DRIVER ⁵	LUMINAIRE QUANTITY ⁶	LUMINAIRE ID	VOLTAGE	WATTAGE		DIMMING
RDB# - Remote driver box ⁵ Specify each required remote driver box on a separate line.	#X - Number of luminaires ⁶ Specify number (#) of luminaires per remote driver. Maximum is 20 fixtures per driver. See page 4 for details.	CDEC - Compass Deco	120V - 120V 277V - 277V UNV - 120V-277V		Round	Square
				2W	up to 62 lm	up to 82 lm
				3W	up to 69 lm	up to 92 lm
						RD1 - 1% 0-10V RDA ⁷ - DALI ⁷ On-site commissioning is required.

COMPASS DECO

RECESSED WALL



Dimensions

LIGHT

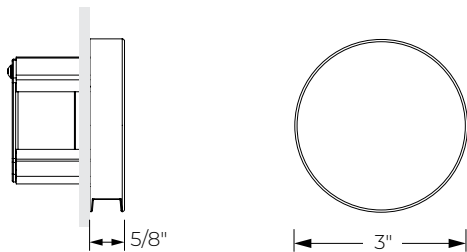

ROUND

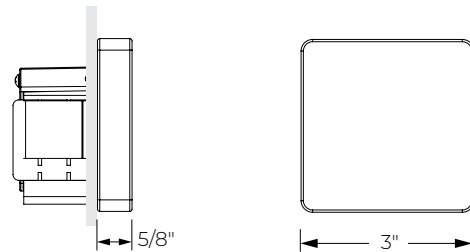

SQUARE

HOUSING

NCBB - New construction back box

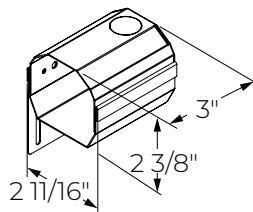

NCH - New construction housing with bar hangers

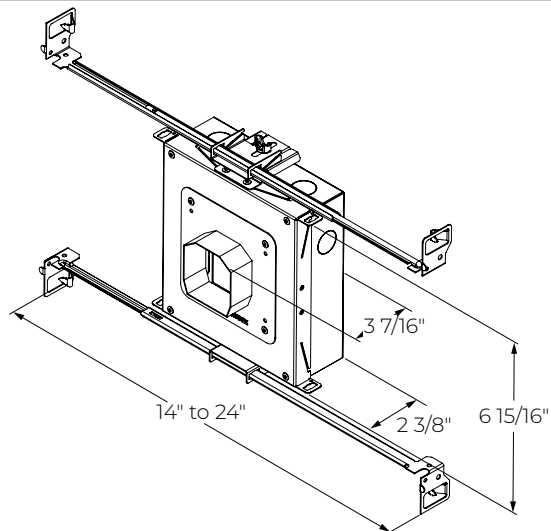

RM - Remodel

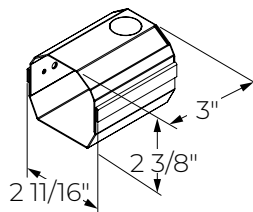

COMPASS DECO

RECESSED WALL



Spacing Recommendations

Recommended spacing dimensions for best uniform light distribution across the floor and to minimize shadows between fixtures.

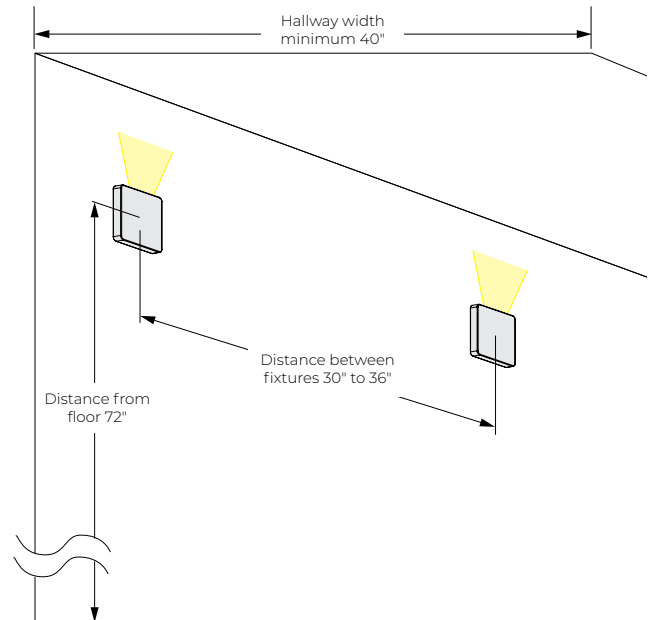
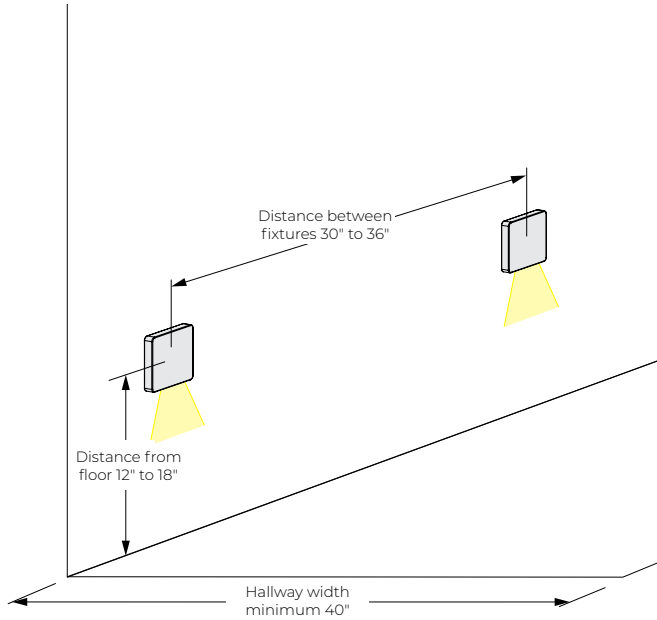

Dimensions not to scale, for visualization purposes only.

Remote Driver

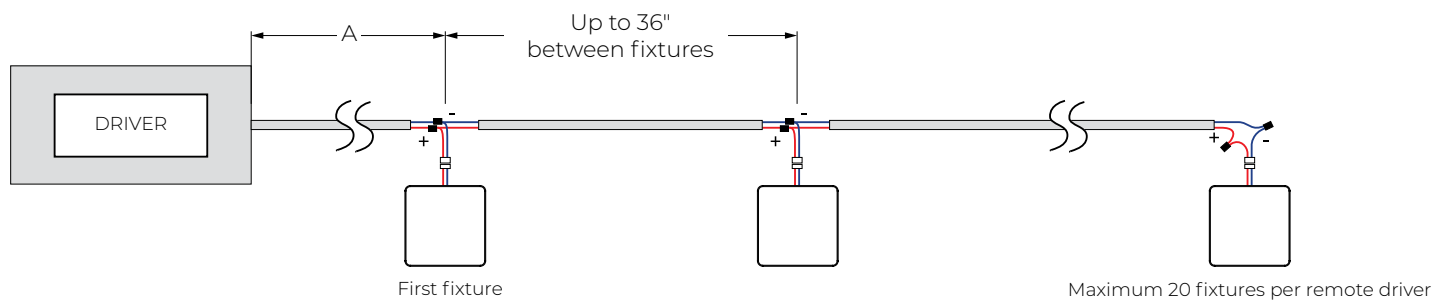

Remote driver box distance to first fixture *				
Wire AWG	12	14	16	18
A	150'	150'	125'	75'

* The distance from the remote driver box to the first fixture depends on the spacing between fixtures. These values are based on a distance of up to 36" between fixtures.

COMPASS DECO

RECESSED WALL



Finishes

Standard

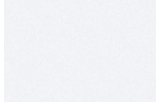

FTMW - Matte White



FTMB - Matte Black

Custom

Neutrals

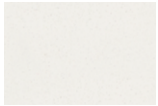

CRM - Cream



GRY - Gray



STG - Steel Gray



SAG - Sage Gray



BLB - Black Blue

Designer

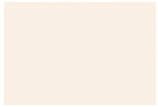

ALM - Almond

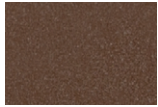

RST - Rust Fine
Texture



GRB - Green Beige



YLW - Yellow



SLM - Salmon Pink



VIO - Pastel Violet



RED - Red



PRR - Purple Red



SMB - Storm Blue



DPB - Deep Blue



OCB - Ocean Blue



BLG - Blue Green



GNS - Green Smoke



MNG - Mint Green

Metallics



CHP - Champagne

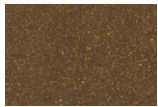

DBZ - Dark Bronze



CNY - Canyon

Premium Custom

Neutrals



MOG - Moss Gray



QRZ - Quartzite
Texture



LMG - Lime Green



GLD - Gold



IRN - Iron Ore

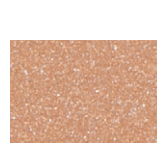

SBP - Sandblast
Copper



SWD - Sandalwood

COMPASS DECO

RECESSED WALL



Photometrics

Values calculated based on 3500K.

ROUND

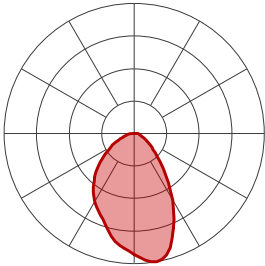

W	LM	LM/W
2 W	62	31
3 W	82	27

SQUARE

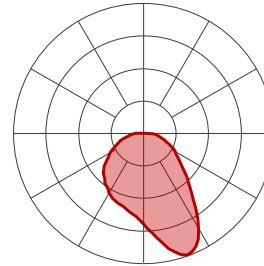

W	LM	LM/W
2 W	69	34.5
3 W	92	31

MULTIPLIER

Please follow the multiplier table to ensure correct lumen value. CCT will change the lumen value.

CCT	
1800K	0.84
2200K	0.93
2700K	0.98
3000K	1
3500K	1
4000K	1.03
5000K	1.03

Technical Specifications

LIGHT SOURCE

Custom array of mid-flux LEDs available in 1800K, 2200K, 2700K, 3000K, 3500K, 4000K, and 5000K with 90+ CRI with elevated R9 value. Color consistency is maintained to within 2 SDCM. All LEDs have been tested in accordance with IESNA LM-80-08 and the results have shown L80 lumen maintenance greater than 60,000 hours. Absolute product photometry is measured and presented in accordance with IESNA LM-79, unless otherwise indicated.

ELECTRICAL

Unless otherwise specified, dimming down to 1%. At maximum driver load: efficiency > 84%, PF > 0.9, THD < 20%.

Integral: No dimming

Remote: 0-10V, DALI

PoE

Depending on the PoE manufacturer selected, Lumenwerx will install the node in factory as either integral to the luminaire, or as a remote module. Factory programming of the PoE node may or may not enable the following functionalities: lumen package, DUO (tunable white), QUADRO (RGBW), emergency battery backup, and sensor integration. These must be addressed and evaluated on a case-by-case basis.

FINISH

Standard powder-coat paint available in matte white and black. Custom colors are also available. Optional antimicrobial finish.

CONSTRUCTION

Housing: Die-cast aluminum

Faceplate: Die-cast aluminum

Lens: Acrylic

Mounting frame: Galvanized sheet metal

Back box: Galvanized sheet metal

Remodel: Galvanized sheet metal

WEIGHT

Back box: 1.07 lbs - 0.49 kg

Mounting frame: 2.48 lbs - 1.12 kg

Remodel: 0.50 lbs - 0.23 kg

CERTIFICATIONS

ETL: Rated for indoor dry/damp locations. Conforms to UL Standard 1598 and certified to CAN/CSA Standard C22.2 No. 250.0.

IC rated: Suitable for direct contact with insulation

WARRANTY

Lumenwerx provides a five-year limited warranty on electrical and mechanical performance of the luminaires, including the LED boards, drivers, and auxiliary electronics. Lumenwerx will repair or replace defective luminaires or components at our discretion, provided they have been installed and operated in accordance with our specifications. Other limitations apply, please refer to the full warranty on our website.