

ECANA 3" DOWNLIGHT

SQUARE RECESSED



The Ecana downlight family is designed as round or square fixtures with simple detailing, available in 3", 4", and 6" sizes. The family includes fixed, adjustable, and wall wash configurations and blends effortlessly into various settings, enriching small and large-scale projects with practical, cost-effective, and finely tuned lighting.

Ceiling Types



Beam Angles

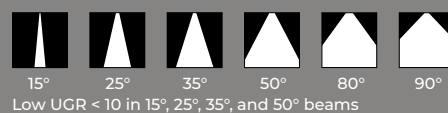

Plenum Clearance



Performance

LUMEN OUTPUT ¹	WATTS	EFFICACY
1132 lm	10 W	113 lm/W
1545 lm	14 W	110 lm/W
2135 lm	20 W	107 lm/W

¹Lumen packages are assuming 3500K, 80 CRI, 35° beam, with SDL lens option.

Certifications



Light Source

Static White
SOLA - Dim-to-Warm
DUO - Tunable White



Ecana Family (Refer to other spec sheets)



www.lumenwerx.com
T (514) 225-4304

© Lumenwerx, ULC. All rights reserved.



Lumenwerx reserves the right to modify product specifications without notification.

ECANA3-DOWNLIGHT-SQUARE-RECESSED-SPEC-REVO March 6, 2024



ECANA 3" DOWNLIGHT

SQUARE RECESSED



Project: _____

Type: _____

Order Guide

1 - Housing (Example: EC3SR-TRM-SW-OF-ASB-120V-10W-D1-NA)

LUMINAIRE ID ¹	TRIM STYLE	LIGHT SOURCE	INSTALLATION TYPE	MOUNTING OPTION ⁴
EC3SR				
EC3SR - Ecana 3" Square Recessed ¹ Recessed Adjustable and Recessed Wall Wash also available. Consult other spec sheets.	TRM - Flanged trim TLMP - Trimless drywall mudplate TLMW ² - Trimless millwork ² For remodel (RM) installation type, TLMW adapter must be installed from above the ceiling or before ceiling is installed.	SW - Static white SOLA - Dim-to-warm single channel control DUO - Tunable white 2-channel control	OF - Open Frame Type Non-IC IC ³ - Type-IC RM - Remodel Type Non-IC CP ³ - Chicago Plenum Type-IC (CCEA) AT ³ - Airtight Type-IC ³ Not available with 19 W output and higher.	ASB ⁵ - Adjustable standard bar hangers FMB ⁵ - Flush mount bars ACB ⁵ - Adjustable commercial bar hangers AHC ⁵ - Adjustable hat channel bars NA - None ⁴ See page 4 for more details. ⁵ Not available with RM installation type.
VOLTAGE	WATTAGE	DIMMING ⁹	OPTION	
120V - 120V 277V - 277V UNV - 120V-277V 347V ⁶ - 347V ⁶ Available with RD1 driver only. Please consult factory.	10W - 10 W output, up to 1132 lm 14W - 14 W output, up to 1545 lm 20W ^{7,8} - 20 W output, up to 2135 lm ⁷ Not available with 95 CRI when specified with RM. ⁸ Not available with IC/CP/AT. SOLA ⁸ 19W - 19 W output, up to 1205 lm DUO ⁸ 19W - 19 W output, up to 1355 lm	INTEGRAL D1 - 1% 0-10V ELV ¹⁰ - ELV 120V TRI ¹⁰ - TRIAC 120V DA ^{11,12} - DALI ELD1 ¹¹ - eldoLED 1% ECOdrive 0-10V ELDO ¹¹ - eldoLED 0.1% SOLOdrive 0-10V PEQO ^{12,13} - Lutron Hi-lume Premier 0.1% EcoSystem ⁹ PoE (Power-over-Ethernet) compatible. Consult factory for details. ¹⁰ Available with 120V only. ¹¹ Not available with RM installation type. ¹² On-site commissioning is required. ¹³ Available with OF installation type only.	REMOTE ¹⁴ RD1 - 1% 0-10V RELV ¹⁵ - ELV 120V RTRI ¹⁵ - TRIAC 120V RLDE1 ¹⁶ - Lutron Hi-lume 1% Eco RDA ¹⁶ - DALI RELD1 - eldoLED 1% ECOdrive 0-10V RELD0 - eldoLED 0.1% SOLOdrive 0-10V RPEQO ¹⁶ - Lutron Hi-lume Premier 0.1% EcoSystem +EB ¹⁷ - Emergency battery ¹⁴ A remote driver box is provided, see page 3 for details. ¹⁵ Available with 120V only. ¹⁶ On-site commissioning is required. ¹⁷ For emergency battery, code will be like the following example: RD1+EB	PMP ¹⁸ - Pre-mounting plate NA - None ¹⁸ Available with RM installation type only.
		SOLA SD1 - Single 0-10V input SELV ¹⁰ - ELV 120V STRI ¹⁰ - TRIAC 120V	SOLA RSD1 - Single 0-10V input RSELV ¹⁵ - ELV 120V RSTRI ¹⁵ - TRIAC 120V	DUO RDMX ¹⁶ - DMX RDDA ¹⁶ - DALI DT6 RDDA8 ¹⁶ - DALI DT8 RDD1 ¹⁵ - Dual 0-10V input for CCT/intensity RPSQO ¹⁶ - Lutron T-Series 1% tunable white

2 - Light & Baffle (Example: EC3SRB-SW-10W-15DEG-2STP-90CRI-27K-LSDL+LS-TRM-CL-FTMW-FTMW-NA)

LUMINAIRE ID	LIGHT SOURCE Specify same as Housing	WATTAGE Specify same as Housing	BEAM	COLOR QUALITY	CRI	COLOR TEMP.
EC3SRB						
EC3SRB - Ecana 3" Square Recessed	SW - Static white	10W - 10 W output, up to 1132 lm 14W - 14 W output, up to 1545 lm 20W ^{19,20} - 20 W output, up to 2135 lm ¹⁹ Not available with 95 CRI when specified with RM. ²⁰ Not available with IC/CP/AT.	15DEG - 15° Narrow spot 25DEG - 25° Spot 35DEG - 35° Narrow flood 50DEG - 50° Wide flood 80DEG - 80° Very wide flood 90DEG - 90° Open flood	2STP - 2 Step MacAdam Ellipse 3STP - 3 Step MacAdam Ellipse	90CRI - 90 CRI 95CRI - 95 CRI 80CRI - 80 CRI	27K - 2700K 30K - 3000K 35K - 3500K 40K - 4000K
	SOLA - Dim-to-warm single channel control DUO - Tunable white 2-channel control	SOLA ²⁰ 19W - 19 W output, up to 1205 lm DUO ²⁰ 19W - 19 W output, up to 1355 lm	25DEG - 25° Spot 35DEG - 35° Narrow flood 60DEG - 60° Wide flood 80DEG - 80° Very wide flood 90DEG - 90° Open flood	3STP - 3 Step MacAdam Ellipse	90CRI - 90 CRI	SOLA 30K18K - 3000K to 1800K 27K18K - 2700K to 1800K DUO 65K27K - 6500K to 2700K 50K27K - 5000K to 2700K

ACCESSORIES * See page 5 for details	TRIM STYLE Specify same as Housing	LENS * See page 5 for details	BAFFLE FINISH	TRIM FLANGE FINISH Specify NA for Trimless	OPTION
At light element ^{21,22} (choose up to 2 options for SW and 1 option for SOLA/DUO) LSDL - Soft diffused lens, Solite LFDL - Frosted diffused lens LS - Linear spread HEX ²³ - Hex louver NA - None ²¹ If two options are specified, separate codes with a "+", e.g. LSDL+LS. ²² LSDL and LFDL cannot be combined. LS and HEX cannot be combined. ²³ Not available with 80°/90° beam options.	TRM - Flanged trim TLMP - Trimless drywall mudplate TLMW ²⁴ - Trimless millwork ²⁴ For remodel (RM) installation type, TLMW adapter must be installed from above the ceiling or before ceiling is installed.	At baffle (choose 1 option) SDL - Soft diffused lens, Solite FDL - Frosted diffused lens CL - Clear lens NOL - No lens	FTMW - Textured matte white FTMB - Textured matte black CF# - Custom finish, specify RAL# CF# - Custom finish, specify RAL#	FTMW - Textured matte white FTMB - Textured matte black CF# - Custom finish, specify RAL# NA - Not applicable	WET ²⁵ - Wet location NA - None ²⁵ Must be specified with the flanged trim (TRM), and either SDL, FDL, or CL lens options.

* LSDL or LFDL at light element cannot be combined with SDL or FDL at baffle.



ECANA 3" DOWNLIGHT

SQUARE RECESSED



Housing

INSTALLATION TYPES		
OF - Open Frame Type Non-IC 	IC - Type-IC 	CP - Chicago Plenum Type-IC (CCEA) AT - Airtight Type-IC
RM - Remodel Type Non-IC		
Integral 	Remote 	PMP (Optional) - Pre-mounting plate

- For height dimension C, see the PLENUM CLEARANCE & CUT-OUT DIMENSIONS table below.
 - For OF, IC, CP, and AT installation types with remote dimming, a remote driver box is provided.

REMOTE DRIVER BOX

RDB8 / RDB18 / RDB24

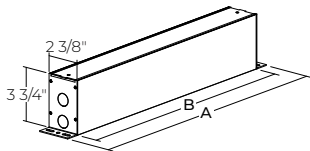

RDB24W

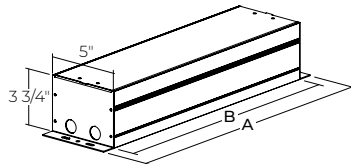

	RDB8	RDB18	RDB24	RDB24W
A	10"	20"	26"	26"
B	8"	18"	24"	24"
DRIVER	RD1 - 1% 0-10V RELV - ELV 120V RTRI - TRIAC 120V RPEQ0 - Lutron Hi-lume Premier 0.1% EcoSystem SOLA RSD1 - Single 0-10V input RSELV - ELV 120V RSTRI - TRIAC 120V	RLDE1 - Lutron Hi-lume 1% Eco RDA - DALI RELD1 - eldoLED 1% ECOdrive 0-10V RELD0 - eldoLED 0.1% SOLOdrive 0-10V	Emergency battery (+EB) with the following driver options. RD1+EB - 1% 0-10V RELV+EB - ELV 120V RTRI+EB - TRIAC 120V RPEQ0+EB - Lutron Hi-lume Premier 0.1% EcoSystem DUO RDMX - DMX RDDA - DALI DT6 RDDA8 - DALI DT8 RDD1 - Dual 0-10V input for CCT/intensity RPSQ0 - Lutron T-Series 1% tunable white	Emergency battery (+EB) with the following driver options. RLDE1+EB - Lutron Hi-lume 1% Eco RDA+EB - DALI RELD1+EB - eldoLED 1% ECOdrive 0-10V RELD0+EB - eldoLED 0.1% SOLOdrive 0-10V

PLENUM CLEARANCE & CUT-OUT DIMENSIONS

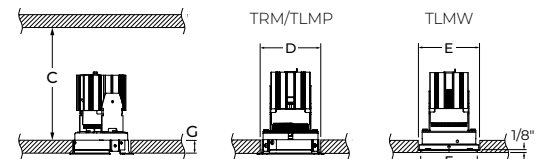

PLENUM CLEARANCE HEIGHT		
REMOTE & INTEGRAL		
C	OF	4" (10 W/14 W) 4 1/2" (20 W)
	IC	6 1/2"
	CP/AT	7"
	RM	4" (10 W/14 W) 4 1/2" (20 W)
CUT-OUT DIMENSIONS		
D	TRM/ TLMP	3 1/2" x 3 1/2"
E	TLMW	3 1/2" x 3 1/2"
F		3 1/16" x 3 1/16" with 1/8" lip
MAXIMUM CEILING THICKNESS		
G	TRM/ TLMP	1 3/8"
	TLMW	5/8"

ECANA 3" DOWNLIGHT

SQUARE RECESSED



Housing

MOUNTING OPTIONS

ASB - Adjustable Standard Bar Hangers

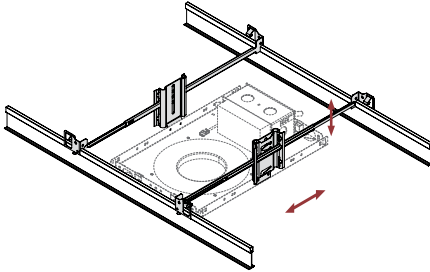

Adjustable Standard Bar hangers can be used in both commercial and residential applications and are adjustable to various heights in both Grid Ceiling and Drywall mounting. ASB hangers are less rigid and versatile than ACB hangers.

FMB - Flush Mount Bars

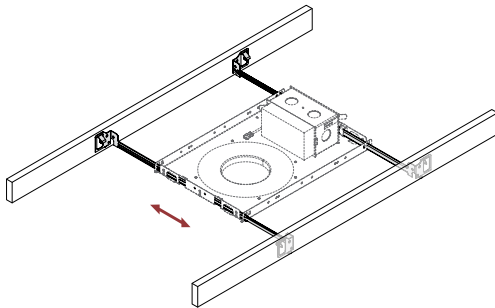

Flush Mount Bars are best used in residential applications, fitting snug to the surface and suitable for Wood, Metal, and Drywall mounting. The flush mounted bars are static and can't be adjusted.

ACB - Adjustable Commercial Bar Hangers

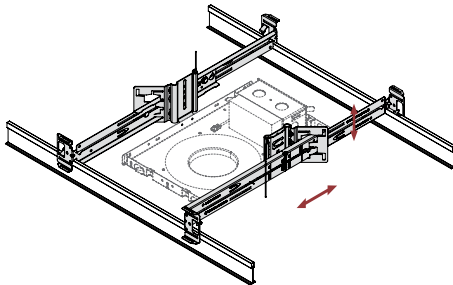

Adjustable Commercial Bar hangers can be used in both commercial and residential applications and are by far the most versatile mounting bar we offer with its adjustability to various heights. ACB hangers are suitable for Grid Ceiling, Drywall, Metal, Wood and Frame mounting.

- Extremely rigid
- Fits into C-Channel notches in a Butterfly Bracket

AHC - Adjustable Hat Channel Bars

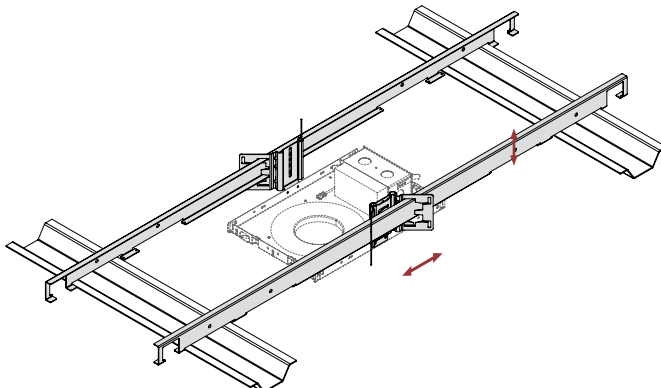

Adjustable Hat Channel bars can be used in both commercial and residential applications and come with a butterfly clip to adjust to various heights. AHC bars can be hung downward by 90 degrees in vertical position, and once wired, can be shifted onto the horizontal mounting plane. AHC bars are suitable for both Drywall and wood ceiling applications.

ECANA 3" DOWNLIGHT

SQUARE RECESSED



Light & Baffle

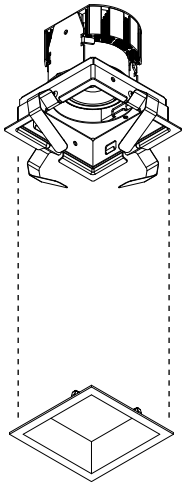

Flanged
Trim

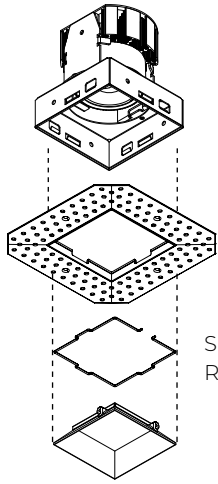

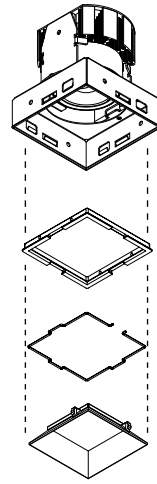

Trimless
Drywall
Mudplate

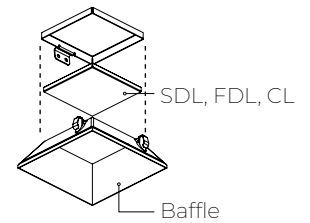
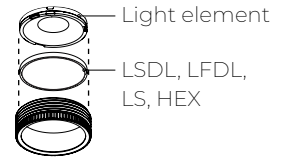

Trimless
Millwork

LENS AND ACCESSORIES

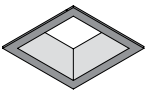
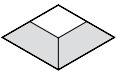

TRM Flanged Trim	TLMP/TLMW Trimless Drywall Mudplate /Trimless Millwork
	
<p> Baffle finish</p> <p> Trim flange finish</p>	

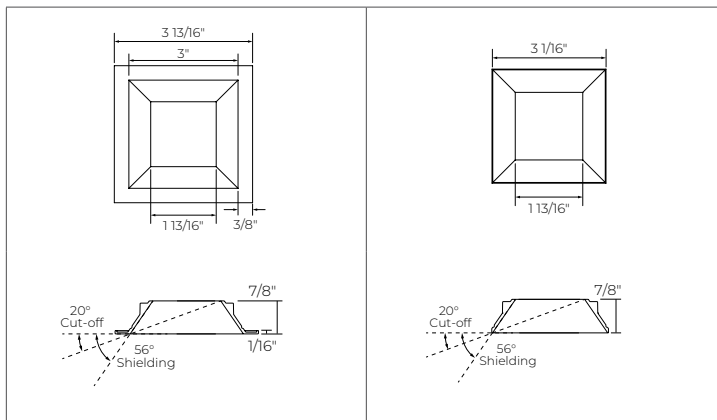

ECANA 3" DOWNLIGHT

SQUARE RECESSED



Color Quality

COLOR QUALITY - 3500K	
TM-30 R _t	92
TM-30 R _g	100
CRI	90
R9	> 50

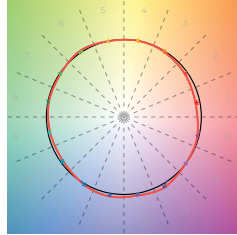

Photometrics

STATIC WHITE

Values calculated based on 3500K, bevel baffle, and SDL lens option.

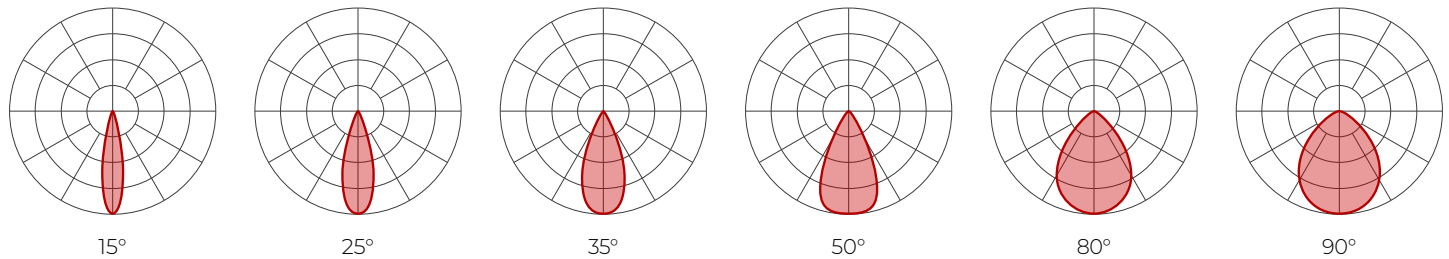

Delivered lumens

CRI	90 CRI						95 CRI						80 CRI					
	15°	25°	35°	50°	80°	90°	15°	25°	35°	50°	80°	90°	15°	25°	35°	50°	80°	90°
10 W	987	1053	1058	937	843	843	760	811	815	721	649	649	1056	1127	1132	1003	902	902
14 W	1347	1438	1444	1280	1152	1152	1037	1107	1112	986	887	887	1441	1539	1545	1370	1233	1233
20 W	1861	1986	1995	1768	1591	1591	1433	1529	1536	1361	1225	1225	1991	2125	2135	1892	1703	1703

Efficacy

CRI	90 CRI						95 CRI						80 CRI					
	15°	25°	35°	50°	80°	90°	15°	25°	35°	50°	80°	90°	15°	25°	35°	50°	80°	90°
10 W	99	105	106	94	84	84	76	81	81	72	65	65	106	113	113	100	90	90
14 W	96	103	103	91	82	82	74	79	79	70	63	63	103	110	110	98	88	88
20 W	93	99	100	88	80	80	72	76	77	68	61	61	100	106	107	95	85	85

MULTIPLIERS

Please follow the multiplier tables to ensure correct lumen value. Beams, CCT, baffle colors, lensing and accessories will change the lumen value.

CCT	TRIM STYLE AND BAFFLE FINISH	LENS * (At baffle)	ACCESSORIES * (At light element)
2700K	Flanged trim	SDL - Soft diffused lens, Solite	LSDL - Soft diffused lens, Solite
3000K	Trimless	FDL - Frosted lens	LFDL - Frosted lens
3500K	White	CL - Clear lens	LS - Linear spread
4000K	Black	NOL - No lens	HEX - Hex louver

* When more than one lens or accessory is specified, multiply together the value of each lens and/or accessory.
e.g. NOL + LSDL + LS = 1.1 x 1 x 0.84 = 0.924



ECANA 3" DOWNLIGHT

SQUARE RECESSED



Photometrics

SOLA/DUO

Values calculated based on bevel baffle and SDL lens option.

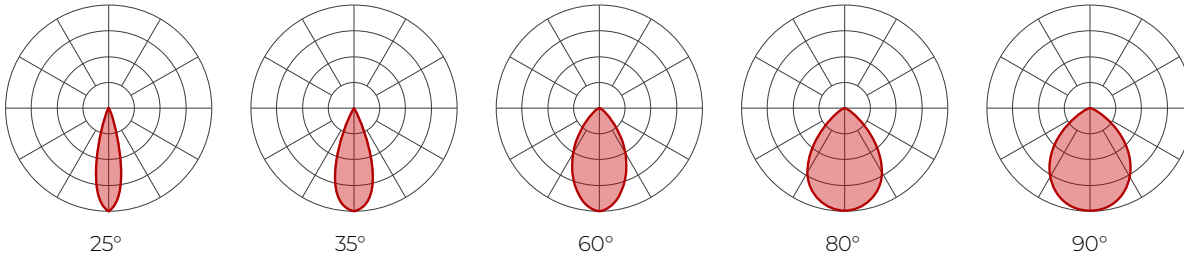

SOLA

BEAM		25°		35°		60°		80°		90°	
		lm	lm/W	lm	lm/W	lm	lm/W	lm	lm/W	lm	lm/W
19 W	3000K	1150	61	1205	63	1100	58	945	50	870	46
	2700K	1150	61	1205	63	1100	58	945	50	870	46

DUO

BEAM		25°		35°		60°		80°		90°	
		lm	lm/W	lm	lm/W	lm	lm/W	lm	lm/W	lm	lm/W
19 W	6500K	1285	68	1355	71	1190	63	1025	54	940	49
	5000K	1285	68	1355	71	1190	63	1025	54	940	49
	2700K	1050	55	1090	57	960	51	760	40	760	40

MULTIPLIERS

Please follow the multiplier tables to ensure correct lumen value. Beams, CCT, baffle colors, lensing and accessories will change the lumen value.

TRIM STYLE AND BAFFLE FINISH		LENS * (At baffle)		ACCESSORIES * (At light element)	
Flanged trim	1	SDL - Soft diffused lens, Solite	1	LSDL - Soft diffused lens, Solite	1
Trimless	1	FDL - Frosted lens	0.8	LFDL - Frosted lens	0.8
White	1	CL - Clear lens	1.1	LS - Linear spread	0.84
Black	1	NOL - No lens	1.1	HEX - Hex louver	0.86

* When more than one lens or accessory is specified, multiply together the value of each lens and/or accessory.
eg. NOL + LSDL = 1.1 x 1 = 1.1

ECANA 3" DOWNLIGHT

SQUARE RECESSED



Technical Specifications

OPTIC

XPoint™ Refraction Technology optics provide precise optical control in a remarkably compact form. Micro optical paths from the chip on board converge and then disperse in precise beam angles, resulting in a crisp and exacting light quality.

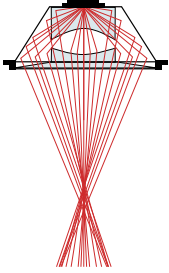

LIGHT SOURCE

Static white

Compact COB (Chip-On-Board) LED module, available in 2700K, 3000K, 3500K and 4000K with a choice of 80 CRI, 90 CRI, or 95 CRI, with elevated R9 value for 90 CRI and above. Color consistency is maintained to within 2 SDCM. All LEDs have been tested in accordance with IESNA LM-80-08 and the results have shown L80 lumen maintenance greater than 60,000 hours. Absolute product photometry is measured and presented in accordance with IESNA LM-79, unless otherwise indicated. Optional full spectrum LEDs can be incorporated in the fixture to increase Cyanosis Observation Index (COI) and assist in regulating circadian rhythms.

Chromawerx SOLA

Chromawerx SOLA is single-channel control that dims output while warming the color temperature in a pre-determined relationship. Two color temperature range options are offered: 3000K to 1800K, and 2700K to 1800K. A simple analog control adjusts a specially populated LED array to emulate the effect of dimming a filament source.

Chromawerx DUO

Chromawerx DUO offers a two-channel control system which uses analog or digital protocols for synchronous control of both cool to warm LED arrays - maintaining a CRI above 90. Two color temperature range options are offered: 6500K to 2700K, and 5000K to 2700K. The range of color DUO offers is useful for entraining circadian rhythms, stimulating alertness, and compensating for jet lag among other applications. The Chromawerx drivers are programmed to limit maximum light output and power usage across all color temperatures. When paired with DALI drivers (DDA/DDA8), color tuning follows a linear dimming curve.

ELECTRICAL

Unless otherwise specified, dimming down to 1%. At maximum driver load: efficiency>84%, PF>0.9, THD<20%.

Integral: 0-10V, ELV, TRIAC, Lutron Hi-Lume 1% EcoSystem, DALI, eldoLED 0.1% SOLOdrive 0-10V, eldoLED 1% ECOdrive 0-10V

Remote: 0-10V, ELV, TRIAC, Lutron Hi-Lume 1% EcoSystem, DALI, eldoLED 0.1% SOLOdrive 0-10V, eldoLED 1% ECOdrive 0-10V, DMX, Lutron T-series (tunable white)

Emergency battery options: Remotely-installed, long-life, high-temperature, maintenance-free, Bodine Lithium-Ion battery pack with self-test functionality, test switch and charge indicator. IOTA and Fulham options available upon request. Minimum of 90 minutes operation, and recharge time of 24 hours. For fixtures less than 10 W, the battery provides 6W of emergency light output. For fixtures 10 W and over, the battery provides 10 W.

PoE

Depending on the PoE manufacturer selected, Lumenwerx will install the node in factory as either integral to the luminaire or as a remote module. Factory programming of the PoE node may or may not enable the following functionalities: lumen package, DUO (tunable white), QUADRO (RGBW), emergency battery backup, and sensor integration. These must be addressed and evaluated on a case-by-case basis.

CONSTRUCTION

Housing

For new construction, 20 gauge powder coated steel. Open frame, type-IC, or Chicago Plenum (CCEA) rated. 18 gauge galvanized steel junction box with ½" trade size knockouts. Adjustable hanger bars and butterfly brackets are included. Adjustable commercial hat channel and flush mounted brackets are also available.

Light element

LED module: Integral COB module. 90 CRI and 2 SDCM, Standard with options of 80 CRI, or 95 CRI. L80 > 60,000 hours.

XPoint™ Refraction Technology optic: Micro optical paths from the chip on board converge and then disperse in precise beam angles, resulting in a crisp and exacting light quality.

Thermal management: Die-cast aluminum heat sink to maximize thermal dissipation.

Baffle: Die-cast aluminum mounted with retaining spring clips

Trim style: Trimmed and trimless with mudplate or millwork adapter

ECANA 3" DOWNLIGHT

SQUARE RECESSED



WEIGHT

Open frame: 4.3 lbs - 1.9 kg

Type-IC: 4.5 lbs - 2.0 kg

Chicago Plenum: 7.5 lbs - 3.4 kg

Remodel: 3.25 lbs - 1.5 kg

LENS AND ACCESSORIES



Soft diffused lens, Solite



Frosted diffused lens



Clear lens



Linear spread



Hex louver

ENVIRONMENT

Ambient temperature at fixture location shall be within 0°C/32°F - 25°C/77°F, indoor dry or damp as well as outdoor damp use (canopies or marquees).

CERTIFICATIONS

ETL: Rated for indoor dry/damp locations. Conforms to UL Standard 1598 and certified to CAN/CSA Standard C22.2 No. 250.0.

IP44: IP44 rated for bathrooms, showers, outdoor canopies, and marquees when specified with the wet location (WET) option.

Chicago Plenum: City of Chicago approved (CCEA) when specified with CP installation type option.

IC rated: Suitable for direct contact with insulation when specified with IC, CP or AT installation type options.

WARRANTY

Lumenwerx provides a five-year limited warranty on electrical and mechanical performance of the luminaires, including the LED boards, drivers, and auxiliary electronics. Lumenwerx will repair or replace defective luminaires or components at our discretion, provided they have been installed and operated in accordance with our specifications. Other limitations apply, please refer to the full warranty on our website.