

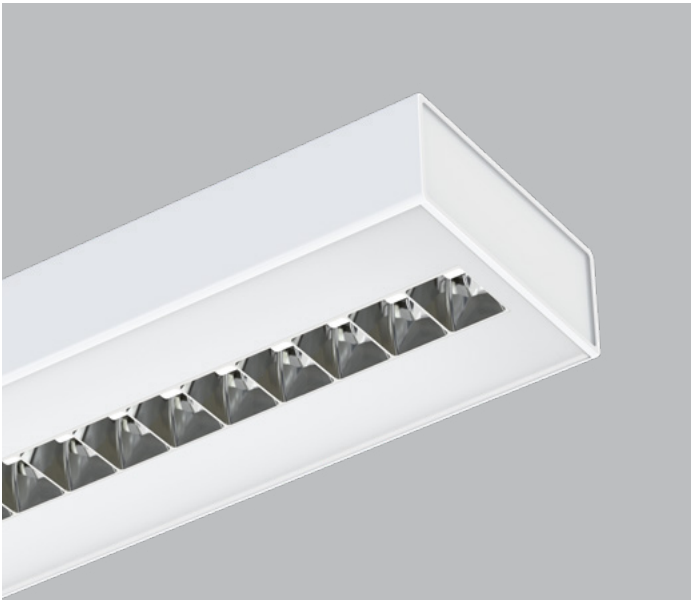

CHROMAWERX TUNABLE WHITE AND DIM TO WARM

DESCRIPTION

Within its compact 1 15/16" x 4 3/4" profile, Medius supports a choice of outstanding optics for high performance direct lighting. The result is excellent visual comfort with UGR better than 16, smooth ceiling uniformity, and efficacy up to 121 LPW. A new sliding cable arrangement simplifies installation in existing spaces. Medius configures as individual luminaires or continuous runs and features the full range of electrical and control options. For static white see separate specification sheet.



SPL - Specular parabolic louver

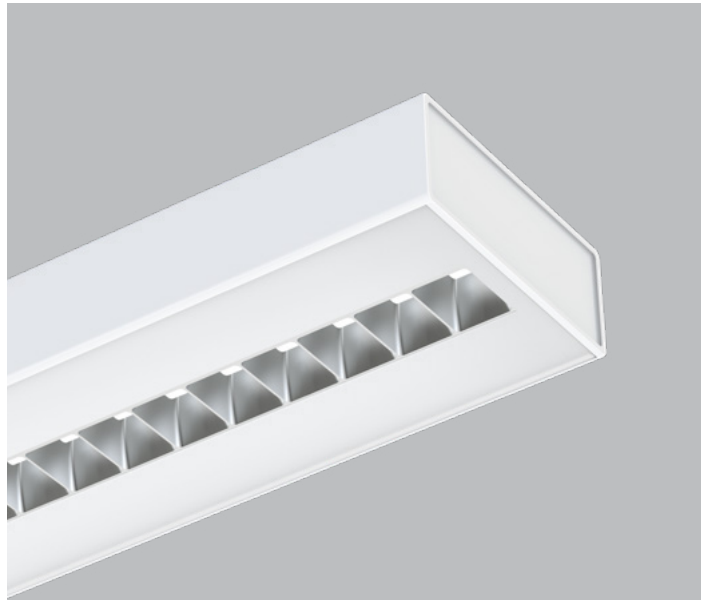

MPL - Matte parabolic louver

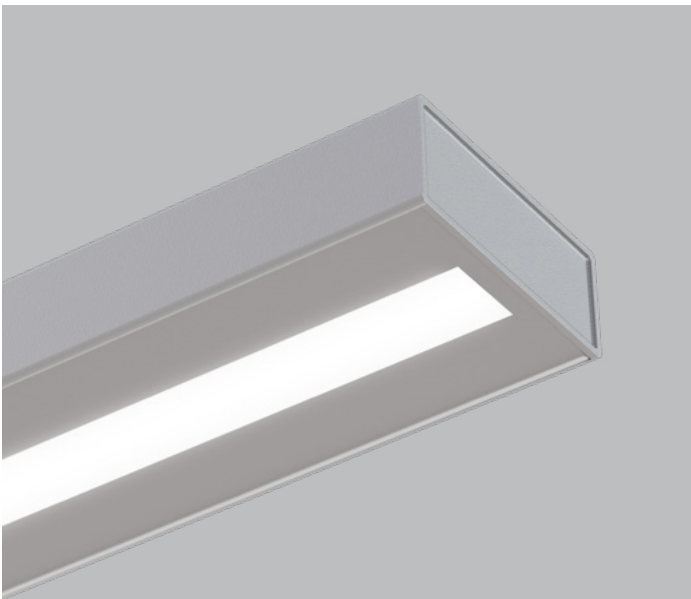

HLO - High-Efficiency Lambertian Optic

MEDIUS LED

PENDANT DIRECT



LUMENWERX
WWW.LUMENWERX.COM

CHROMAWERX TUNABLE WHITE AND DIM TO WARM

IMPORTANT: a qualified DMX integration consultant is required to ensure proper installation and function of any DMX network

PROJECT: _____
 TYPE: _____
 NOTES: _____

ORDER GUIDE

up to 121 lm/w performance

MEDD	LED			
LUMINAIRE ID	OPTICS	LIGHT SOURCE	CRI	LUMEN PACKAGES
MEDD - Medius pendant direct	SPL - Specular parabolic louver MPL - Matte parabolic louver HLO - High-Efficiency Lambertian Optic	LED - high performance LED	80 - 80CRI 90 - 90CRI	350 - min. eco low output 350lm/ft 500 - low output 500lm/ft 750 - medium output 750lm/ft 1000 - max. high output 1000lm/ft ##### - other required lm/ft

CHROMAWERX	LUMINAIRE LENGTH	VOLTAGE	DRIVER
DUO - tunable white 2 channel control 27k to 65k SOLA - dim to warm single channel control 22k to 35k	Available sections - 4', 8' & 12' #FT - nominal length in feet (2' increments only) Continuous Run - for luminaires over 12' Minimum Individual section 4'	120 - 120V 277 - 277V	DMX - to specify see pages 7 to 12 DA - Dali (duo only) local on-site commissioning is required O-10 - Single 0-10V input (Sola) or dual 0-10V input for CCT/Intensity (Duo) PSQO - Lutron T-Series 1% Tunable White

1	ELECTRICAL	MOUNTING	FINISH	OPTIONS
1 - 1 circuit		53WAC36 - Fixed cables suspension power 5" + non power 3" white canopy (36" air craft cable) SC53WAC36 - Sliding cables suspension , power 5" + non power 3" white canopy (36" air craft cable) 55WSW18 - power 5" + non power 5" white canopy & stem (18" stem) For all other options refer to our Pendant Mounting Guide	W - matte white AL - aluminum CF# - custom finish specify RAL#	FU - fuse TB# - T-bar caddy clip specify grid size TG# - Tegular caddy clip specify grid size ST - Screw Slots caddy clip CU - custom

DMX WALL CONTROLS

To specify see pages 7 to 12

See page 2 for ordering code detailed information

CROSS SECTION

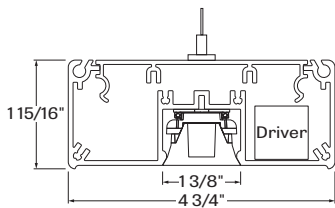

MEDD - SPL & MPL

Specular & Matte parabolic louver

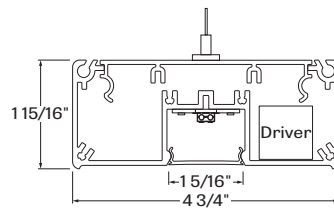

MEDD - HLO

High Efficiency Lambertian Optic



ANSI C78.377-2015

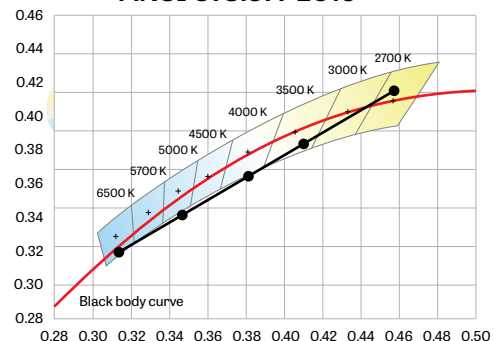

CHROMAWERX TUNABLE WHITE AND DIM TO WARM

DIRECT OPTICS

Parabolic Louvers (SPL and MPL)

Parabolic louvers provide excellent shielding and a pleasing crisp visual texture. The precisely molded louvers consist of 1" deep blades and side reflectors with shielding of 50° lengthwise and 45° cross wise.

Precise brightness control provides excellent UGR and satisfies the recommendations of ANSI IES RP1-12 for intensive VDT viewing with practical spacing criteria of 1.1. Choose from Specular (SPL) or Matte (MPL) louver finish.

HIGH EFFICIENCY LAMBERTIAN OPTIC (HLO) The High-Efficiency Lambertian Optic (HLO) shielding of diffusing 0.075" thick acrylic with up to 88% transmission and good source obscuration is combined with matte white side reflectors to create an efficient optical chamber with uniform luminosity. Luminaire brightness is controlled by the flux-to-shielding area ratio. For visual comfort, avoid high lumen output unless Medius is installed in a high ceiling application. Spacing criteria: 1.2 (longitudinal) x 1.1 (lateral).

LIGHT SOURCE - LED

PERFORMANCE PER 4' AT 4000K (WIO - Indirect 2000 Lumens Output)

SPL

LED output	Color Temp	Watts	Nominal Delivered Lumens	Efficacy LPW
eco low output	4000K	11.5	1400	121
low output	4000K	17	2000	117
medium output	4000K	26.5	3000	113
high output	4000K	36.5	4000	109

MPL

LED output	Color Temp	Watts	Nominal Delivered Lumens	Efficacy LPW
eco low output	4000K	12.5	1400	110
low output	4000K	18.5	2000	107
medium output	4000K	29	3000	103
high output	4000K	40.5	4000	99

Lumen Adjustment Factors

2700K	0.917
3000K	0.959
3500K	0.988
4000K	1.000
6500K	1.053

Custom linear array of alternating color temperature mid-flux LED's are mounted directly to the housing for optimal thermal performance. For the Duo products, a color temperature range from 2700K-6500K is achievable with color points on or below the black body curve. For the Sola products, a color temperature range from 2200K-3500K is controlled synchronously with intensity. Color consistency between fixtures is maintained to within 3SDCM. LEDs are operated at reduced drive current to optimize efficacy and lumen maintenance. All LED's have been tested in accordance with IESNA LM-80-08 and the results have shown L80 lumen maintenance greater than 60,000 hours. Absolute product photometry is measured and presented in accordance with IESNA LM-79, unless otherwise indicated.

LUMINAIRE LENGTH

Medius is made up of standard 4, 8 and 12 foot sections that may be joined together to create longer continuous run lengths. Nominal run length must be noted in the product code. The minimum individual section available is 4 foot.

All individual sections are joined together onsite using the joiner kits provided. LumenWerx offers joiner kits that are extremely simple to work with in the field and result in a fixture that appears virtually seamless with no light leak at any connection.

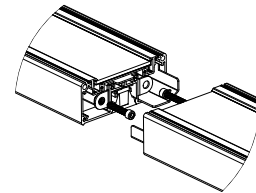

joining system for Medius Direct

CHROMAWERX TUNABLE WHITE AND DIM TO WARM

CHROMAWERX - TUNABLE WHITE

ANSI C78.377-2015

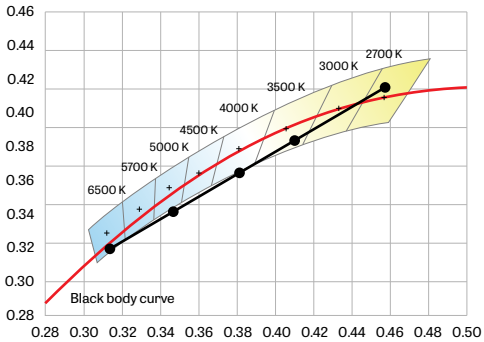

ChromaWerkx Sola is single-channel control that dims output while warming the color temperature in a pre-determined relationship. A simple digital or analog control sends a common signal to dual output digital drivers, which are programmed to adjust a specially populated LED array to emulate the effect of dimming a filament source. Dimming range is programmable but the default option runs from 3500K at 100% of full power to 2200K at 5% of full power. CRI is maintained above 80 throughout the dimming range.

ChromaWerkx Duo is two-channel control. It uses an analog (0-10V) protocol for separate control of luminaire CCT and intensity or a digital (DMX, DALI) protocol for synchronous control of both warm and cool LED arrays to enable the user to set color temperature and light output. Commonly called "tunable white", ChromaWerkx two-channel control provides the range of warm (2700K) to cool (6500K) color that can be useful for helping to entrain circadian rhythms, stimulate alertness for improved educational and work productivity, and compensate for jet lag, among other applications. The ChromaWerkx drivers are programmed to limit maximum light output and power usage across all color temperatures. CRI is maintained above 80.

ELECTRICAL

DMX (Duo only)

Factory-set, adjustable output current, multi-channel LED driver with universal (120-277VAC) input. Using DMX wall controls (optionally supplied by LumenWerkx) or an existing DMX control system, two channels of LEDs (warm-white & cool-white) are independently adjustable. Each DMX driver has multiple output channels that can be independently addressed at the factory or on-site using built-in RDM (Remote Device Management) functionality. Dimming range from 100%-0%. At maximum driver load, efficiency < 89%, PF > 0.9, THD < 20%.

Dali (Duo Only)

Factory-set, adjustable output current LED driver with universal (120-277VAC) input. Using an existing DALI control system (supplied by others), one control channel adjusts the fixture color temperature, and the other control channel adjusts fixture brightness. Dimming range from 100%-0%. At maximum driver load, efficiency < 86%, PF > 0.9, THD < 20%.

0-10V (Sola)

Factory-set, adjustable output current LED driver with universal (120-277VAC) input. Using a single 0-10V control signal, the light output warms in color temperature as it dims down to 1% and 2200K. At maximum driver load, efficiency < 86%, PF > 0.9, THD < 20%.

0-10V (Duo)

Factory-set adjustable output current LED driver with universal (120-277VAC) input. Controlled via two individual 0-10V signals, one for setting light output down to a minimum of 1% and the other for adjusting the CCT (default range of 2700K-6500K). Rated life of 50,000 hours at 70°C maximum driver case temperature and 100% load conditions. Typical efficiency of 86%, PF > 0.9, THD < 20% at 100% load conditions.

Access: Driver is accessible for field service by removing the upright LED and light guide cartridge

CHROMAWERX TUNABLE WHITE AND DIM TO WARM

MOUNTING OPTIONS

Fixtures can be pendant-mounted, using aircraft cables, or stem-mounted.

Unless otherwise specified, LumenWerx provides the following hardware:

Fixed Cable Suspension: aircraft cable mounts at luminaire ends or between modules in continuous runs and is secured by Griplock fastener for leveling.



53WAC36 - Fixed Cables suspensions

Sliding Cable Suspension: Two-part cable assembly slides horizontally for flexible mounting. Griplock fastener secures and levels suspension.



HS53WAC36 - Sliding Cables suspensions

For cable-mounted fixtures - 53WAC36 (5" white canopy for all power mounting point, 3" white canopy for non power mounting point, and a 36" cable)

For stem mounted fixtures - 55WSW18 (5" white canopy for all power mounting point, and non power mounting point, and a 18" white stem)

Caddy clips, if required specify under **OPTIONS**

[For all other options, see our website for a detailed Pendant Mounting Guide](#)

FINISH

Interior - 95%, reflective matte powder coated white paint

Exterior - matte white, matte black or aluminum powder coating

Side reflector - high reflective white coating

Custom finishes are also available.

CONSTRUCTION

Housing - Extruded aluminum 0.085" nominal, matte white or aluminum powder coating

Custom finishes are also available.

End cap - Die cast Aluminum (0.95" nominal)

Joiners - Die cast Aluminum (0.95" nominal)

Reflectors - High reflective white coated bent aluminum

Parabolic louvers - Injection Molded Optical Grade Polycarbonate Vacuum Metalized, up to 95% reflective

Hanger - Chromed Griplock securely attached in end caps and/or joiners with a hex nut

Air craft cable suspension - Fixed 7x7 braids Aluminum air craft cable 0.06" thick
Cable Suspension: aircraft cable mounts at luminaire ends or between modules in continuous runs and is secured by Griplock fastener for leveling.

Sliding Cable Suspension: Two-part cable assembly slides horizontally for flexible mounting. Griplock fastener secures and levels suspension.

Stem - 0.5" diameter threaded steel tube matte white or aluminum powder coating.
Custom finishes are also available

WEIGHT

Medius 4 ft - 8.16 lbs, 3.7kg

Medius 8 ft - 15.09 lbs, 6.9kg

Medius 12 ft - 22.02 lbs, 10kg

CERTIFICATIONS

ETL - Rated for Indoor Dry/Damp locations. Conforms to UL Standard 1598 and certified to CAN/CSA Standard C22.2 No. 250.0.

WARRANTY

For all ChromaWerx products, LumenWerx provides a three-year limited warranty of electrical and mechanical performance of the luminaires, including the LED boards, drivers, and auxiliary electronics. LumenWerx will repair or replace defective luminaires or components at our discretion, provided they have been installed and operated in accordance with our specifications. Other limitations apply, please refer to the full warranty on our website.

Wall controllers are covered by the manufacturer warranty.

CHROMAWERX TUNABLE WHITE

DUO DMX SPECIFICATION

A qualified DMX integrator is required to assure proper installation and commissioning of the DMX network. **When placing the PO, please provide the contact information of your DMX integrator.**

Please answer the following questions to help us identify your DMX network requirements.

YES

Do you require a wall controller provided by Lumenwerx?

NO

DMX control system supplied by others. Lumenwerx will supply DMX-enabled fixtures with default DMX addressing. See following pages for technical DMX informations. ✓

DMX controller supplied by Lumenwerx

How many zones do you have?
A zone consists of one or more luminaires behaving identically.



1 Zone



2 Zones

How to calculate the required number of drivers:

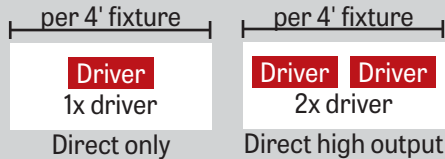

To Calculate # of drivers

1 - 4 Zones

5 or more Zones

Do you have more than 32 drivers in total?

NO

YES

Order a standard Lumenwerx wall controller.

WALL CONTROLLER

WCW - wall controller white
WCB - wall controller black

Add the control code at the end of your order code.

Please provide a fixture layout or RCP (Reflected Ceiling Plan) showing the locations of the DMX fixtures, zones and the DMX wall controller.

Refer to your DMX integrator for the installation. ✓

Subject to factory evaluation. Please contact our controls specialist at controls@lumenwerx.com. Additional cost and equipment will be required. ✓

Subject to factory evaluation and approval. Please contact our controls specialist at controls@lumenwerx.com. Additional cost and equipment will be required. ✓

CHROMAWERX TUNABLE WHITE

GENERIC DMX NETWORK ARCHITECTURE

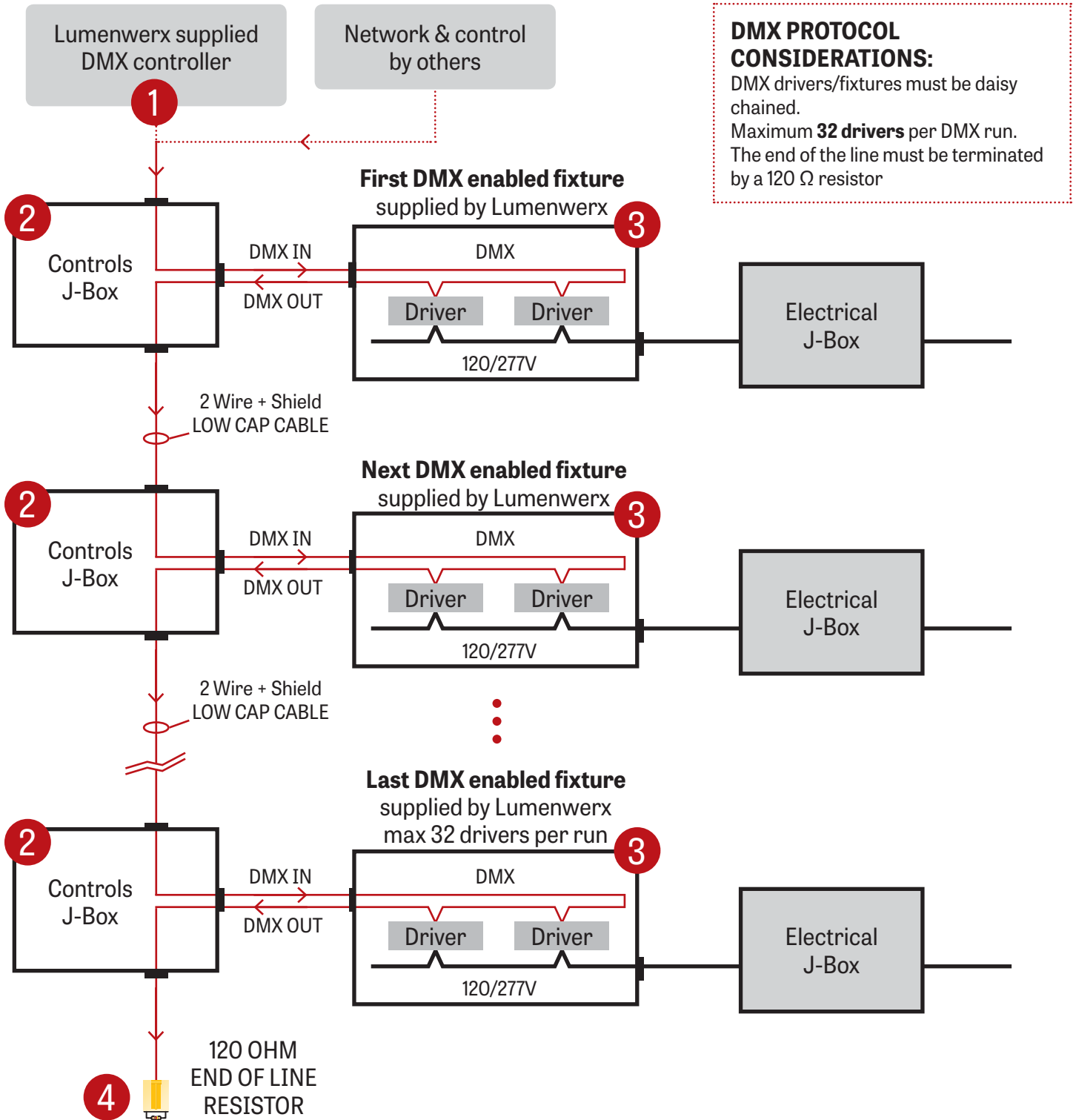

CHROMAWERX TUNABLE WHITE

1 LUMENWERX SUPPLIED DMX CONTROLLER

To the first fixture

WALL BOX SUPPLIED BY OTHERS

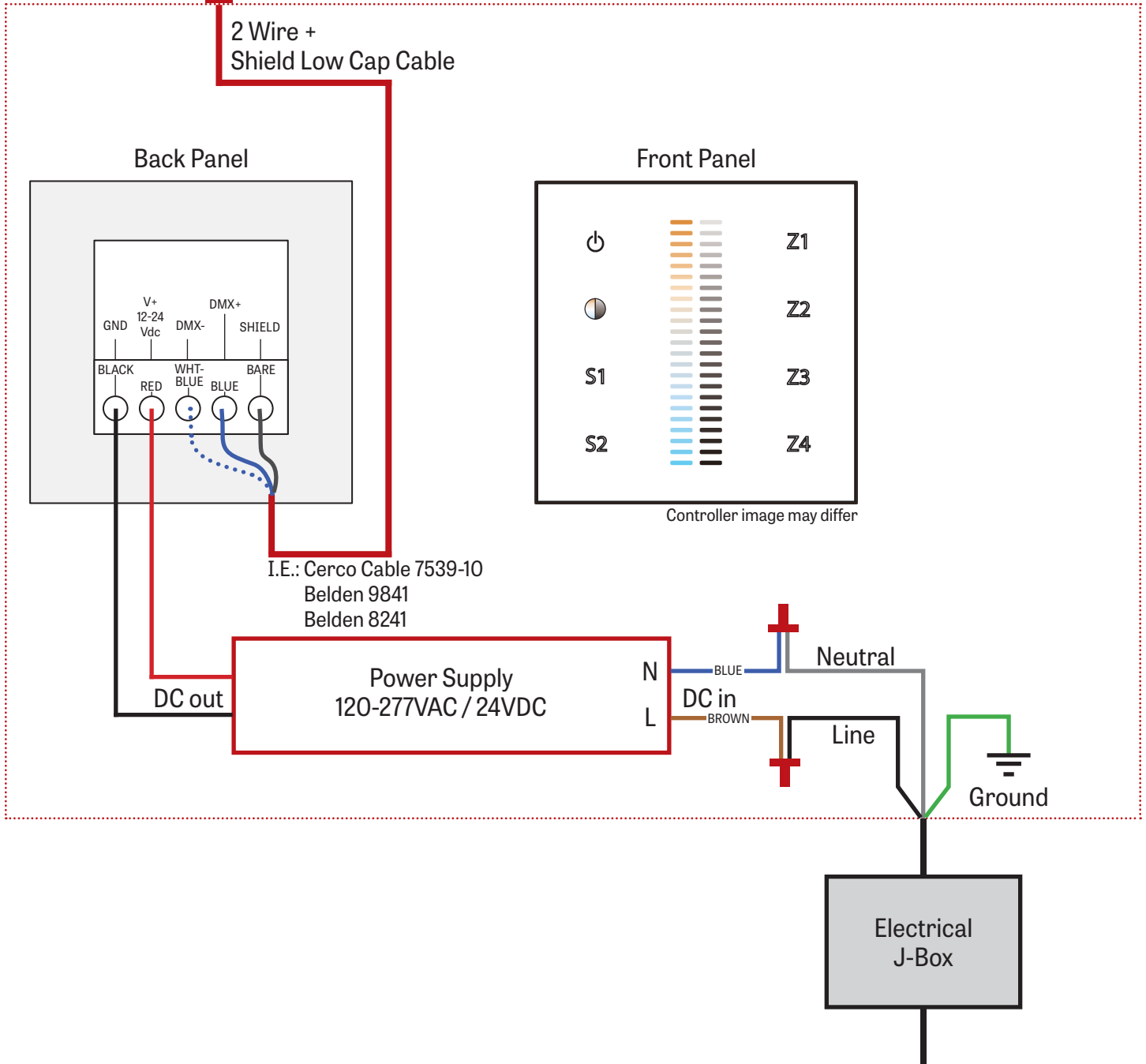

CHROMAWERX TUNABLE WHITE

4 DMX LAST FIXTURE DETAIL

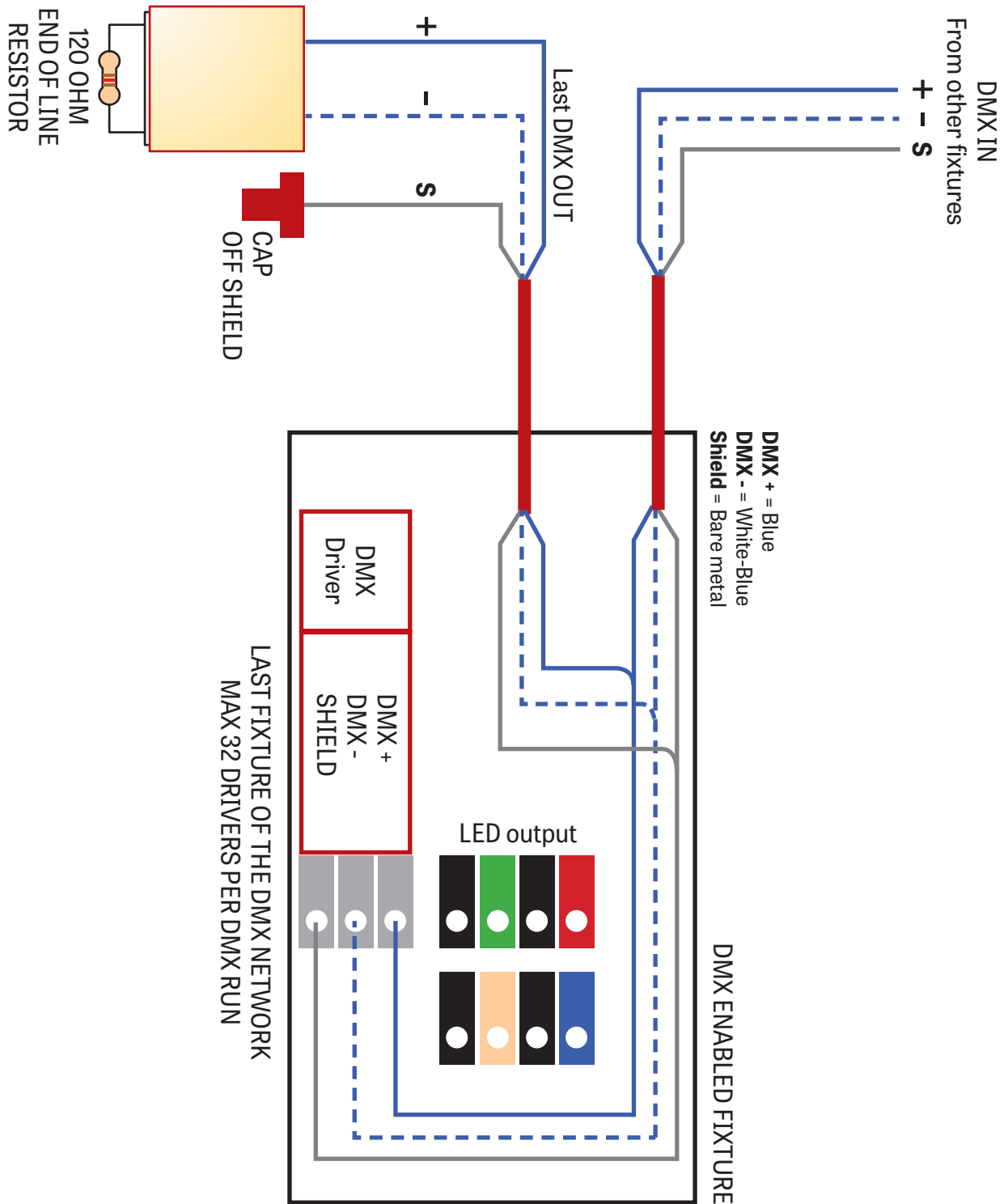

CHROMAWERX TUNABLE WHITE

DMX WALL CONTROLLER

DUO 1-4 ZONE

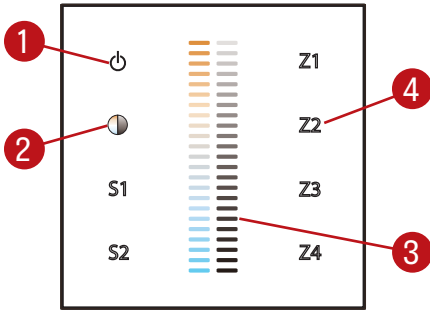

- (1) Power: Use this button to turn ON or OFF the fixture
- (2) Brightness/CCT: Use the color/brightness toggle button to chose between color/brightness. when Blue: brightness is selected, when Yellow: color is selected.
- (3) Slider: Depending on the mode chosen in 2, the slider will allow the user to set desired color or brightness.
- (4) Zone select: Up to 4 zones can be selected either independently or together. Once selected the commands will be sent to the zone identified by a Blue LED.

Default DMX Addresses:

- 1 Warm
- 2 Cool

MEDIUS LED

PENDANT DIRECT

LUMENWERX
WWW.LUMENWERX.COM

CHROMAWERX TUNABLE WHITE AND DIM TO WARM

PERFORMANCE WITH SPECULAR PARABOLIC LOUVER (SPL)

350 LUMEN AT 80CRI - ECO LOW OUTPUT

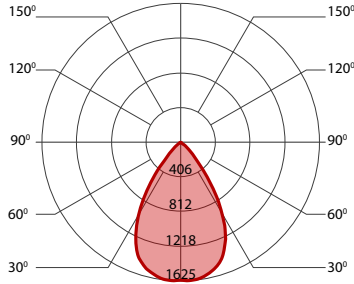

PERFORMANCE PER 4'

LED output	Color Temp	Watts	Nominal Delivered Lumens	Efficacy LPW
eco low output	2200K	17.5	1400	79
eco low output	3000K	12	1400	119
eco low output	3500K	12	1400	119
eco low output	4000K	11.5	1400	121
eco low output	6500K	11	1400	125

500 LUMEN AT 80CRI - LOW OUTPUT

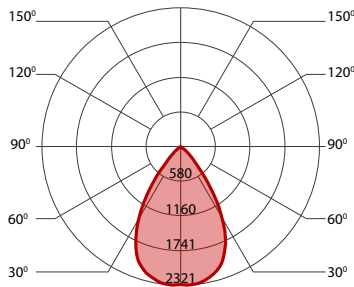

PERFORMANCE PER 4'

LED output	Color Temp	Watts	Nominal Delivered Lumens	Efficacy LPW
low output	2200K	26	2000	77
low output	3000K	17.5	2000	115
low output	3500K	17.5	2000	115
low output	4000K	17	2000	117
low output	6500K	16.5	2000	121

750 LUMEN AT 80CRI - MEDIUM OUTPUT

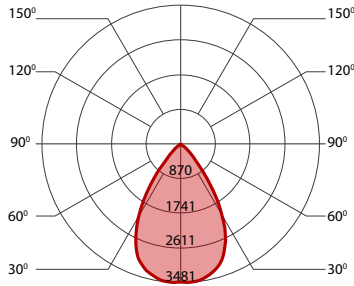

PERFORMANCE PER 4'

LED output	Color Temp	Watts	Nominal Delivered Lumens	Efficacy LPW
medium output	2200K	41	3000	73
medium output	3000K	27	3000	111
medium output	3500K	27	3000	111
medium output	4000K	26.5	3000	113
medium output	6500K	25.5	3000	117

1000 LUMEN AT 80CRI - HIGH OUTPUT

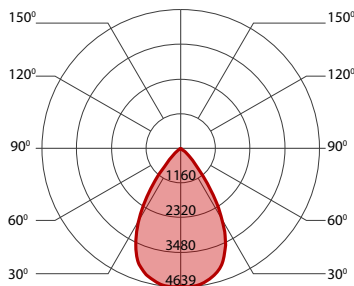

PERFORMANCE PER 4'

LED output	Color Temp	Watts	Nominal Delivered Lumens	Efficacy LPW
high output	2200K	57	4000	70
high output	3000K	37.5	4000	107
high output	3500K	37.5	4000	107
high output	4000K	36.5	4000	109
high output	6500K	35.5	4000	113

MEDIUS LED

PENDANT DIRECT

CHROMAWERX TUNABLE WHITE AND DIM TO WARM

PERFORMANCE WITH MATTE PARABOLIC LOUVER (MPL)

350 LUMEN AT 80CRI - ECO LOW OUTPUT

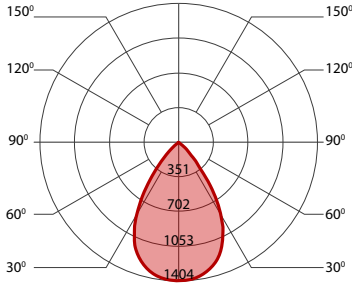

PERFORMANCE PER 4'

LED output	Color Temp	Watts	Nominal Delivered Lumens	Efficacy LPW
eco low output	2200K	19.5	1400	72
eco low output	3000K	13	1400	108
eco low output	3500K	13	1400	108
eco low output	4000K	12.5	1400	110
eco low output	6500K	12.5	1400	114

500 LUMEN AT 80CRI - LOW OUTPUT

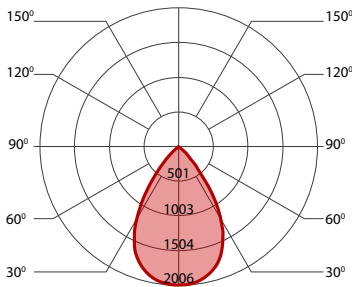

PERFORMANCE PER 4'

LED output	Color Temp	Watts	Nominal Delivered Lumens	Efficacy LPW
low output	2200K	28.5	2000	70
low output	3000K	19	2000	105
low output	3500K	19	2000	105
low output	4000K	18.5	2000	107
low output	6500K	18	2000	110

750 LUMEN AT 80CRI - MEDIUM OUTPUT

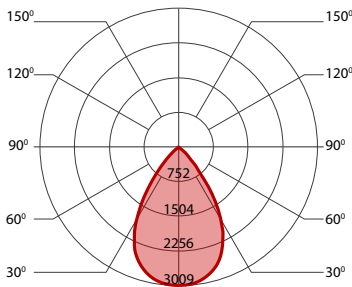

PERFORMANCE PER 4'

LED output	Color Temp	Watts	Nominal Delivered Lumens	Efficacy LPW
medium output	2200K	45.5	3000	66
medium output	3000K	29.5	3000	101
medium output	3500K	29.5	3000	101
medium output	4000K	29	3000	103
medium output	6500K	28.5	3000	106

1000 LUMEN AT 80CRI - HIGH OUTPUT

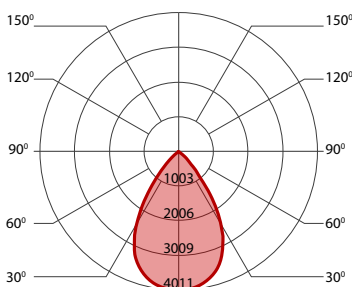

PERFORMANCE PER 4'

LED output	Color Temp	Watts	Nominal Delivered Lumens	Efficacy LPW
high output	2200K	63.5	4000	63
high output	3000K	41	4000	98
high output	3500K	41	4000	98
high output	4000K	40.5	4000	99
high output	6500K	39	4000	103