

# PETITE MULTI-APERTURE ROUND RECESSED ADJUSTABLE

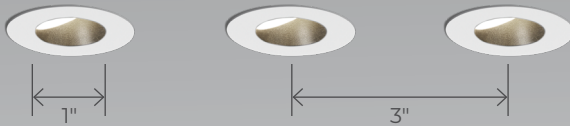

1 X 3  
Adjustable Cut Cone  
Flanged Trim



1 X 2  
Adjustable  
Trimless



The Petite family strikes that perfect balance of compact size, streamlined aesthetics, and high performance. Through their 1" lens apertures, these meticulously engineered downlight, cylinder, and multi-aperture luminaires breathe light into spaces with a quiet, straightforward sophistication.

### Array



### Beam Angles



### Light Source



### Ceiling Types



### Plenum Clearance

As low as 1 3/4"



### Petite Family (Refer to other spec sheets)

#### Downlight



Adjustable



Recessed



Wall Wash

#### Multi-aperture



Adjustable



Recessed



Wall Wash

#### Cylinder



Pendant



Surface

# PETITE MULTI-APERTURE ROUND RECESSED ADJUSTABLE



Project: \_\_\_\_\_

Type: \_\_\_\_\_

## Order Guide

LUMINAIRE ID <sup>1</sup>	ARRAY	TRIM STYLE	LENS	CEILING THICKNESS	INSTALLATION TYPE <sup>4</sup>	MOUNTING OPTION <sup>8</sup>
<b>UP TO 15°</b> <b>PETMRA15</b> <sup>2</sup> - Petite Multi-aperture Round Recessed Adjustable  <b>UP TO 30°</b> <b>PETMRA30</b> <sup>3</sup> - Petite Multi-aperture Round Recessed Adjustable Cut Cone  <sup>1</sup> Recessed (fixed) and Recessed Wall Wash also available. Consult other spec sheets. <sup>2</sup> Adjustability: Up to 15° tilt, 355° rotation. <sup>3</sup> Adjustability: Up to 30° tilt, 355° rotation.	<b>1X2M</b> - 1 X 2 <b>1X3M</b> - 1 X 3	<b>PETRA15 Adjustable</b> <b>TRM</b> - Flanged trim <b>TRMP</b> - Flush flanged trim drywall mudplate <b>TRMW</b> - Flush flanged trim millwork <b>TLMP</b> - Trimless drywall mudplate <b>TLMW</b> - Trimless millwork <b>GLR</b> - Glow ring	<b>PETRA30 Adjustable Cut Cone</b> <b>TRMC</b> - Flanged trim cut cone <b>TRMPC</b> - Flush trim drywall mudplate cut cone <b>TRMWC</b> - Flush trim drywall millwork cut cone  <b>At baffle</b> <b>SDL</b> - Soft diffused lens, Solite <b>NOL</b> - No lens	<b>1IN</b>	<b>IC</b> <sup>5,6</sup> - Type-IC <b>NIC</b> <sup>7</sup> - Type Non-IC <b>CP</b> - Chicago Plenum Type-IC (CCEA)  <sup>4</sup> See page 3 for more details. <sup>5</sup> Not available with 1X3 array. <sup>6</sup> Up to 7 W in 1 X 2 array. <sup>7</sup> Up to 10 W for 1 X 2 array. Up to 7 W in 1 X 3 array.	<b>ASB</b> - Adjustable standard bar hangers <b>FMB</b> - Flush mount bars <b>ACB</b> - Adjustable commercial bar hangers <b>AHC</b> - Adjustable hat channel bars <b>NA</b> - None  <sup>8</sup> See page 5 for more details.

LIGHT SOURCE	BEAM	COLOR QUALITY	CRI	COLOR TEMPERATURE	DRIVER
<b>SW</b> - Static white	<b>35DEG</b> - 35° Narrow flood <b>45DEG</b> - 45° Flood <b>60DEG</b> <sup>9</sup> - 60° Very wide flood  <sup>9</sup> Only available with TLMP and TLMW trim options. <sup>10</sup> Not available with TLMP and TLMW trim options.	<b>2STP</b> - 2 Step MacAdam Ellipse <b>3STP</b> - 3 Step MacAdam Ellipse	<b>90CRI</b> - 90 CRI <b>95CRI</b> - 95 CRI <b>80CRI</b> - 80 CRI	<b>27K</b> - 2700K <b>30K</b> - 3000K <b>35K</b> - 3500K <b>40K</b> - 4000K	<b>INTEGRAL</b> <sup>11</sup>
<b>SOLA</b> - Dim-to-warm single channel control <b>DUO</b> - Tunable white 2-channel control	<b>45DEG</b> <sup>10</sup> - 45° Flood <b>60DEG</b> <sup>10</sup> - 60° Very wide flood	<b>3STP</b> - 3 Step MacAdam Ellipse	<b>90CRI</b> - 90 CRI	<b>SOLA</b> <b>30K18K</b> - 3000K to 1800K <b>27K18K</b> - 2700K to 1800K  <b>DUO</b> <b>65K27K</b> - 6500K to 2700K <b>50K27K</b> - 5000K to 2700K	<b>REMOTE</b> <sup>12</sup>  <sup>11</sup> Access above the ceiling is required. <sup>12</sup> A remote driver box is provided, see page 4 for details.

VOLTAGE	WATTAGE PER LIGHT	DIMMING <sup>16</sup>	BAFFLE FINISH Specify NA for Glow ring	TRIM FLANGE FINISH Specify NA for Glow Ring and Trimless
<b>120V</b> - 120V <b>277V</b> - 277V <b>UNV</b> - 120V-277V <b>347V</b> <sup>13</sup> - 347V  <sup>13</sup> Available with RD1 driver only. Please consult factory.	<b>7W</b> - 7 W, up to 505 lm <b>10W</b> <sup>14</sup> - 10 W, up to 667 lm  <b>SOLA</b> <b>10W</b> <sup>14</sup> - 10 W output, up to 357 lm  <b>DUO</b> <b>7W</b> <sup>15</sup> - 7 W output, up to 266 lm	<b>D1</b> - 1% 0-10V <b>ELV</b> <sup>17</sup> - ELV 120V <b>TRI</b> <sup>17</sup> - TRIAC 120V  <sup>16</sup> PoE (Power-over-Ethernet) compatible. Consult factory for details. <sup>17</sup> Available with 120V only.	<b>FTMW</b> - Textured matte white <b>FTMB</b> - Textured matte black <b>FSPC</b> - Specular <b>FSSPC</b> - Semi-specular <b>FCHP</b> - Champagne <b>CF#</b> - Custom finish, specify RAL# <b>NA</b> - Not applicable	<b>FTMW</b> - Textured matte white <b>FTMB</b> - Textured matte black <b>FSPC</b> - Specular <b>FSSPC</b> - Semi-specular <b>FCHP</b> - Champagne <b>CF#</b> - Custom finish, specify RAL# <b>NA</b> - Not applicable

FOR FULL REMOTE DRIVER SPECIFICATION, SEE "REMOTE DRIVER" SECTION BELOW.

## REMOTE DRIVER RD1, RELV, RTRI, RSD1, RSELV, RSTRI OPTIONS

REMOTE DRIVER <sup>18</sup>	LUMINAIRE QTY.	LUMINAIRE ID	VOLTAGE	WATTAGE	DIMMING <sup>24</sup>
<b>RDB</b> - Remote driver  <sup>18</sup> Specify each required remote driver box on a separate line.	<b>1X</b> - 1 luminaire <b>2X</b> - 2 luminaires <b>3X</b> - 3 luminaires	<b>UP TO 15°</b> <b>PETMRA15</b> <sup>19</sup> - Petite Multi-aperture Round Recessed Adjustable  <b>UP TO 30°</b> <b>PETMRA30</b> <sup>20</sup> - Petite Multi-aperture Round Recessed Adjustable Cut Cone <sup>19</sup> Adjustability: Up to 15° tilt, 355° rotation. <sup>20</sup> Adjustability: Up to 30° tilt, 355° rotation.	<b>120V</b> - 120V <b>277V</b> - 277V <b>UNV</b> - 120V-277V <b>347V</b> <sup>21</sup> - 347V  <sup>21</sup> Available with RD1 driver only. Please consult factory.	<b>7W</b> - 7 W, up to 505 lm <b>10W</b> <sup>22</sup> - 10 W, up to 667 lm  <b>SOLA</b> <b>10W</b> <sup>22</sup> - 10 W output, up to 357 lm  <b>DUO</b> <b>7W</b> <sup>23</sup> - 7 W output, up to 266 lm  <sup>22</sup> Only available in 1 X 2 array with Type-NIC. <sup>23</sup> Not available with Type-IC.	<b>RD1</b> - 1% 0-10V <b>RELV</b> <sup>25</sup> - ELV 120V <b>RTRI</b> <sup>25</sup> - TRIAC 120V <b>RLDE1</b> <sup>26</sup> - Lutron Hi-lume 1% Eco <b>RDA</b> <sup>26</sup> - DALI  <b>SOLA</b> <b>RSD1</b> - Single 0-10V input <b>RSELV</b> <sup>25</sup> - ELV 120V <b>RSTRI</b> <sup>25</sup> - TRIAC 120V  <b>DUO</b> <b>RDMX</b> <sup>26</sup> - DMX <b>RDDA</b> <sup>26</sup> - DALI DT6 <b>RDDA8</b> <sup>26</sup> - DALI DT8  <sup>24</sup> For configurations involving different sizes on a remote driver, please consult factory. <sup>25</sup> Available with 120V only. <sup>26</sup> On-site commissioning is required. <sup>27</sup> For emergency battery, code will be like the following example: RD1+EB.
<b>EXAMPLE CODE:</b>	<b>LIGHT</b>	PETMRA15-TRM-SDL-1IN-IC-ASB-35DEG-2STP-90CRI-35K-UNIV-7W-D1-FTMW-FTMW			<b>REMOTE DRIVER</b>
					RDBC-2X-PETMRA15-RD1 RDBC-1X-PETMRA15-RD1



# PETITE MULTI-APERTURE ROUND RECESSED ADJUSTABLE



## Installation Types

IC - Type-IC NIC - Type-Non IC		
INTEGRAL	1X2M - 1 X 2	1X3M - 1 X 3
REMOTE	1X2M - 1 X 2	1X3M - 1 X 3

- For dimension B, see the PLENUM CLEARANCE table below.

### PLENUM CLEARANCE

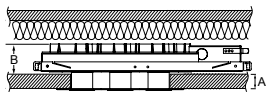

IC - Insulated ceiling

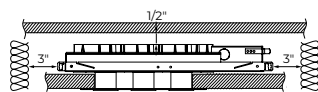

NIC \* - Non insulated ceiling  
\* No insulation within 3" of the fixture.

### CUT-OUT DIMENSIONS

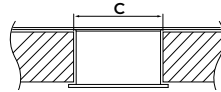

TRM - TLMP - TRMP - GLR  
TRMC - TRMPC

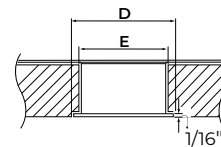

TRMW  
TRMWC

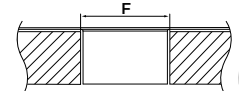

TLMW

PLENUM CLEARANCE HEIGHT AND CEILING THICKNESS			
		IC - TYPE IC	NIC - TYPE NON-IC
<b>A</b>	Ceiling Thickness	1IN	1IN
<b>B</b>	Integral Remote	2 1/8" (FMB) 4" (ASB, ACB,AHC)	2 5/8" (FMB) 4" (ASB, ACB,AHC)

	PETMRA15 Adjustable	PETMRA30 Adjustable Cut Cone	CUT-OUT DIMENSIONS		
			Drywall	Acoustix Tile	Millwork
<b>C</b>	TRM	TRMC	Ø 111/16"		N/A
	TRMP / TLMP	TRMPC	Ø 111/16"	N/A	
	GLR	NA	Ø 111/16"		
<b>D</b>	TRMW	TRMWC	N/A		Ø 113/16"
<b>E</b>	TLMW	NA	N/A		Ø 111/16" with 1/6" lip
<b>F</b>	TLMW	NA	N/A	Ø 111/16"	

# PETITE MULTI-APERTURE ROUND RECESSED ADJUSTABLE



## REMOTE DRIVER BOX

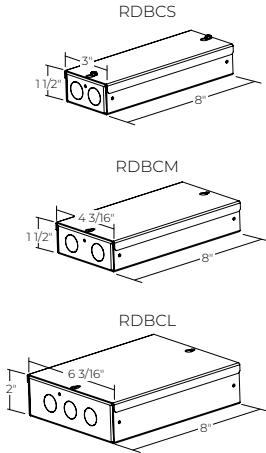

DRIVER	RDB	# DRIVERS
RD1	RDBCS	1X
	RDBCM	2X
	RDBCL	3X
RELV RTRI RDA RELD0 RELD1	RDBCS	1X
	RDBCM	2X, 3X

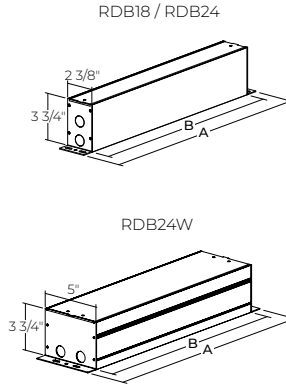

DRIVER	RDB	A	B
RLDE1	RDB18	20"	18"
RDMX RDDA RDDA8 RDD1 RPSQ0	RDB24	26"	24"
RD1+EB RELV+EB RTRI+EB			
RLDE1+EB RDA+EBI RELD1+EB RELD0+EB			
	RDB24W	26"	24"

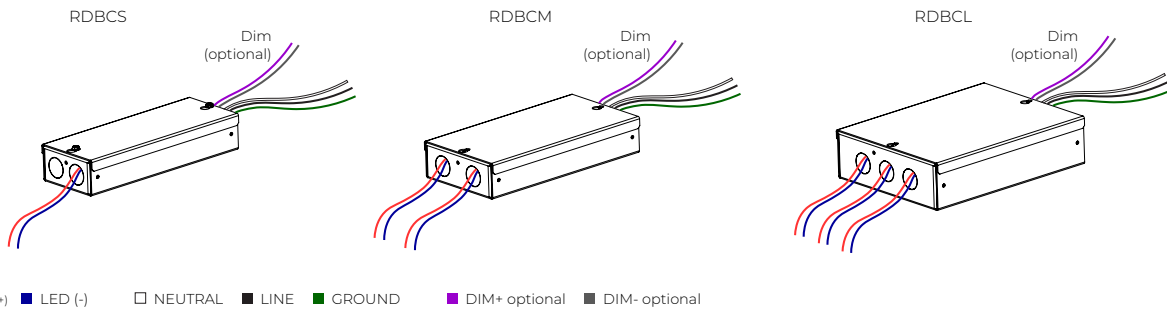

# PETITE MULTI-APERTURE ROUND RECESSED ADJUSTABLE



## Mounting Options

### ASB - Adjustable Standard Bar Hangers

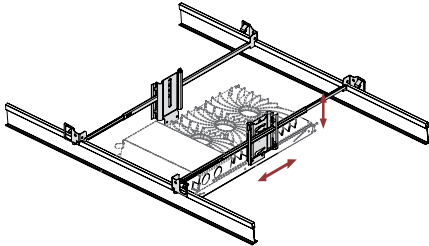

Adjustable Standard Bar hangers can be used in both commercial and residential applications and are adjustable to various heights in both Grid Ceiling and Drywall mounting. ASB hangers are less rigid and versatile than ACB hangers.

### FMB - Flush Mount Bars

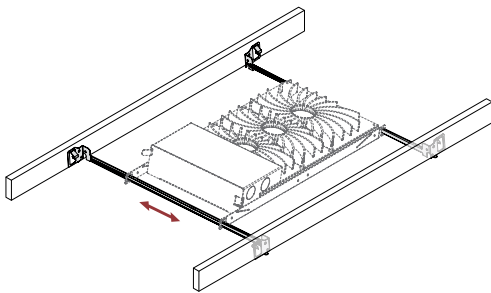

Flush Mount Bars are best used in residential applications, fitting snug to the surface and suitable for Wood, Metal, and Drywall mounting. The flush mounted bars are static and can't be adjusted.

### ACB - Adjustable Commercial Bar Hangers

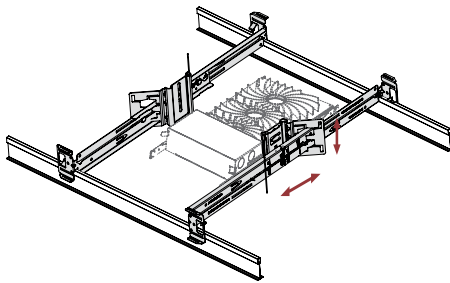

Adjustable Commercial Bar hangers can be used in both commercial and residential applications and are by far the most versatile mounting bar we offer with its adjustability to various heights. ACB hangers are suitable for Grid Ceiling, Drywall, Metal, Wood and Frame mounting.

- Extremely rigid
- Fits into C-Channel notches in a Butterfly Bracket

### AHC - Adjustable Hat Channel Bars

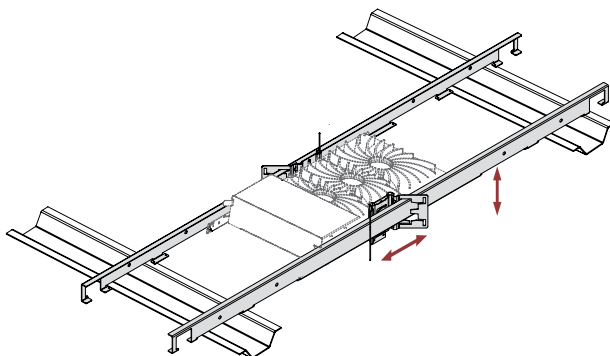

Adjustable Hat Channel bars can be used in both commercial and residential applications and come with a butterfly clip to adjust to various heights. AHC bars can be hung downward by 90 degrees in vertical position, and once wired, can be shifted onto the horizontal mounting plane. AHC bars are suitable for both Drywall and wood ceiling applications.

# PETITE MULTI-APERTURE ROUND RECESSED ADJUSTABLE



## Trim Style

RECESSED ADJUSTABLE

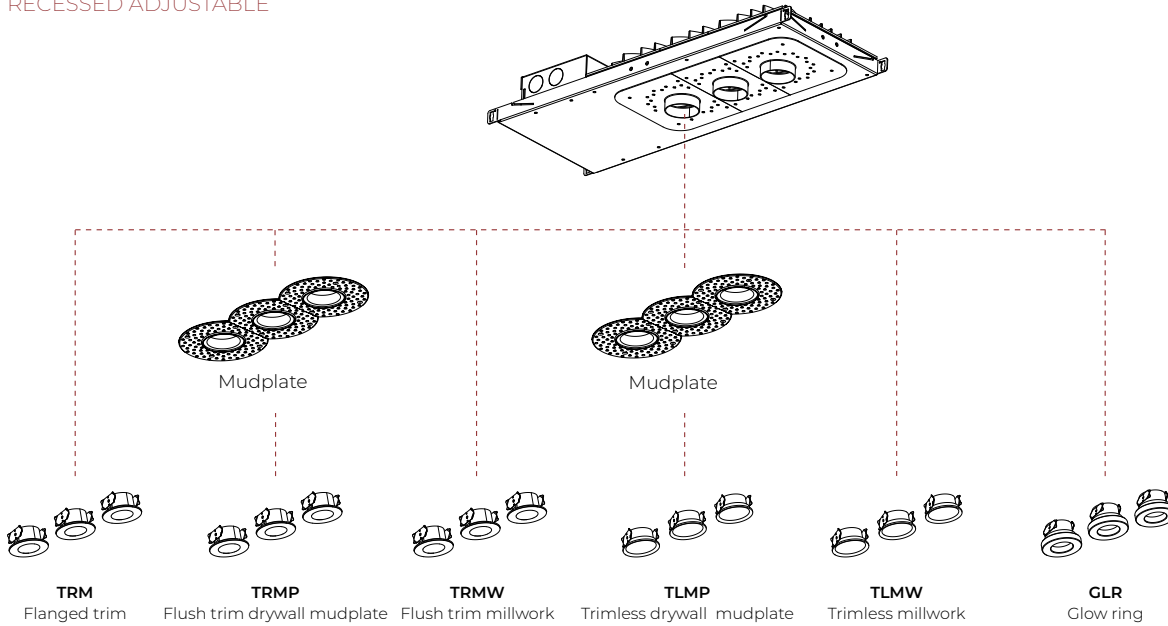

## Lens

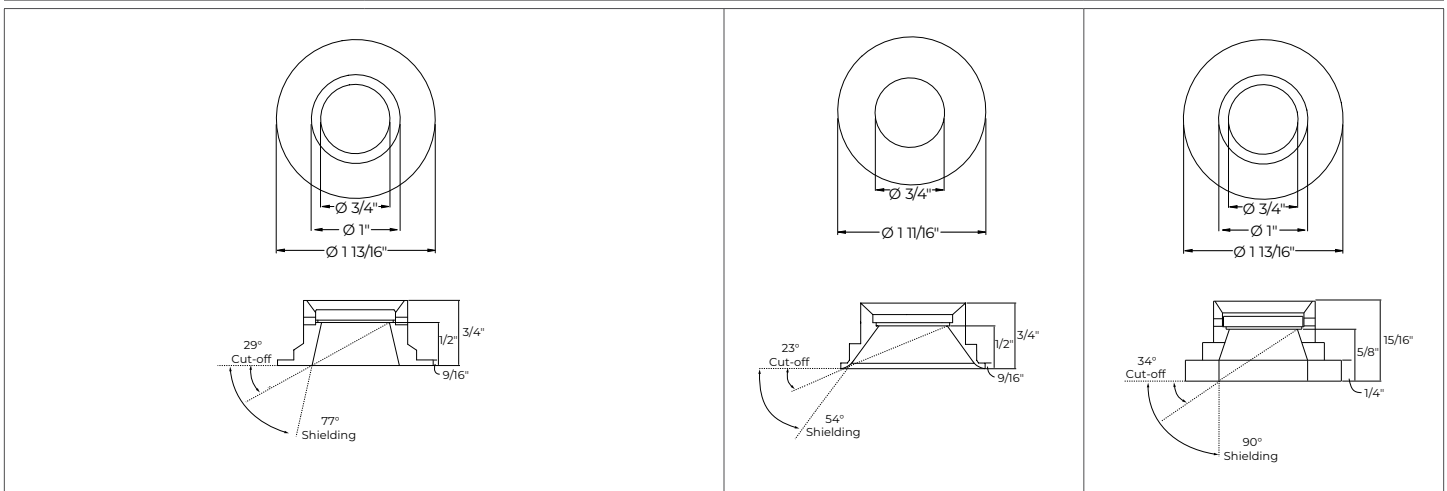
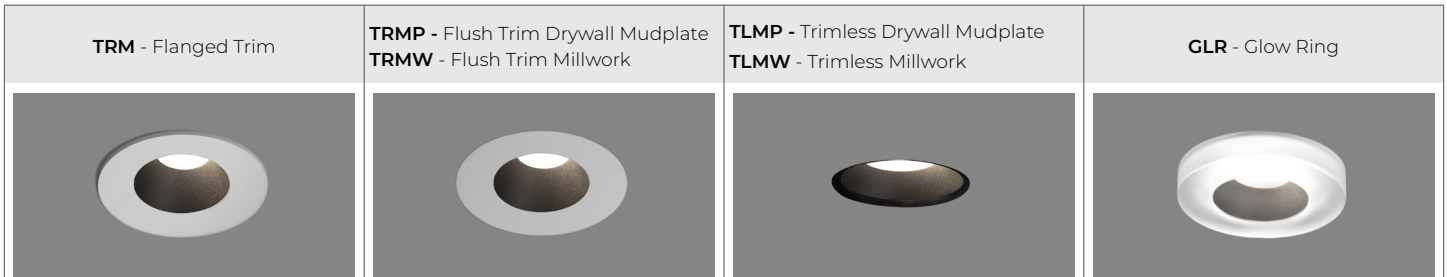
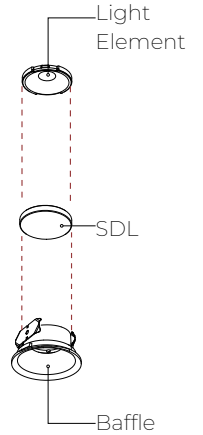

# PETITE MULTI-APERTURE ROUND RECESSED ADJUSTABLE



## Trim Style

### RECESSED ADJUSTABLE CUT CONE

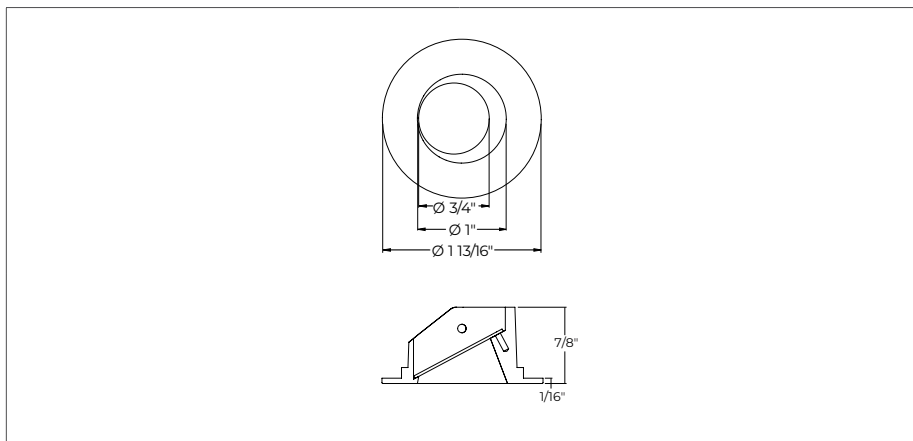
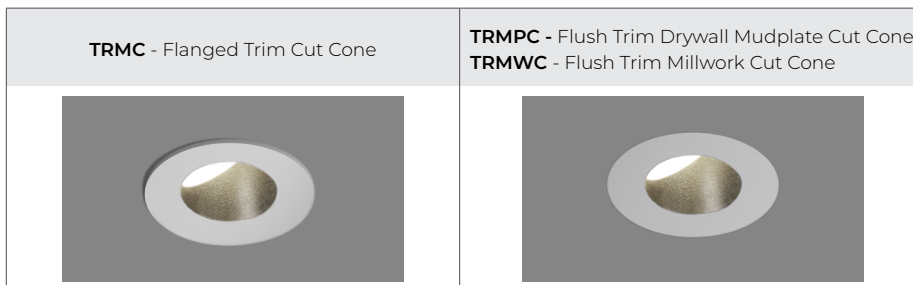
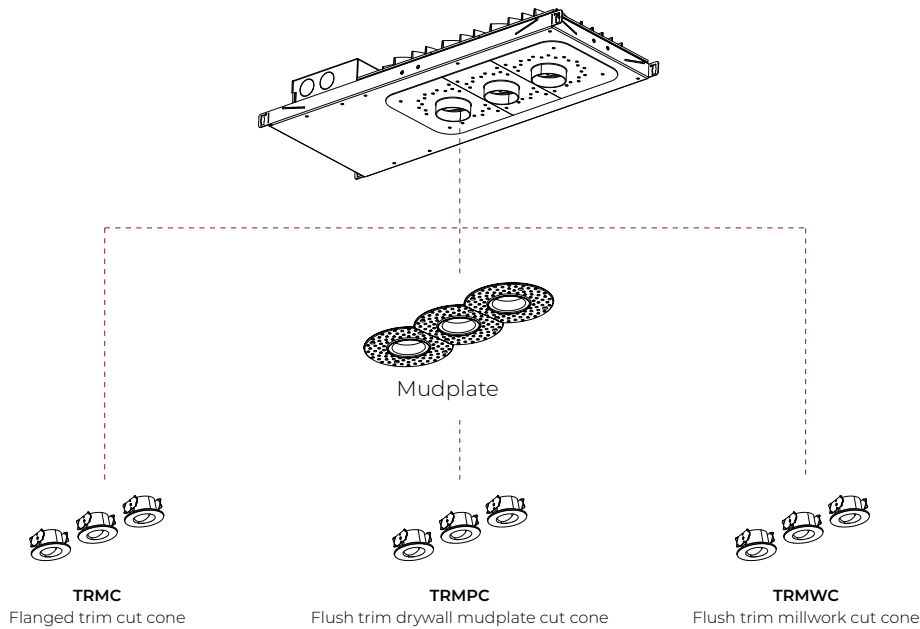

# PETITE MULTI-APERTURE ROUND RECESSED ADJUSTABLE



## Color Quality

### COLOR QUALITY - 3500K

TM-30 R <sub>r</sub>	91
TM-30 R <sub>a</sub>	100
CRI	90
R9	> 50

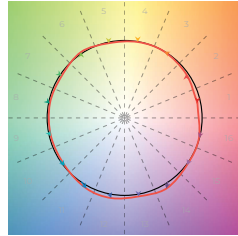

## Photometrics

The light distribution will vary depending on baffle finish and trim style.

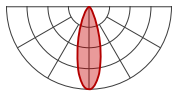

**35DEG** - 35° Narrow flood

Delivered Lumens - At 3500K, 90 CRI, with No Lens. Efficacy Based on Delivered Lumens

		ADJUSTABLE 0-15						ADJUSTABLE 0-30					
WATTAGE		7W		10W		14W		7W		10W		14W	
Trim Style	Baffle Finish	lm	lm/W	lm	lm/W	lm	lm/W	lm	lm/W	lm	lm/W	lm	lm/W
Trim	White	425	61	529	53	712	51	359	51	512	51	717	51
	Black Champagne	327	47	432	43	581	41	330	47	472	47	661	47
	Specular Semi-specular	382	54	505	50	679	48	357	51	509	51	713	51
Trimless	White	449	64	592	59	797	57	NA	NA	NA	NA	NA	NA
	Black Champagne	413	59	545	54	734	52	NA	NA	NA	NA	NA	NA
	Specular Semi-specular	283	40	589	59	793	57	NA	NA	NA	NA	NA	NA
Glow Ring		406	58	535	53	720	51	NA	NA	NA	NA	NA	NA

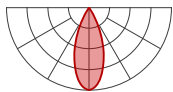

**45DEG** - 45° Flood

Delivered Lumens - At 3500K, 90 CRI, with No Lens. Efficacy Based on Delivered Lumens

		ADJUSTABLE 0-15						ADJUSTABLE 0-30					
WATTAGE		7W		10W		14W		7W		10W		14W	
Trim Style	Baffle Finish	lm	lm/W	lm	lm/W	lm	lm/W	lm	lm/W	lm	lm/W	lm	lm/W
Trim	White	425	61	561	56	755	54	359	51	584	58	818	58
	Black Champagne	344	49	454	45	611	44	330	47	504	50	705	50
	Specular Semi-specular	407	58	538	54	724	52	357	51	556	56	778	55
Trimless	White	505	72	667	67	897	64	NA	NA	NA	NA	NA	NA
	Black Champagne	436	62	575	57	774	55	NA	NA	NA	NA	NA	NA
	Specular Semi-specular	481	69	634	63	854	61	NA	NA	NA	NA	NA	NA
Glow Ring		408	58	539	54	725	52	NA	NA	NA	NA	NA	NA



# PETITE MULTI-APERTURE ROUND RECESSED ADJUSTABLE

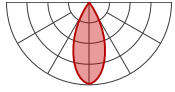

60DEG - 60° Very wide flood

Delivered Lumens - At 3500K, 90 CRI, with No Lens. Efficacy Based on Delivered Lumens

		ADJUSTABLE 0-15						ADJUSTABLE 0-30					
WATTAGE		7W		10W		14W		7W		10W		14W	
Trim Style	Baffle Finish	lm	lm/W	lm	lm/W	lm	lm/W	lm	lm/W	lm	lm/W	lm	lm/W
Trim	White	NA	NA	NA	NA	NA	NA	NA	NA	NA	NA	NA	NA
	Black Champagne	NA	NA	NA	NA	NA	NA	NA	NA	NA	NA	NA	NA
	Specular Semi-specular	NA	NA	NA	NA	NA	NA	NA	NA	NA	NA	NA	NA
Trimless	White	318	45	419	42	564	40	NA	NA	NA	NA	NA	NA
	Black Champagne	247	35	326	33	439	31	NA	NA	NA	NA	NA	NA
	Specular Semi-specular	283	40	373	37	502	36	NA	NA	NA	NA	NA	NA
Glow Ring		NA	NA	NA	NA	NA	NA	NA	NA	NA	NA	NA	NA

## MULTIPLIERS

Please follow the multiplier tables to ensure correct lumen value. CCT, CRI, and lensing will change the lumen value.

CCT		CRI		LENS	
2700K	0.91	80 CRI	1	SDL-Soft diffused lens, Solite	0.91
3000K	0.96	90 CRI	1	No lens	1
3500K	1	95 CRI	0.77		
4000K	1.01				

For SOLA and DUO, please consult factory.



# PETITE MULTI-APERTURE ROUND RECESSED ADJUSTABLE



## Technical Specifications

### OPTIC

The CircaFlex™ Optic uses advanced beam-splitting technology to allow light to follow an intended optical path with maximal precision, minimal spread, and even distribution.

### LIGHT SOURCE

Compact COB (Chip-On-Board) LED module, available in 2700K, 3000K, 3500K and 4000K with a choice of 80 CRI, 90 CRI, or 95 CRI, with elevated R9 value for 90 CRI and above. Color consistency is maintained to within 2 SDCM. All LEDs have been tested in accordance with IESNA LM-80-08 and the results have shown L80 lumen maintenance greater than 60,000 hours. Absolute product photometry is measured and presented in accordance with IESNA LM-79, unless otherwise indicated.

### CHROMAWERX

#### Chromawerx SOLA

Chromawerx SOLA is single-channel control that dims output while warming the color temperature in a pre-determined relationship. Two color temperature range options are offered: 3000K to 1800K, and 2700K to 1800K. A simple analog control adjusts a specially populated LED array to emulate the effect of dimming a filament source.

#### Chromawerx DUO

Chromawerx DUO offers a two-channel control system which uses analog or digital protocols for synchronous control of both cool to warm LED arrays - maintaining a CRI above 90. Two color temperature range options are offered: 6500K to 2700K, and 5000K to 2700K. The range of color DUO offers is useful for entraining circadian rhythms, stimulating alertness, and compensating for jet lag among other applications. The Chromawerx drivers are programmed to limit maximum light output and power usage across all color temperatures. When paired with DALI drivers (DDA/DDA8), color tuning follows a linear dimming curve.

### ELECTRICAL

Unless otherwise specified, dimming down to 1%. At maximum driver load: efficiency>84%, PF>0.9, THD<20%.

**Integral:** 1% 0-10V, ELV 120V, TRIAC 120V, eldoLED 1% EcoDrive 0-10V, eldoLED 0.1% SOLOdrive 0-10V, Lutron Hi-lume Premier 0.1% EcoSystem.

**Remote:** 1% 0-10V, ELV 120V, TRIAC 120V, Lutron Hi-lume 1% Eco, DALI, eldoLED 1% EcoDrive 0-10V, eldoLED 0.1% SOLOdrive 0-10V, Lutron Hi-lume Premier 0.1% EcoSystem, DMX, Lutron T-series (tunable white).

**Emergency Battery Options:** Remotely-installed, long-life, high-temperature, maintenance-free, Bodine Lithium-Ion battery pack with self-test functionality, test switch and charge indicator. IOTA and Fulham options available upon request. Minimum of 90 minutes operation, and recharge time of 24 hours. For fixtures less than 10W, the battery provides 6W of emergency light output. For fixtures 10W and over, the battery provides 10W.

### PoE

Depending on the PoE manufacturer selected, Lumenwerx will install the node in factory as either integral to the luminaire, or as a remote module. Factory programming of the PoE node may or may not enable the following functionalities: lumen package, DUO (tunable white), emergency battery backup, and sensor integration. These must be addressed and evaluated on a case-by-case basis.

### CONSTRUCTION

#### Housing

For new construction, 20 gauge powder coated steel. 18 gauge galvanized steel junction box with ½" trade size knockouts. Adjustable hanger bars and butterfly brackets are included. Adjustable commercial hat channel and flush mounted brackets are also available.

**Baffle:** Die-cast aluminum mounted with retaining spring clips

**Glow ring:** Acrylic (Not available with PETMRA30)

**Heat sink:** Die-cast aluminum

### WEIGHT

	1 X 2	1 X 3
<b>Integral</b>	5.1 lbs - 2.3 kg	6.2 lbs - 2.8 kg
<b>Remote</b>	3.2 lbs - 1.4 kg	4.2 lbs - 1.9 kg

### LENS



Soft diffused lens,  
Solite

### ENVIRONMENT

Ambient temperature at fixture location shall be within 0°C/32°F - 25°C/77°F, indoor dry or damp as well as outdoor damp use (canopies or marquees)

# PETITE MULTI-APERTURE ROUND RECESSED ADJUSTABLE



## CERTIFICATION

**ETL** - Rated for Indoor dry/damp locations. Conforms to UL Standard 1598 and certified to CAN/CSA Standard C22.2 No. 250.0

## WARRANTY

Lumenwerx provides a five-year limited warranty on electrical and mechanical performance of the luminaires, including the LED boards, drivers, and auxiliary electronics. Lumenwerx will repair or replace defective luminaires or components at our discretion, provided they have been installed and operated in accordance with our specifications. Other limitations apply, please refer to the full warranty on our website.