

PETITE 1" DOWNLIGHT

ROUND RECESSED ADJUSTABLE

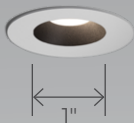

Flanged Trim



Flush Flanged Trim

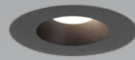

Flanged Trim Cut Cone



Trimless

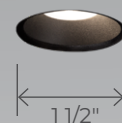

Glow Ring



The Petite family strikes that perfect balance of compact size, streamlined aesthetics, and high performance. Through their 1" lens apertures, these meticulously engineered downlight, cylinder, and multi-aperture luminaires breathe light into spaces with a quiet, straightforward sophistication.

Beam Angles



Light Source



Performance

LUMEN OUTPUT ¹	WATTS	EFFICACY
505 lm	7 W	72 lm/W
667 lm	10 W	67 lm/W
897 lm	14 W	64 lm/W

¹ Lumen packages are assuming 3500K, 90 CRI, 45° beam, trimless, white baffle, and with no lens.

Ceiling Types



Plenum Clearance

As low as 1 3/4"



Petite Family (Refer to other spec sheets) Downlight



Adjustable



Recessed



Wall Wash

Multi-aperture



Adjustable



Recessed



Wall Wash

Cylinder



Pendant



Surface

PETITE 1" DOWNLIGHT

ROUND RECESSED ADJUSTABLE



Project: _____

Type: _____

Order Guide

LUMINAIRE ID ¹	TRIM STYLE	BAFFLE FINISH Specify NA for Glow ring	TRIM FLANGE FINISH Specify NA for Glow ring and Trimless
<p><u>UP TO 15°</u> PETIRRA15 ² - Petite 1" Round Recessed Adjustable</p> <p><u>UP TO 30°</u> PETIRRA30 ³ - Petite 1" Round Recessed Adjustable Cut Cone</p> <p>¹ Recessed (fixed) and Recessed Wall Wash also available. Consult other spec sheets. ² Adjustability: Up to 15° tilt, 355° rotation. ³ Adjustability: Up to 30° tilt, 355° rotation.</p>	<p>PETIRRA15 Adjustable</p> <p>TRM - Flanged trim TRMP - Flush flanged trim drywall mudplate TRMW - Flush flanged trim millwork</p> <p>TLMP - Trimless drywall mudplate TLMW - Trimless millwork</p> <p>GLR - Glow ring</p>	<p>PETIRRA30 Adjustable Cut Cone</p> <p>TRMC - Flanged trim cut cone TRMPC - Flush flanged trim drywall mudplate cut cone TRMWC - Flush flanged trim millwork cut cone</p>	<p>FTMW - Textured matte white FTMB - Textured matte black FSPC - Specular FSSPC - Semi-specular FCHP - Champagne CF# - Custom finish, specify RAL# NA - Not applicable</p>

LENS	CEILING THICKNESS	INSTALLATION TYPE ⁴	MOUNTING OPTION ⁷	LIGHT SOURCE	BEAM
<p>At baffle</p> <p>SDL - Soft diffused lens, Solite NOL - No lens</p>	1IN - Up to 1"	<p>IC ⁵ - Type-IC NIC ⁶ - Type Non-IC CP ⁵ - Chicago Plenum Type-IC (CCEA)</p> <p>⁴ See page 3 for more details. ⁵ Up to 10 W with 90 CRI. ⁶ Up to 14 W with 90 CRI.</p>	<p>ASB - Adjustable standard bar hangers FMB - Flush mount bars ACB - Adjustable commercial bar hangers AHC - Adjustable hat channel bars NA - None</p> <p>⁷ See page 5 for more details.</p>	<p>SW - Static white</p> <p>SOLA - Dim-to-warm single channel control DUO - Tunable white 2-channel control</p>	<p>35DEG - 35° Narrow flood 45DEG - 45° Flood 60DEG ^{8,9} - 60° Wide flood</p> <p>⁸ Only available with TLMP and TLMW trim options. ⁹ Not available with SDL lens option. ¹⁰ Not available with TLMP and TLMW trim options.</p> <p>45DEG ¹⁰ - 45° Flood 60DEG ^{8,9} - 60° Wide flood</p>

COLOR QUALITY	CRI	COLOR TEMP.	DRIVER	VOLTAGE	WATTAGE	DIMMING ¹⁶
<p>2STP - 2 Step MacAdam Ellipse 3STP - 3 Step MacAdam Ellipse</p>	<p>90CRI - 90 CRI 95CRI - 95 CRI 80CRI - 80 CRI</p>	<p>27K - 2700K 30K - 3000K 35K - 3500K 40K - 4000K</p>	<p>INTEGRAL ¹¹</p> <p>¹¹ Access above the ceiling is required. ¹² A remote driver box is provided, see page 4 for details.</p>	<p>120V - 120V 277V - 277V UNV - 120V-277V</p>	<p>7W - 7 W output, up to 505 lm 10W ¹³ - 10 W output, up to 667 lm 14W ^{14,15} - 14 W output, up to 897 lm</p> <p>¹³ Not available with 95 CRI when specified with IC/CP. ¹⁴ Only available with 90 CRI when specified with NIC. ¹⁵ Not available with IC/CP.</p>	<p>D1 - 1% 0-10V ELV ¹⁷ - ELV 120V TRI ¹⁷ - TRIAC 120V ELD1 - eldoLED 1% ECOdrive 0-10V ELDO - eldoLED 0.1% SOLOdrive 0-10V PEQO ¹⁸ - Lutron Hi-lume Premier 0.1% EcoSystem</p> <p>¹⁶ PoE (Power-over-Ethernet) compatible. Consult factory for details. ¹⁷ Available with 120V only. ¹⁸ On-site commissioning is required.</p>
<p>3STP - 3 Step MacAdam Ellipse</p>	90CRI - 90 CRI	<p>SOLA 30K18K - 3000K to 1800K 27K18K - 2700K to 1800K</p> <p>DUO 65K27K - 6500K to 2700K 50K27K - 5000K to 2700K</p>	<p>REMOTE ¹²</p>		<p>SOLA 10W - 10 W output, up to 324 lm 14W ¹⁵ - 14 W output, up to 430 lm</p>	<p>SOLA SD1 - Single 0-10V input SELV ¹⁷ - ELV 120V STRI ¹⁷ - TRIAC 120V</p>
<p>DO NOT SPECIFY FOR REMOTE. SEE "REMOTE DRIVER BOX" SECTION BELOW.</p>						

Remote Driver Box Ordered separately. Specify each required remote driver box on a separate line.

REMOTE DRIVER ¹⁹	LUMINAIRE QTY.	LUMINAIRE ID	VOLTAGE	WATTAGE	DIMMING
<p>RDB# - Remote driver box</p> <p>¹⁹ Specify an RDB number (#) for each required remote driver box.</p>	<p>1X - 1 luminaire 2X ²⁰ - 2 luminaires 3X ²⁰ - 3 luminaires</p> <p>²⁰ Not available with RLDE1 or DUO.</p>	<p><u>UP TO 15°</u> PETIRRA15 ²¹ - Petite 1" Round Recessed Adjustable</p> <p><u>UP TO 30°</u> PETIRRA30 ²² - Petite 1" Round Recessed Adjustable Cut Cone</p> <p>²¹ Adjustability: Up to 15° tilt, 355° rotation. ²² Adjustability: Up to 30° tilt, 355° rotation.</p>	<p>120V - 120V 277V - 277V UNV - 120V-277V 347V ²³ - 347V</p> <p>²³ Available with RD1 driver only. Please consult factory.</p>	<p>7W - 7 W output, up to 505 lm 10W ²⁴ - 10 W output, up to 667 lm 14W ^{25,26} - 14 W output, up to 897 lm</p> <p>²⁴ Available with 90 CRI when specified with IC/CP. ²⁵ Only available with 90 CRI when specified with IC/CP. ²⁶ Not available with IC/CP.</p>	<p>RD1 - 1% 0-10V RELV ²⁷ - ELV 120V RTRI ²⁷ - TRIAC 120V RLDE1 ²⁸ - Lutron Hi-lume 1% Eco RDA ²⁸ - DALI RELD1 - eldoLED 1% ECOdrive 0-10V</p> <p>²⁷ Available with 120V only. ²⁸ On-site commissioning is required. ²⁹ For emergency battery, code will be like the following example: RD1+EB.</p>
				<p>SOLA 10W - 10 W output, up to 324 lm 14W ²⁶ - 14 W output, up to 430 lm</p> <p>DUO 7W - 7 W output, up to 241 lm</p>	<p>SOLA RSD1 - Single 0-10V input RSELV ²⁷ - ELV 120V RSTRI ²⁷ - TRIAC 120V</p> <p>DUO RDMX ²⁸ - DMX DT6 RDDA ²⁸ - DALI DT6 RDDA8 ²⁸ - DALI DT8</p> <p>RELD0 - eldoLED 0.1% SOLOdrive 0-10V RPEQO ²⁸ - Lutron Hi-lume Premier 0.1% EcoSystem +EB ²⁹ - Emergency battery</p> <p>RDD1 - Dual 0-10V input for CCT/intensity RLD2 ²⁸ - Lutron DALI-2 digital</p>

EXAMPLE CODE:	LIGHT	PETIRRA15-TRM-FTMW-FTMW-SDL-1IN-IC-ASB-SW-35DEG-2STP-90CRI-35K-REMOTE	REMOTE DRIVER	RDB1-2X-PETIRRA15-120V-7W-RD1 RDB2-1X-PETIRRA15-120V-7W-RD1
----------------------	--------------	-----------------------------------------------------------------------	----------------------	----------------------------------------------------------------



PETITE 1" DOWNLIGHT

ROUND RECESSED ADJUSTABLE



Installation Types

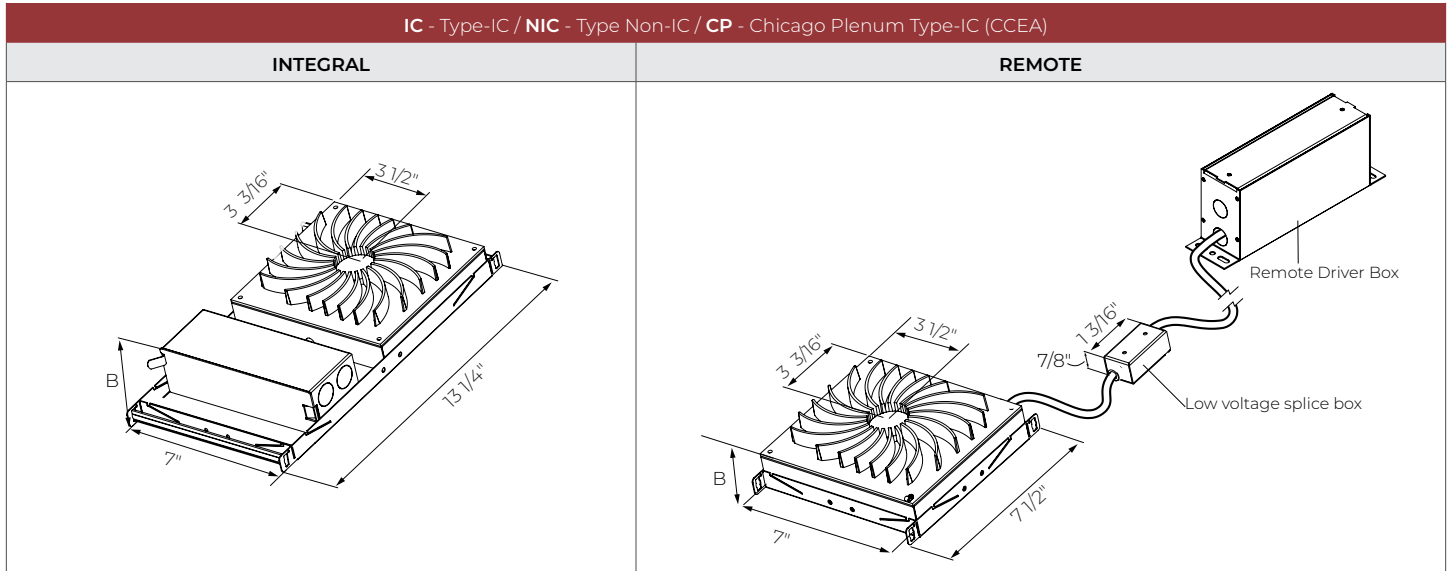

- For integral, access above the ceiling is required.
 - For dimension B, see the PLENUM CLEARANCE table below.

PLENUM CLEARANCE

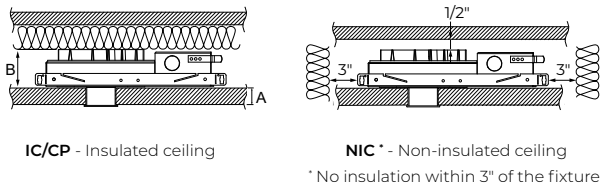

CUT-OUT DIMENSIONS

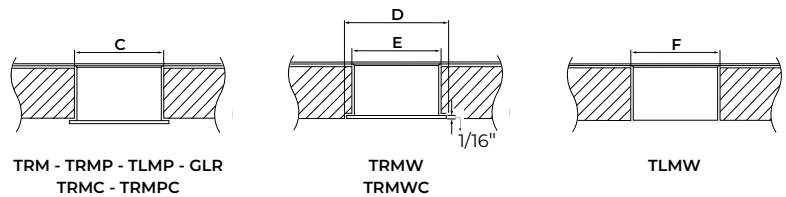

PLENUM CLEARANCE HEIGHT AND CEILING THICKNESS			
		IC/CP	NIC
A	Ceiling Thickness	1IN	1IN
B	Integral Remote	2 1/8" (FMB) 4" (ASB, ACB, AHC)	2 5/8" (FMB) 4" (ASB, ACB, AHC)

	PETIMRRA15 Adjustable	PETIMRRA30 Adjustable Cut Cone	CUT-OUT DIMENSIONS		
			Drywall	Acoustic tile	Millwork
C	TRM	TRMC	Ø 111/16"	N/A	
	TRMP / TLMP	TRMPC	Ø 111/16"	N/A	
	GLR	NA	Ø 111/16"		
D	TRMW	TRMWC	N/A		Ø 113/16"
E			N/A		Ø 111/16" with 1/16" lip
F	TLMW	NA	N/A	Ø 111/16"	



PETITE 1" DOWNLIGHT

ROUND RECESSED ADJUSTABLE



REMOTE DRIVER BOX

RDBCS

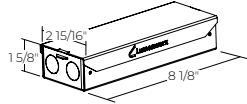

RDBCM

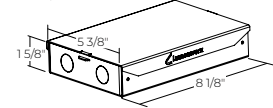

RDBCL

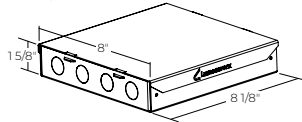

DRIVER	RDB	# DRIVERS
RD1	RDBCS	1X
RSD1	RDBCM	2X
	RDBCL	3X
RELV	RDBCS	1X
RTRI		
RDA		
RELD0		
RELD1		
RPEQ0	RDBCM	2X, 3X
RSELV		
RSTRI		

RDB18 / RDB24

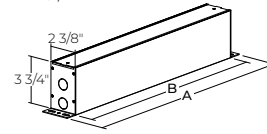

RDB24W

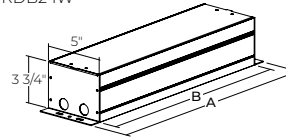

DRIVER	RDB	A	B
RLDE1	RDB18	20"	18"
RDMX	RDB24	26"	24"
RDDA			
RDDA8			
RDD1			
RLD2			
RD1+EB	RDB24W	26"	24"
RELV+EB			
RTRI+EB			
RPEQ0+EB			
RLDE1+EB	RDB24W	26"	24"
RDA+EBI			
RELD1+EB			
RELD0+EB			

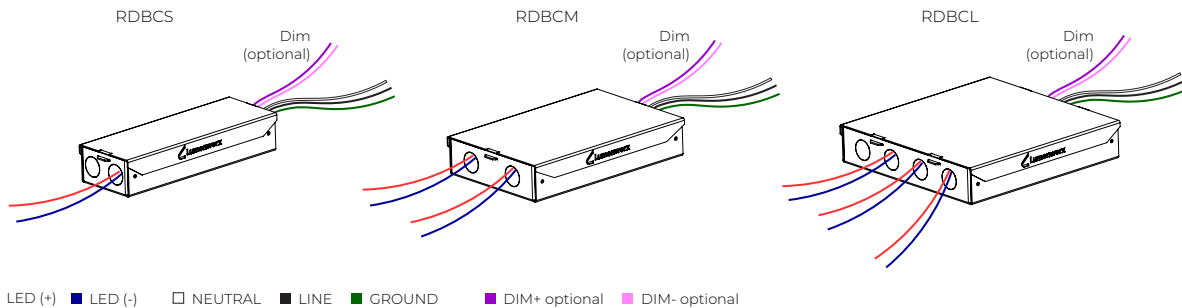

PETITE 1" DOWNLIGHT

ROUND RECESSED ADJUSTABLE



Mounting Options

ASB - Adjustable Standard Bar Hangers

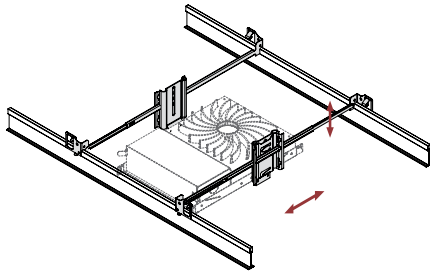

Adjustable Standard Bar hangers can be used in both commercial and residential applications and are adjustable to various heights in both Grid Ceiling and Drywall mounting. ASB hangers are less rigid and versatile than ACB hangers.

FMB - Flush Mount Bars

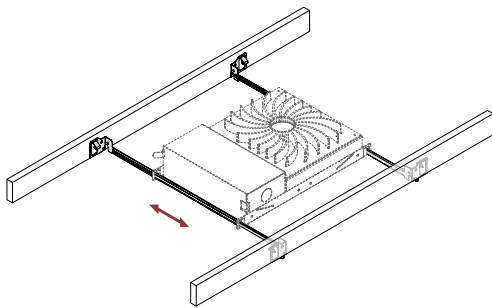

Flush Mount Bars are best used in residential applications, fitting snug to the surface and suitable for Wood, Metal, and Drywall mounting. The flush mounted bars are static and can't be adjusted.

ACB - Adjustable Commercial Bar Hangers

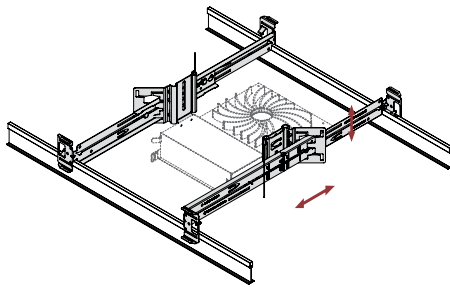

Adjustable Commercial Bar hangers can be used in both commercial and residential applications and are by far the most versatile mounting bar we offer with its adjustability to various heights. ACB hangers are suitable for Grid Ceiling, Drywall, Metal, Wood and Frame mounting.

- Extremely rigid
- Fits into C-Channel notches in a Butterfly Bracket

AHC - Adjustable Hat Channel Bars

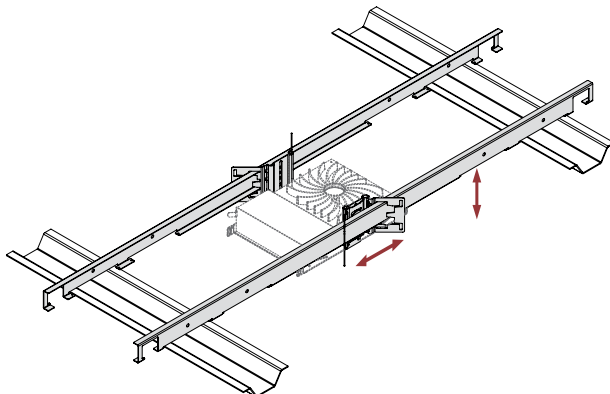

Adjustable Hat Channel bars can be used in both commercial and residential applications and come with a butterfly clip to adjust to various heights. AHC bars can be hung downward by 90 degrees in vertical position, and once wired, can be shifted onto the horizontal mounting plane. AHC bars are suitable for both Drywall and wood ceiling applications.

PETITE 1" DOWNLIGHT

ROUND RECESSED ADJUSTABLE



Trim Style

RECESSED ADJUSTABLE

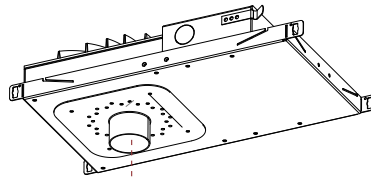

Lens

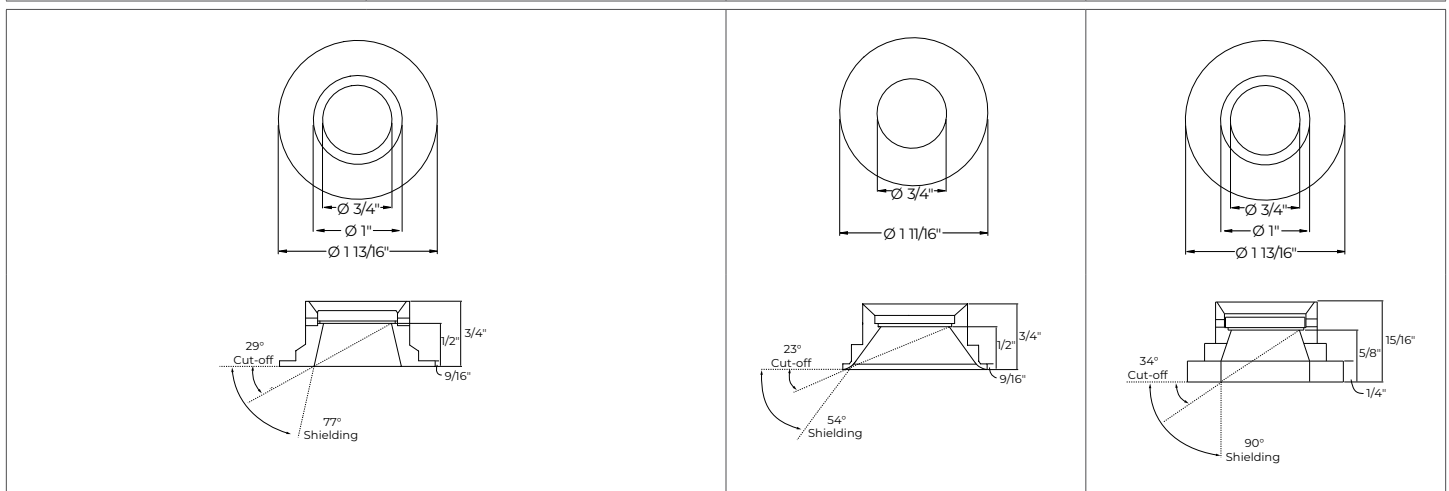
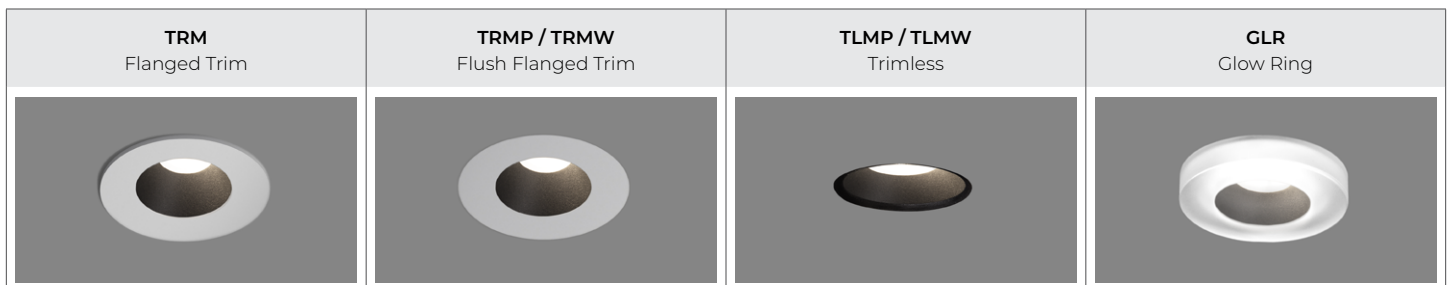
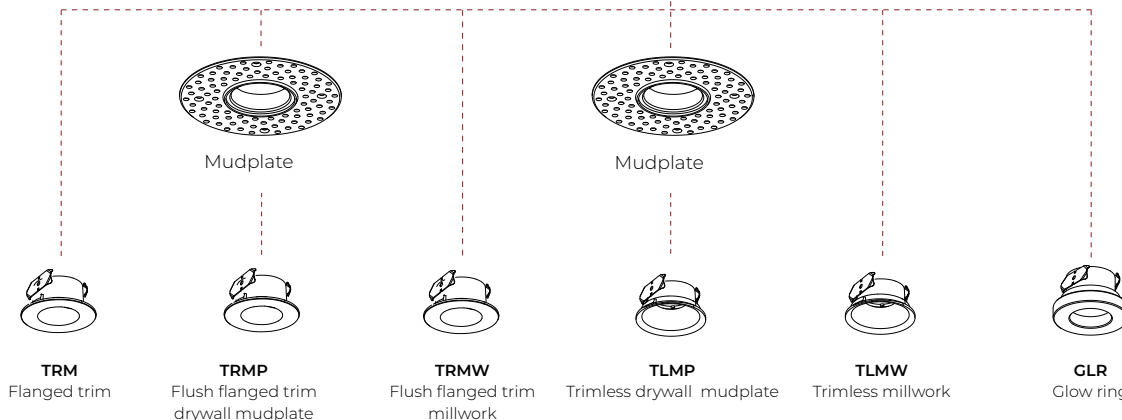
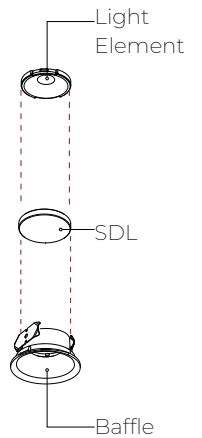

PETITE 1" DOWNLIGHT

ROUND RECESSED ADJUSTABLE



Trim Style

RECESSED ADJUSTABLE CUT CONE

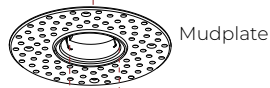
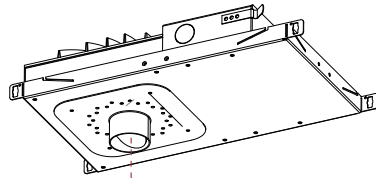

TRMC
Flanged trim cut cone



TRMPC
Flush flanged trim drywall
mudplate cut cone

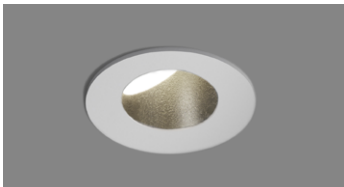
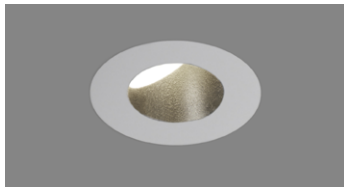

TRMWC
Flush flanged trim
millwork cut cone

TRMC Flanged Trim Cut Cone	TRMPC / TRMWC Flush Flanged Trim Cut Cone
	

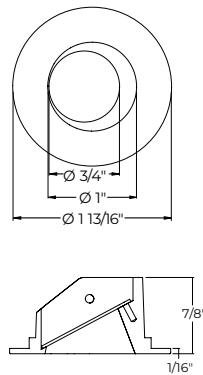

PETITE 1" DOWNLIGHT

ROUND RECESSED ADJUSTABLE



Color Quality

COLOR QUALITY - 3500K	
TM-30 R _r	91
TM-30 R _g	100
CRI	90
R9	> 50

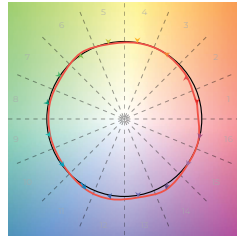

Photometrics

STATIC WHITE - ADJUSTABLE

Values calculated based on 3500K, 90 CRI, and with no lens. The light distribution will vary depending on baffle finish and trim style.

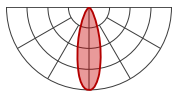

35DEG - 35° Narrow flood

WATTAGE		7 W		10 W		14 W	
Trim style	Baffle finish	lm	lm/W	lm	lm/W	lm	lm/W
Trim	White	425	61	529	53	712	51
	Black, Champagne	327	47	432	43	581	41
	Specular, Semi-specular	382	55	505	50	679	49
Trimless	White	449	64	592	59	797	57
	Black, Champagne	413	59	545	55	734	52
	Specular, Semi-specular	283	40	589	59	793	57
Glow ring		406	58	535	53	720	51

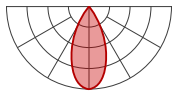

45DEG - 45° Flood

WATTAGE		7 W		10 W		14 W	
Trim style	Baffle finish	lm	lm/W	lm	lm/W	lm	lm/W
Trim	White	425	61	561	56	755	54
	Black, Champagne	344	49	454	45	611	44
	Specular, Semi-specular	407	58	538	54	724	52
Trimless	White	505	72	667	67	897	64
	Black, Champagne	436	62	575	57	774	55
	Specular, Semi-specular	481	69	634	63	854	61
Glow ring		408	58	539	54	725	52

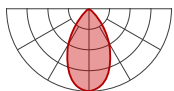

60DEG - 60° Wide flood

WATTAGE		7 W		10 W		14 W	
Trim style	Baffle finish	lm	lm/W	lm	lm/W	lm	lm/W
Trimless	White	318	45	419	42	564	40
	Black, Champagne	247	35	326	33	439	31
	Specular, Semi-specular	283	40	373	37	502	36

MULTIPLIERS

Please follow the multiplier tables to ensure correct lumen value. CCT, CRI, and lensing will change the lumen value.

CCT		CRI		LENS	
2700K	0.91	80 CRI	1	SDL-Soft diffused lens, Solite	0.91
3000K	0.96	90 CRI	1	No lens	1
3500K	1	95 CRI	0.77		
4000K	1.01				



PETITE 1" DOWNLIGHT

ROUND RECESSED ADJUSTABLE



Photometrics

SOLA/DUO - ADJUSTABLE

Values calculated based on with no lens. The light distribution will vary depending on baffle finish and trim style.

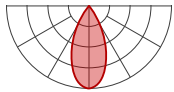

45DEG - 45° Flood

SOLA

WATTAGE			10 W		14 W	
CCT	Trim style	Baffle finish	lm	lm/W	lm	lm/W
3000K	Trim	White	273	27	359	26
		Black, Champagne	221	22	293	21
		Specular, Semi-specular	262	26	348	25
	Glow ring	262	26	348	25	
2700K	Trim	White	273	27	359	26
		Black, Champagne	221	22	293	21
		Specular, Semi-specular	262	26	348	25
	Glow ring	262	26	348	25	

DUO

WATTAGE			7 W	
CCT	Trim style	Baffle finish	lm	lm/W
6000K	Trim	White	160	23
		Black, Champagne	125	18
		Specular, Semi-specular	140	20
Glow ring	162	23		
5000K	Trim	White	160	23
		Black, Champagne	125	18
		Specular, Semi-specular	140	20
Glow ring	162	23		
2700K	Trim	White	140	20
		Black, Champagne	109	16
		Specular, Semi-specular	122	17
Glow ring	134	19		

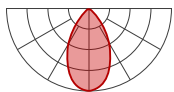

60DEG - 60° Wide flood

SOLA

WATTAGE			10 W		14 W	
CCT	Trim style	Baffle finish	lm	lm/W	lm	lm/W
3000K	Trimless	White	324	32	430	31
		Black, Champagne	262	26	348	25
		Specular, Semi-specular	310	31	412	29
2700K	Trimless	White	324	32	430	31
		Black, Champagne	262	26	348	25
		Specular, Semi-specular	310	31	412	29

DUO

WATTAGE			7 W	
CCT	Trim style	Baffle finish	lm	lm/W
6000K	Trimless	White	190	27
		Black, Champagne	148	21
		Specular, Semi-specular	166	24
5000K	Trimless	White	190	27
		Black, Champagne	148	21
		Specular, Semi-specular	166	24
2700K	Trimless	White	166	24
		Black, Champagne	129	18
		Specular, Semi-specular	145	21

MULTIPLIERS

Please follow the multiplier table to ensure correct lumen value. Lensing will change the lumen value.

LENS

SDL-Soft diffused lens, Solite	0.91
NOL - No lens	1

PETITE 1" DOWNLIGHT

ROUND RECESSED ADJUSTABLE



Photometrics

STATIC WHITE - ADJUSTABLE CUT CONE

Values calculated based on 3500K, 90 CRI, and with no lens. The light distribution will vary depending on baffle finish and trim style.

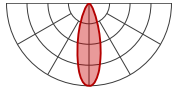

35DEG - 35° Narrow flood

WATTAGE		7 W		10 W		14 W	
Trim style	Baffle finish	lm	lm/W	lm	lm/W	lm	lm/W
Trim	White	359	51	512	51	717	51
	Black, Champagne	330	47	472	47	661	47
	Specular, Semi-specular	357	51	509	51	713	51

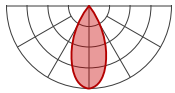

45DEG - 45° Flood

WATTAGE		7 W		10 W		14 W	
Trim style	Baffle finish	lm	lm/W	lm	lm/W	lm	lm/W
Trim	White	409	58	584	58	818	58
	Black, Champagne	353	50	504	50	705	50
	Specular, Semi-specular	389	56	556	56	778	56

MULTIPLIERS

Please follow the multiplier tables to ensure correct lumen value. CCT, CRI, and lensing will change the lumen value.

CCT		CRI		LENS	
2700K	0.91	80 CRI	1	SDL-Soft diffused lens, Solite	0.91
3000K	0.96	90 CRI	1	No lens	1
3500K	1	95 CRI	0.77		
4000K	1.01				

SOLA/DUO - ADJUSTABLE CUT CONE

Values calculated based on with no lens. The light distribution will vary depending on baffle finish and trim style.

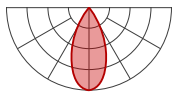

45DEG - 45° Flood

SOLA

WATTAGE			10 W		14 W	
CCT	Trim style	Baffle finish	lm	lm/W	lm	lm/W
3000K	Trim	White	285	29	379	27
		Black, Champagne	222	22	295	21
		Specular, Semi-specular	249	25	331	24
2700K	Trim	White	285	29	379	27
		Black, Champagne	222	22	295	21
		Specular, Semi-specular	249	25	331	24

DUO

WATTAGE				7 W	
CCT	Trim style	Baffle finish	lm	lm/W	lm/W
6000K	Trim	White	241	34	
		Black, Champagne	187	27	
		Specular, Semi-specular	210	30	
5000K	Trim	White	241	34	
		Black, Champagne	187	27	
		Specular, Semi-specular	210	30	
2700K	Trim	White	211	30	
		Black, Champagne	164	23	
		Specular, Semi-specular	185	26	

MULTIPLIERS

Please follow the multiplier table to ensure correct lumen value. Lensing will change the lumen value.

LENS	
SDL-Soft diffused lens, Solite	0.91
NOL - No lens	1



PETITE 1" DOWNLIGHT

ROUND RECESSED ADJUSTABLE



Technical Specifications

OPTIC

The CircaFlex™ Optic uses advanced beam-splitting technology to allow light to follow an intended optical path with maximal precision, minimal spread, and even distribution.

LIGHT SOURCE

Static white

Compact COB (Chip-On-Board) LED module, available in 2700K, 3000K, 3500K and 4000K with a choice of 80 CRI, 90 CRI, or 95 CRI, with elevated R9 value for 90 CRI and above. Color consistency is maintained to within 2 SDCM. All LEDs have been tested in accordance with IESNA LM-80-08 and the results have shown L80 lumen maintenance greater than 60,000 hours. Absolute product photometry is measured and presented in accordance with IESNA LM-79, unless otherwise indicated.

Chromawerx SOLA

Chromawerx SOLA is single-channel control that dims output while warming the color temperature in a pre-determined relationship. Two color temperature range options are offered: 3000K to 1800K, and 2700K to 1800K. A simple analog control adjusts a specially populated LED array to emulate the effect of dimming a filament source.

Chromawerx DUO

Chromawerx DUO offers a two-channel control system which uses analog or digital protocols for synchronous control of both cool to warm LED arrays - maintaining a CRI above 90. Two color temperature range options are offered: 6500K to 2700K, and 5000K to 2700K. The range of color DUO offers is useful for entraining circadian rhythms, stimulating alertness, and compensating for jet lag among other applications. The Chromawerx drivers are programmed to limit maximum light output and power usage across all color temperatures. When paired with DALI drivers (DDA/DDA8), color tuning follows a linear dimming curve.

ELECTRICAL

Unless otherwise specified, dimming down to 1%. At maximum driver load: efficiency > 84%, PF > 0.9, THD < 20%.

Integral: 0-10V, ELV, TRIAC, eldoLED 1% ECOdrive 0-10V, eldoLED 0.1% SOLOdrive 0-10V, Lutron Hi-lume Premier 0.1% EcoSystem

Remote: 0-10V, ELV, TRIAC, Lutron Hi-lume 1% Eco, DALI, eldoLED 1% ECOdrive 0-10V, eldoLED 0.1% SOLOdrive 0-10V, Lutron Hi-lume Premier 0.1% EcoSystem, DMX, Lutron DALI-2 digital

Emergency battery option: Remotely-installed, long-life, high-temperature, maintenance-free, Bodine Lithium-Ion battery pack with self-test functionality, test switch and charge indicator. IOTA and Fulham options available upon request. Minimum of 90 minutes operation, and recharge time of 24 hours. For fixtures less than 10 W, the battery provides 6 W of emergency light output. For fixtures 10 W and over, the battery provides 10 W.

PoE: Depending on the PoE manufacturer selected, Lumenwerx will install the node in factory as either integral to the luminaire or as a remote module. Factory programming of the PoE node may or may not enable the following functionalities: lumen package, DUO (tunable white), QUADRO (RGBW), emergency battery backup, and sensor integration. These must be addressed and evaluated on a case-by-case basis.

CONSTRUCTION

Housing: For new construction, 20 gauge powder coated steel. 18 gauge galvanized steel junction box with ½" trade size knockouts. Adjustable hanger bars and butterfly brackets are included.

Adjustable commercial hat channel and flush mounted brackets are also available.

Baffle: Die-cast aluminum mounted with retaining spring clips

Glow ring: Acrylic

Heat sink: Die-cast aluminum

WEIGHT

Integral: 4 lbs - 1.8 kg

Remote: 2.1 lbs. - 0.95 kg

LENS



Soft diffused lens, Solite

ENVIRONMENT

Ambient temperature at fixture location shall be within 0°C/32°F - 25°C/77°F, indoor dry or damp as well as outdoor damp use (canopies or marquees).

CERTIFICATIONS

ETL: Rated for indoor dry/damp locations. Conforms to UL Standard 1598 and certified to CAN/CSA Standard C22.2 No. 250.0.

Chicago Plenum: City of Chicago approved (CCEA) when specified with CP installation type option.

IC rated: Suitable for direct contact with insulation when specified with IC or CP installation type options.

WARRANTY

Lumenwerx provides a five-year limited warranty on electrical and mechanical performance of the luminaires, including the LED boards, drivers, and auxiliary electronics. Lumenwerx will repair or replace defective luminaires or components at our discretion, provided they have been installed and operated in accordance with our specifications. Other limitations apply, please refer to the full warranty on our website.