

QUAD NARROW

WALL

LUMENWERX
WWW.LUMENWERX.COM

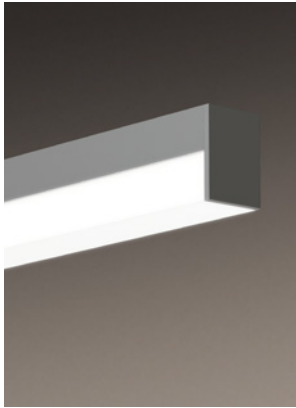

Quad narrow



Quad narrow round

DESCRIPTION

Crisp, clean lines and modern silhouettes meet flexibility and power in Quad, a compact family of luminaires suitable for various ambient, task, and accent lighting requirements. Fitted with our High-Efficiency Lambertian Optic (HLO), Quad delivers excellent luminous efficacy and uniform luminosity. Available in three shapes—curved, rectangle, and square—and three mounting options—pendant, surface, and wall—Quad offers a full range of source technology while featuring a variety of control solutions.

PROJECT: _____

TYPE: _____

NOTES: _____

ORDER GUIDE

up to 143 lm/W performance



LUMINAIRE ID	OPTICS	LIGHT SOURCE	CRI	LUMEN PACKAGES	COLOR TEMP.
QUANW - Quad narrow wall QUANRW - Quad narrow round wall	HLO - High-Efficiency Lambertian Optic	SW - Static white FS - Full spectrum BIOSSST - Static biologically-optimized lighting BIOSDY - Dynamic biologically-optimized lighting	80 ¹ - 80CRI 90 ^{1,2} - 90CRI 95 ³ - 95CRI ¹ Not available with full spectrum. ² Not available with BIOS. ³ Only available with full spectrum.	550 - min. low output 550lm/ft 750 - medium output 750lm/ft 1000 ⁴ - max. high output 1000lm/ft #### - other required lm/ft ⁴ Not available with full spectrum or BIOS.	27 - 2700K 30 - 3000K 35 - 3500K 40 - 4000K

LUMINAIRE LENGTH	VOLTAGE	DRIVER	ELECTRICAL	MOUNTING
Standard sections - 4' 8" & 12' For all other specify length #FT - nominal length in feet Continuous Run - for luminaires over 8'	120 - 120V 277 - 277V UNV - 120V-277V 347 ⁵ - 347V ⁵ Only available with D1 driver.	D1 - 1% 0-10V DA ⁶ - DALI LTEA2W - Lutron 1% - 2 wire FP 120V LDE1 ⁶ - Lutron Hi-lume 1% Eco ⁶ On-site commissioning is required.	1 - 1 circuit +EB ⁷ - emergency battery +EM - emergency light circuit +NL - night light circuit +GTD ⁸ - generator transfer device ⁷ Minimum 4' fixture. ⁸ Not available with 347V.	DRM - drywall mounting DMB - drywall mounting bracket

FINISH	CONTROLS	OPTIONS
W - matte white AL - aluminum CF# - custom finish, specify RAL#	STANDALONE CONTROLS OMS - Onboard Occupancy ODS - Onboard Daylight OCS - Onboard Occupancy & Daylight CONNECTED CONTROLS CCS() - LU -Lutron, EN -Enlighted, OS -Osram To specify see information on page 3	FU120 - Fuse 120V FU277 - Fuse 277V NA - None

CROSS SECTION

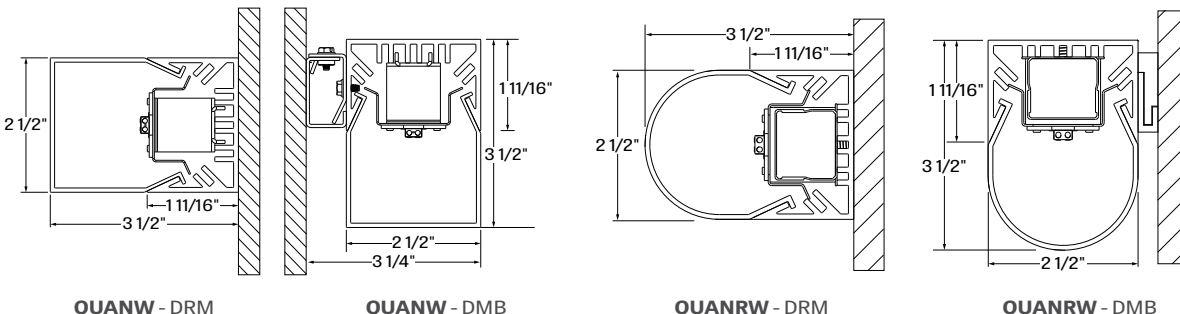

OPTICS

HIGH-EFFICIENCY LAMBERTIAN OPTIC (HLO) - Matte white side reflectors combined with High-Efficiency Lambertian Optic (HLO) shielding of diffusing 0.075" thick acrylic with up to 88% transmission and good source obscuration. Luminaire brightness is controlled by the flux-to-shielding area ratio.

LIGHT SOURCE - LED

Custom linear array of mid-flux LEDs are cartridge-mounted with quick-connect wiring to facilitate service and thermal management. Available in 2700K, 3000K, 3500K and 4000K with a minimum 80 CRI and an option for 90 CRI with elevated R9 value. Color consistency maintained to within 3 SDCM. LEDs operated at reduced drive current to optimize efficacy and lumen maintenance.

All LEDs have been tested in accordance with IESNA LM-80-08 and the results have shown L80 lumen maintenance greater than 60,000 hours. Absolute product photometry is measured and presented in accordance with IESNA LM-79, unless otherwise indicated.

PERFORMANCE PER 4' AT 4000K

LED output	Color Temp	Watts	Nominal Delivered Lumens	Efficacy LPW
low output	4000K	15.38	2200	143
medium output	4000K	24.45	3000	140
high output	4000K	29.44	4000	136



BIOS SkyBlue™ Technology is designed to provide the specific circadian stimulus to improve overall sleep quality, recovery during the night, and overall feelings of well-being.

The non-visual light signals that stimulate our circadian system have peak intensity in the "sky blue" region. As the diagram below illustrates, BIOS SkyBlue technology shifts the peak LED spectral intensity (490 nm) to align better with the peak response of circadian stimulus. Also note the enhanced deep-red (near 660 nm) spectrum.

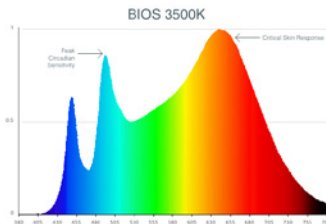

WELL for Light - The WELL building standard focuses on light quality in several features. There are three categories that are fully attributed to the construction and features of a luminaire. In WELL V1, it's Feature 54 Circadian Lighting, Feature 55 Glare Control, and Feature 58 Color Quality. In WELL V2, it's Feature L03 Circadian Lighting, Feature L04 Glare Control, and Feature L07 Electric Light Quality.

This fixture meets Features:

- Feature 54 or L03 when BIOS or full spectrum LED is selected
- Feature 58 or L07 when 90CRI or above is selected

All LED drivers used at Lumenwerx are deemed to have a low risk level of flicker, of 5 % or less below 90Hz operational as defined by IEEE standard 1789-2015 LED.



WELL for Mind - This luminaire meets WELL for mind as it is a human centric luminaire offering quality light, excellent color, and smooth optics. If any of these features are incorporated in a luminaire, it can improve the ability to focus, concentrate, and persist longer on a given task. This fixture harmoniously operates in a space to assist the mind.

For more information, please contact well@lumenwerx.com

QUAD NARROW

WALL

LUMENWERX
WWW.LUMENWERX.COM

LUMINAIRE LENGTH

Quad is made up of standard 4, 8 and 12 foot sections that may be joined together to create longer continuous run lengths. Exact run length must be noted in the product code.

All individual sections are joined together onsite using the joiner kits provided. Lumenwerx offers joiner kits that are extremely simple to work with in the field and result in a fixture that appears virtually seamless with no light leak at any connection.

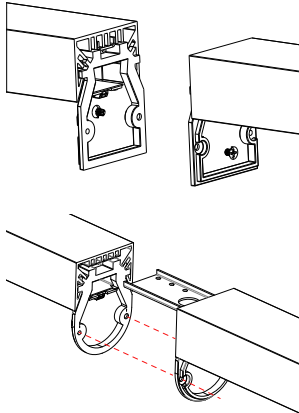

ELECTRICAL

Factory-set, adjustable output current LED driver with universal (120-277VAC) input. Dimmable from 100% to 1% with 0-10V dimming control. Rated life (90% survivorship) of 50,000 hours at 50°C max. ambient (and 70°C max. case) temperature. At maximum driver load: Efficiency > 84%, PF > 0.9, THD < 20%. Other specifiable options include Lutron Hi-Lume 1% (specify 2-wire, or Ecosystem Dim-to-Off), and DALI protocol drivers. All of our standard 0-10V drivers are NEMA 410 compliant.

EMERGENCY

Factory installed long life, high temperature, maintenance-free Lithium-Ion battery pack with self-test functionality, test switch and charge indicator. Minimum of 90 minutes operation, up to 10W (25°C) emergency lighting output and recharge time of 24 hours.

MOUNTING OPTIONS

Fixtures may be horizontally mounted to the wall using a bracket. For long runs, a minimum of 6" from adjacent walls is required.

FINISH

Interior - 95%, reflective matte powder coated white paint

Exterior - matte white or aluminum powder coating.

Custom finishes are also available.

CONTROLS

Lumenwerx offers several options for integrating occupancy and daylight harvesting controls in our luminaires.

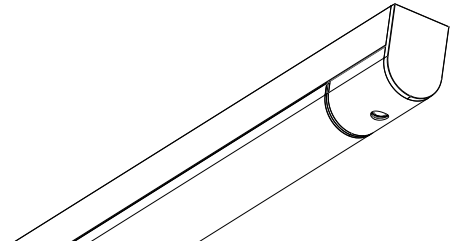

STANDALONE CONTROLS

An integrated standalone sensor controls the luminaire in which it is installed. Depending on the length, more than one sensor may be necessary and may control the entire luminaire, or just a section of it. These controls operate independently. Unless otherwise agreed, location and functionality of the sensor within the luminaire are selected by Lumenwerx.

Three types are available:

OMS: An integral Passive InfraRed (PIR) sensor turns luminaires on and off automatically with field-adjustable time out period. No wall control is used. Coverage pattern for large motion has a 12' diameter with the sensor mounted 8' above the floor; for small motion, the pattern has an 8' diameter. Typically, one sensor is required for every 10' of a continuous luminaire run.

ODS: An integral, daylight harvesting sensor with closed-loop operation dims the luminaire in which it is installed in order to compensate for available daylight. The sensor measures the combination of daylight and luminaire light reflected from horizontal surfaces below the luminaire. Initial onsite calibration is required via the use of provided remote control.

OCS: Both an occupancy and a daylight sensor are installed in the luminaire.

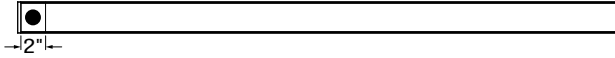

Location of an Onboard control

CONNECTED CONTROLS

With Connected Controls, sensors or nodes installed in the luminaire form part of a larger control system infrastructure from manufacturers such as: Lutron*, Enlited, Osram ENCELIUM, Acuity nLight, and others. These connected controls allow for a scalable system providing features like occupancy and daylight control, manual control, scheduling and configuration of various zones and scenes. Energy reporting and system monitoring are also possible. Specific capabilities depend on the control system being used.

Lumenwerx installs the components (sensors, nodes, power packs, etc) which may be supplied to us by a third party, or procured directly by Lumenwerx, depending on the control system manufacturer.

Lumenwerx is solely responsible for the installation of specified components; the controls manufacturer is responsible for performance of the control system.

To indicate a Lumenwerx luminaire with Connected Controls, identify the specific onsite control system to be integrated into the luminaires using the ordering code. Due to the diversity of components, you must contact controls@lumenwerx.com to assure complete compatibility with intended control system and to fully specify the luminaire.

Complete control specifications, sensor/node/power pack layout, and narrative for the control system are required for Lumenwerx to create shop drawings and submittals.

* Lumenwerx offers a Lutron Vive-Enabled fixture option using either the DFCSJ-OEM-OCC (OCS Option) or DFCSJ-OEM-RF (wireless only, no sensor) Integral Fixture Modules and a DALI or EcoSystem LED driver based on customer dimming requirements.

Please contact our controls department at controls@lumenwerx.com for further assistance.

CONSTRUCTION

Housing - Extruded aluminum (0.085" nominal) up to 90% recycled content

Interior brackets - Die formed cold rolled sheet steel 20 gauge thick

Joining system - Die cast aluminum (0.85" nominal)

Reflectors - Flat rolled aluminum sheet 0.040" thick precisely die formed, 95% reflective matte white painted

End caps - Die cast aluminum (0.85" nominal)

WEIGHT

Quad narrow 4ft - 8.48lbs - 3.85kg

Quad narrow 8ft - 17.07lbs - 7.75kg

Quad narrow 12ft - 25.33lbs - 11.5kg

CERTIFICATIONS

ETL - Rated for Indoor Dry/Damp locations. Conforms to UL Standard 1598 and certified to CAN/CSA Standard C22.2 No. 250.0.

WARRANTY

Lumenwerx provides a five-year limited warranty of electrical and mechanical performance of the luminaires, including the LED boards, drivers, and auxiliary electronics. Lumenwerx will repair or replace defective luminaires or components at our discretion, provided they have been installed and operated in accordance with our specifications. Other limitations apply, please refer to the full warranty on our website.

QUAD NARROW

WALL

LUMENWERX
WWW.LUMENWERX.COM

PERFORMANCE FOR QUAD NARROW

550 LUMEN AT 80CRI - LOW OUTPUT

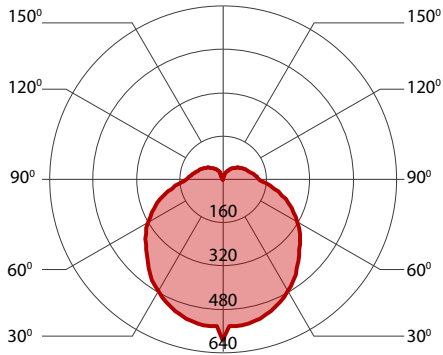

PERFORMANCE PER 4'

LED output	Color Temp	Watts	Nominal Delivered Lumens	Efficacy LPW
low output	2700K	16.32	2200	135
low output	3000K	15.84	2200	139
low output	3500K	15.43	2200	143
low output	4000K	15.38	2200	143

750 LUMEN AT 80CRI - MEDIUM OUTPUT

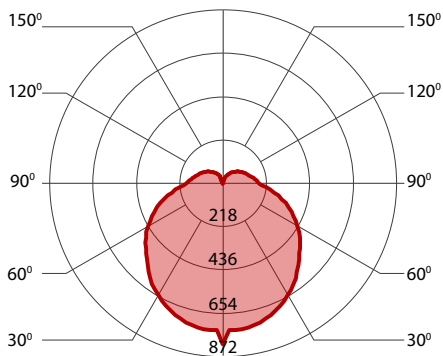

PERFORMANCE PER 4'

LED output	Color Temp	Watts	Nominal Delivered Lumens	Efficacy LPW
medium output	2700K	22.77	3000	132
medium output	3000K	22.1	3000	136
medium output	3500K	21.51	3000	139
medium output	4000K	21.45	3000	140

1000 LUMEN AT 80CRI - HIGH OUTPUT

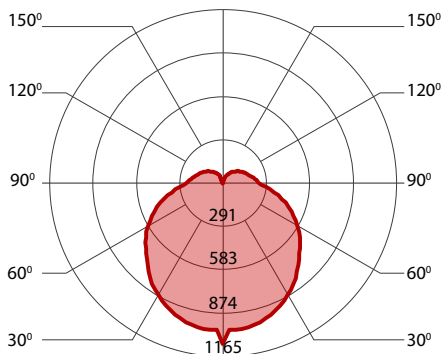

PERFORMANCE PER 4'

LED output	Color Temp	Watts	Nominal Delivered Lumens	Efficacy LPW
high output	2700K	31.28	4000	128
high output	3000K	30.23	4000	132
high output	3500K	29.53	4000	135
high output	4000K	29.44	4000	136

QUAD NARROW

WALL

LUMENWERX
WWW.LUMENWERX.COM

PERFORMANCE FOR QUAD NARROW ROUND

550 LUMEN AT 80CRI - LOW OUTPUT

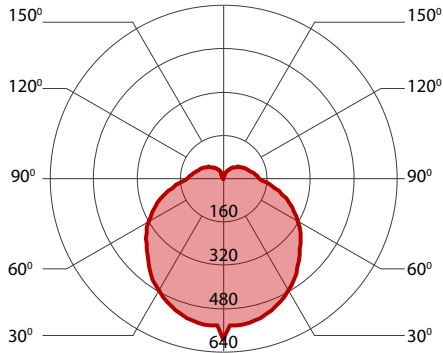

PERFORMANCE PER 4'

LED output	Color Temp	Watts	Nominal Delivered Lumens	Efficacy LPW
low output	2700K	16.32	2200	135
low output	3000K	15.84	2200	139
low output	3500K	15.43	2200	143
low output	4000K	15.38	2200	143

750 LUMEN AT 80CRI - MEDIUM OUTPUT

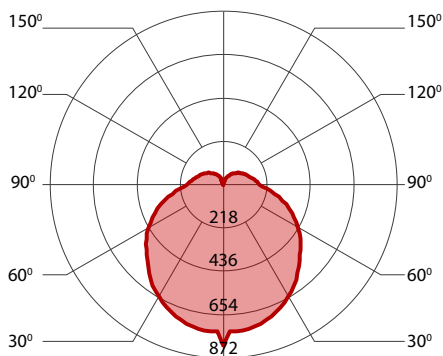

PERFORMANCE PER 4'

LED output	Color Temp	Watts	Nominal Delivered Lumens	Efficacy LPW
medium output	2700K	22.77	3000	132
medium output	3000K	22.1	3000	136
medium output	3500K	21.51	3000	139
medium output	4000K	21.45	3000	140

1000 LUMEN AT 80CRI - HIGH OUTPUT

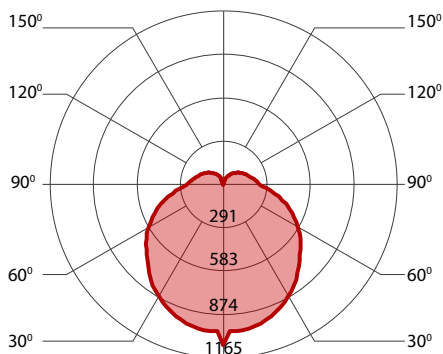

PERFORMANCE PER 4'

LED output	Color Temp	Watts	Nominal Delivered Lumens	Efficacy LPW
high output	2700K	31.28	4000	128
high output	3000K	30.23	4000	132
high output	3500K	29.53	4000	135
high output	4000K	29.44	4000	136