

SHALO ULTRA 3 PATTERN

RECESSED

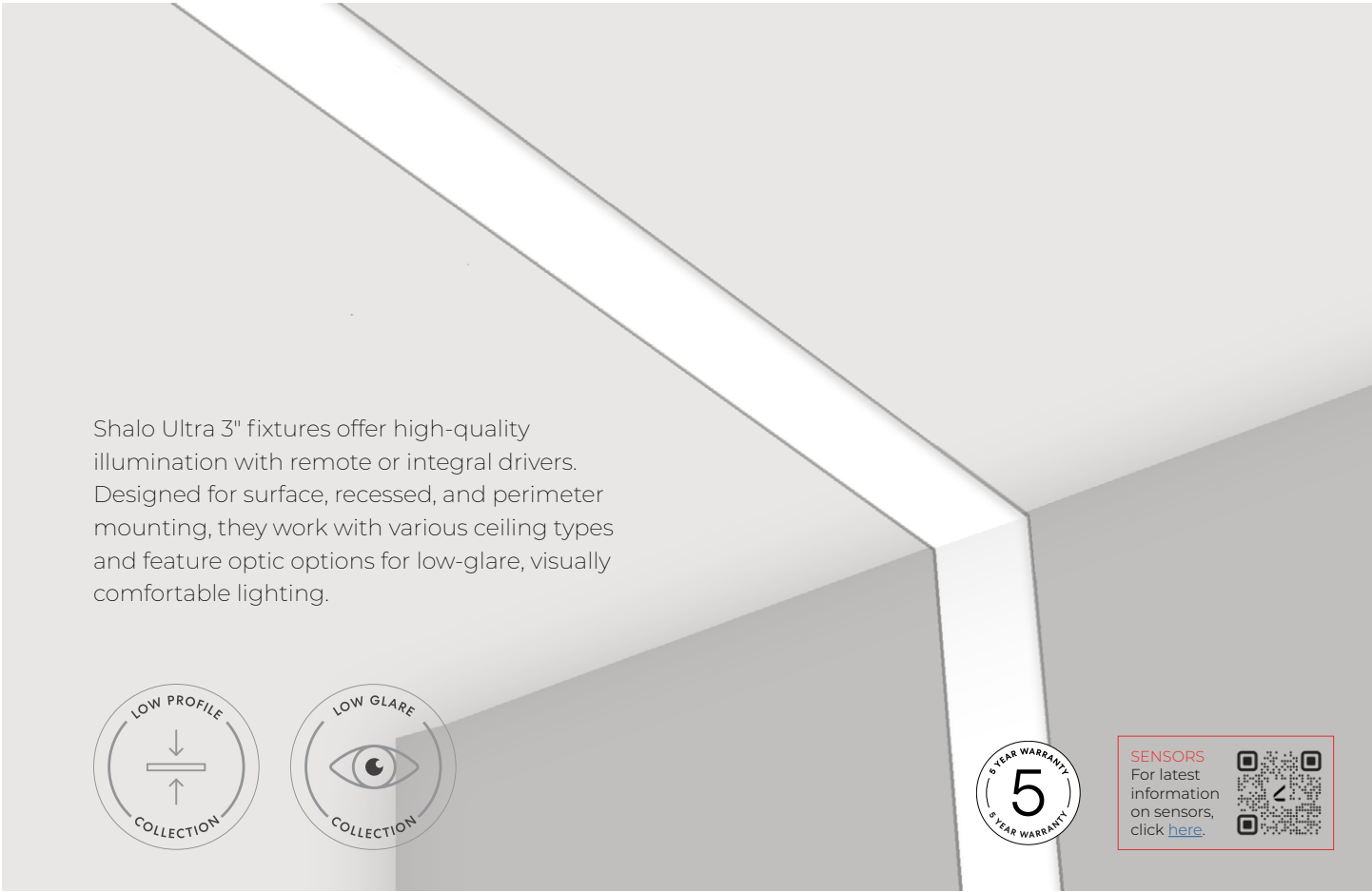

Shalo Ultra 3" fixtures offer high-quality illumination with remote or integral drivers. Designed for surface, recessed, and perimeter mounting, they work with various ceiling types and feature optic options for low-glare, visually comfortable lighting.



SENSORS
For latest information on sensors, click [here](#).

Grid



Drywall

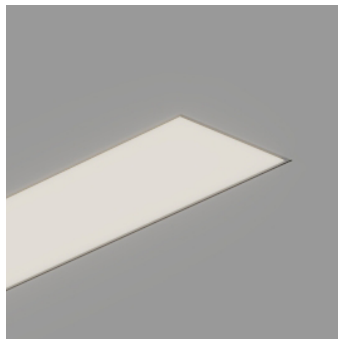

Wood



Multiple flange (Drywall/Grid)



SHALO ULTRA 3 PATTERN

RECESSED



Project: _____

Type: _____

Order Guide

IC RATED

A drawing of your pattern is required - anything from a line drawing to an architectural drawing.

LUMINAIRE ID	DISTRIB.	DRIVER LOCATION	OPTIC	LIGHT SOURCE	CRI	LUMEN PACKAGE
SHLU3RPAT	D			SW		
SHLU3RPAT - Shalo Ultra 3" Recessed Pattern	D - Direct	INTEGRAL ¹ - Integral driver REMOTE ² - Remote driver ¹ Fixture height is 2 1/8". ² Fixture height is 1 3/16".	SLO - Shallow Lambertian optic SMPO - Shallow Micro-Prismatic Optic	SW - Static white	80CRI - 80+ CRI 90CRI - 90+ CRI	250LMF - Hypo output 250 lm/ft 350LMF - Low output 350 lm/ft 500LMF - Medium output 500 lm/ft 750LMF - High output 750 lm/ft 1000LMF - Hyper output 1000 lm/ft

COLOR TEMP.	PATTERN LENGTH	CORNER TYPE ^{4,5,6}	VOLTAGE	DRIVER
27K - 2700K 30K - 3000K 35K - 3500K 40K - 4000K 50K - 5000K	##FT##IN(##X##FT##IN-##X##FT##IN-...) ³ - ##FT##IN: total nominal length of pattern in feet and/or inches #X: quantity of each section ##FT##IN: nominal length of each section in feet and/or inches Continuous runs: lengths over 8' ³ Minimum 2'.	#LEV2C(A90) - 2-way leveled corner #INN2C(A90) - 2-way inner corner ⁴ See page 5 for details. Corner angle is 90°. ⁵ Specify quantity (#) for each required corner type. ⁶ If more than one option is specified, separate codes with a "+", e.g. 2LEV2C(A90)+1INN2C(A90).	120V - 120V 277V - 277V UNV - 120V-277V 347V ⁷ - 347V ⁷ Available with DI or RD1 driver only.	INTEGRAL D1 - 1% 0-10V ELV ⁸ - ELV 120V TRI ⁸ - TRIAC 120V DA ⁹ - DALI LDE1 ⁹ - Lutron Hi-Lume 1% Eco ELD1 - eldoLED 1% ECOdrive 0-10V ELD0 - eldoLED 0.1% SOLOdrive 0-10V ⁸ Available with 120V only. ⁹ On-site commissioning is required. ¹⁰ A remote driver box is provided.

ELECTRICAL	ELECTRICAL SECTION ^{14,15}	MOUNTING CEILING ²⁰	MOUNTING WALL	FINISH	OPTIONS ²²
1C - 1 circuit #MC ¹¹ - Multi circuit EC - Emergency-powered fixture NL - Night light fixture DL - Daylight fixture GTD ^{12,13} - Generator transfer device fixture ¹¹ Specify total number of circuits (#), including any required for electrical section options. Provide drawing or layout specifications. Minimum 4' section per circuit. ¹² Minimum 4' fixture. ¹³ Not available with 347V.	#EC## ¹⁶ - Emergency-powered section #NL## ¹⁶ - Night light section #DL## ¹⁶ - Daylight section #GTD## ^{16,17,18} - Generator transfer device section #EMB ^{18,19} - Emergency battery NA - None ¹⁴ Specify with multi circuit (#MC) electrical option only. ¹⁵ Provide drawing or layout specifications. Consult factory for other configurations. Default section length is 4'. ¹⁶ Specify quantity (#), and section length in inches (##). ¹⁷ Minimum 4' section. ¹⁸ Not available with 347V. ¹⁹ Specify quantity (#). All batteries will be on the same circuit. Each battery powers a 4' section.	TG9 - Tegular 9/16" TG15 - Tegular 15/16" TB9 - T-bar 9/16" TB15 - T-bar 15/16" ST - Screw slot T-bar MTR - Trim MTL - Trimless DMF - Drywall mud flange NA - Not applicable MFM ²¹ - Multiple flange mounting ²⁰ Transition mounting options also available (e.g. Recessed to Surface), consult factory for details. ²¹ See page 4 for details.	MTR - Trim MTL - Trimless DMF - Drywall mud flange NA - Not applicable	W - Matte white AL - Aluminum B - Matte black CF# - Custom finish, specify RAL#	FU120 - Fuse 120V FU277 - Fuse 277V FWC - Flexible whip cable (6' std) CP - Chicago Plenum NA - None ²² Separate codes with a "+" if more than one is specified.

TECHZONE™ & USG Compatible with 4" ceiling

3737 Cote Vertu St-Laurent, Quebec, Canada H4R 2C9
T (514) 225-4304 F (514) 931-4862
www.lumenwerx.com



Lumenwerx reserves the right to modify product specifications without notification.
© Lumenwerx, ULC. All rights reserved.
SHALO-ULTRA-3-RECESSED-PAT-SPEC-REVO March 31, 2025

SHALO ULTRA 3 PATTERN

RECESSED



Dimensions

INTEGRAL

MTR - Trim

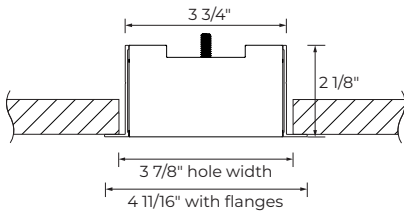

MTL - Trimless

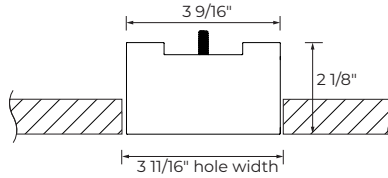

DMF - Drywall mud flange

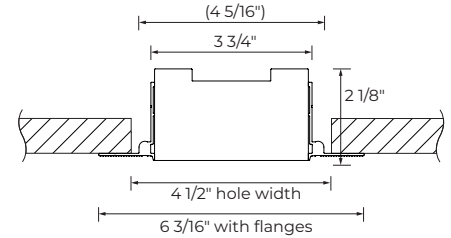

TG9/TB9/TG15/TB15/ST - Grid

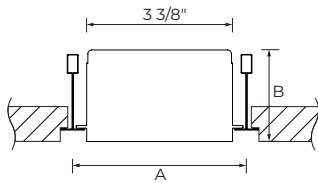

TG9

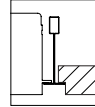

TB9

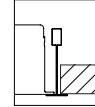

TG15

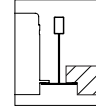

TB15

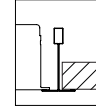

ST

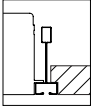

A Between T-bars	4"	4"	4 3/8"	4 3/8"	4"
B Height	2 1/8"	1 13/16"	2 1/8"	1 13/16"	2 1/8"

For grid, driver access from the top.

REMOTE

MTR - Trim

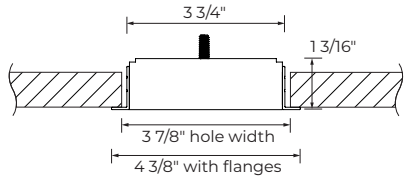

MTL - Trimless

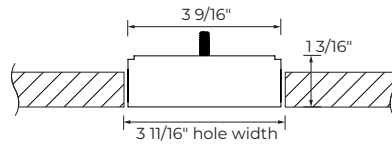

DMF - Drywall mud flange

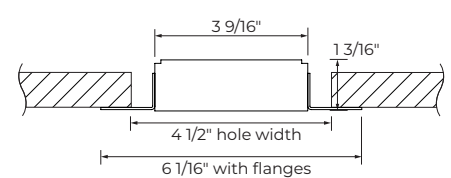

TG9/TB9/TG15/TB15/ST - Grid

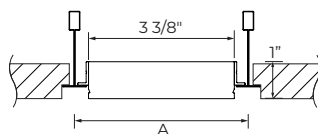

TG9

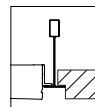

TB9

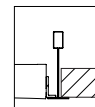

TG15

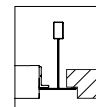

TB15

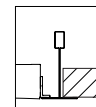

ST

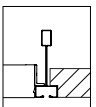

A Between T-bars	4"	4"	4 3/8"	4 3/8"	4"
-------------------------	----	----	--------	--------	----

SHALO ULTRA 3 PATTERN



RECESSED

Multiple Flange Mounting Details

Multiple flange mounting can be specified when a fixture run needs to have a multiple flange recessed mounting detail. A drawing is required to clearly illustrate the application.

CEILING CONDITION EXAMPLES (consult factory for project specific ceiling conditions)

DRYWALL/GRID

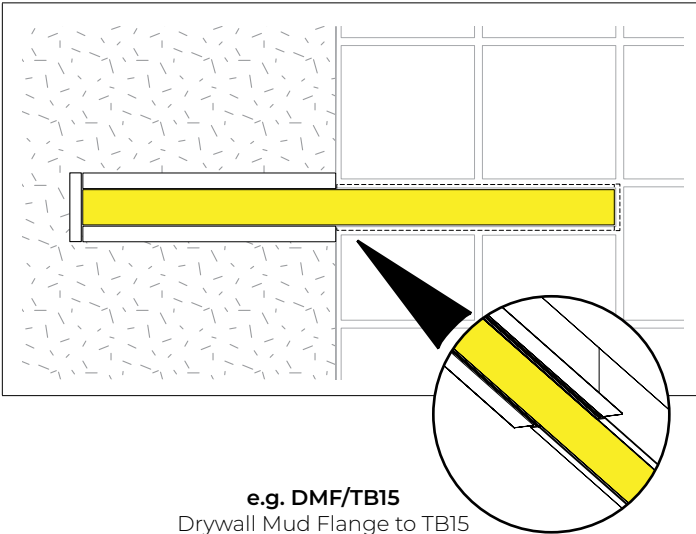

DRYWALL/WOOD

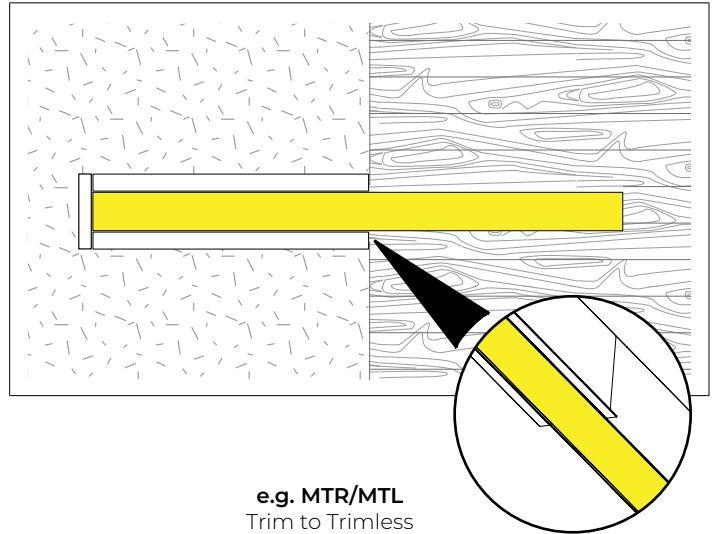

DRYWALL/GRID

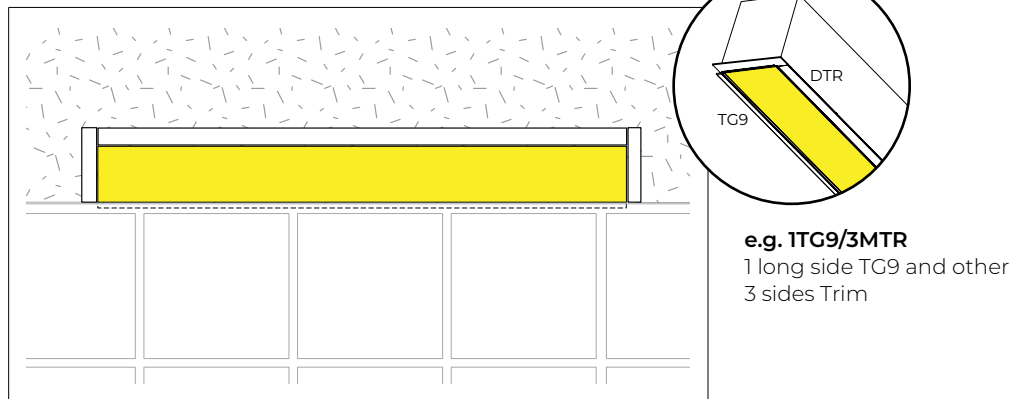

All drawings are for illustrative purposes only.

TRANSITION MOUNTING OPTIONS (consult factory for details)

Mounting condition alters along the run of the fixture.

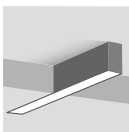

Recessed to Surface

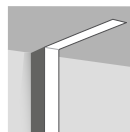

Surface to Recessed in corner

SHALO ULTRA 3 PATTERN



RECESSED

Pattern Layout

CORNER TYPES

LEVELED CORNER

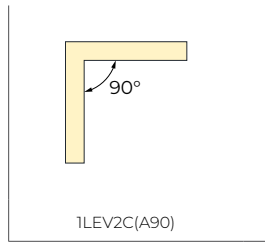

INNER CORNER

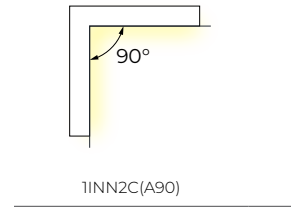

EXAMPLES

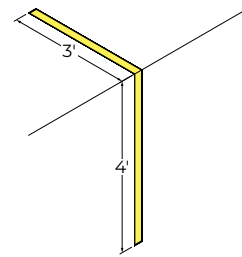
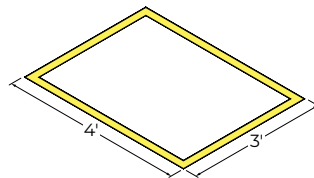
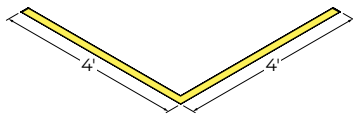

Photometrics

Values calculated based on a 4' fixture at 3500K and 90+ CRI for all optics.

SLO

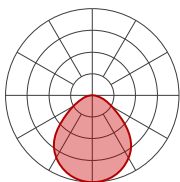

LM/FT	W/FT	LM/W
250	2	125
350	2.9	122
500	4.2	119
750	6.4	117
1000	8.7	114

SMPO

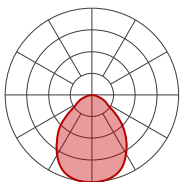

LM/FT	W/FT	LM/W
250	2	122
350	2.9	119
500	4.3	116
750	6.6	114
1000	9	111

MULTIPLIER TABLE

Use this table to get results for different color temperatures and CRI for all photometric tables.

Multiplier - CCT/CRI

CCT	WATTS		LPW	
	80+ CRI	90+ CRI	80+ CRI	90+ CRI
2700K	1.05	1.27	0.95	0.79
3000K	1.02	1.23	0.98	0.81
3500K	1.00	1.19	1.00	0.84
4000K	1.00	1.19	1.00	0.84
5000K	0.96	1.12	1.04	0.89

SHALO ULTRA 3 PATTERN

RECESSED



Technical Specifications

OPTICS

Shallow Lambertian Optic (SLO)

A low-profile optic with diffusing acrylic that provides wide light distribution, with matte white reflectors enhancing LED output spread.

Shallow Micro-Prismatic Optic (SMPO)

A low-profile optic featuring a micro-prismatic lens that balances refraction and reflection, reducing glare while maintaining efficiency and uniform light distribution.

LIGHT SOURCE

Static white

Custom array of mid-flux LEDs are cartridge-mounted with quick-connect wiring to facilitate service and thermal management. Available in 2700K, 3000K, 3500K, 4000K, and 5000K with a minimum 80+ CRI and an option for 90+ CRI with elevated R9 value. Color consistency maintained to within 3 SDCM. LEDs operate at reduced drive current to optimize efficacy and lumen maintenance. All LEDs have been tested in accordance with IESNA LM-80-08 and the results have shown L80 lumen maintenance greater than 60,000 hours. Absolute product photometry is measured and presented in accordance with IESNA LM-79, unless otherwise indicated.

PATTERN LENGTH

All individual sections are joined together onsite using the joiner kits provided. Lumenwerx offers joiner kits that are extremely simple to work with in the field and result in a fixture that appears virtually seamless with no light leak at any connection.

ELECTRICAL

Factory-set, adjustable output current LED driver with universal (120-277 VAC) input. Dimmable from 100% to 1% with 0-10V dimming control. Rated life (90% survivorship) of 50,000 hours at 50°C max. ambient (and 70°C max. case) temperature. At maximum driver load: Efficiency > 84%, PF > 0.9, THD < 20%. Other specifiable options include Lutron Hi-Lume 1% Eco, eldoLED 1% ECOdrive 0-10V, eldoLED 0.1% SOLOdrive 0-10V, ELV, TRIAC, and DALI protocol drivers. All of our standard 0-10V drivers are NEMA 410 compliant.

PoE

Depending on the PoE manufacturer selected, Lumenwerx will install the node in factory as either integral to the luminaire or as a remote module. These must be addressed and evaluated on a case-by-case basis.

ELECTRICAL SECTION OPTIONS

Electrical section options are available for fixtures specified as multi circuit (#MC). With MC, specify the total number of circuits (#), including any circuits required for optional electrical sections. A drawing is required to specify the layout. Please consult factory for custom configurations.

Electrical sections

Options include emergency-powered (#EC##), night light (#NL##), daylight (#DL##), and generator transfer device (#GTD##) sections. Specify the quantity (#), as well as the section length in inches (##).

Example 1: A 32' Direct fixture with two 8' emergency-powered sections on a second circuit.

Code: 2MC-2EC96

Example 2: A 24' Direct fixture with one 4' generator transfer device section.

Code: 1MC-1GTD48

Battery

Factory installed long life, high temperature, maintenance-free Lithium-Ion battery pack with self-test functionality, test switch and charge indicator. Minimum of 90 minutes operation, up to 1000 lumens per 4' (25°C) emergency lighting output and recharge time of 24 hours.

MOUNTING

Recessed fixtures can be mounted into exposed or concealed T-bar or tegular ceiling, as well as in ceilings with trim, trimless, or mud flange options.

FINISH

Interior: 95%, reflective matte powder coated white paint.

Exterior: Matte white, matte black or aluminum powder coating. Custom finishes are also available.

CONSTRUCTION

Housing: Extruded aluminum, up to 90% recycled content

Interior brackets: Die-formed cold rolled sheet steel

Joining system: Die-cast zinc

Reflectors: Plastic

Lens: Acrylic

Recessed flanges: Extruded aluminum, up to 90% recycled content

End plate: Die-formed cold rolled sheet steel

WEIGHT

Integral: 3 lb/ft - 1.35 kg/ft

Remote: 2 lb/ft - 0.9 kg/ft

SHALO ULTRA 3 PATTERN

RECESSED



CERTIFICATIONS

ETL: Rated for indoor dry/damp locations. Conforms to UL Standard 1598 and certified to CAN/CSA Standard C22.2 No. 250.0.

Chicago Plenum: City of Chicago Approved (CCEA) when specified with CP option.

IC rated: Suitable for direct contact with insulation

WARRANTY

Lumenwerx provides a five-year limited warranty on electrical and mechanical performance of the luminaires, including the LED boards, drivers, and auxiliary electronics. Lumenwerx will repair or replace defective luminaires or components at our discretion, provided they have been installed and operated in accordance with our specifications. Other limitations apply, please refer to the full warranty on our website.