

SHALO ULTRA 3

RECESSED

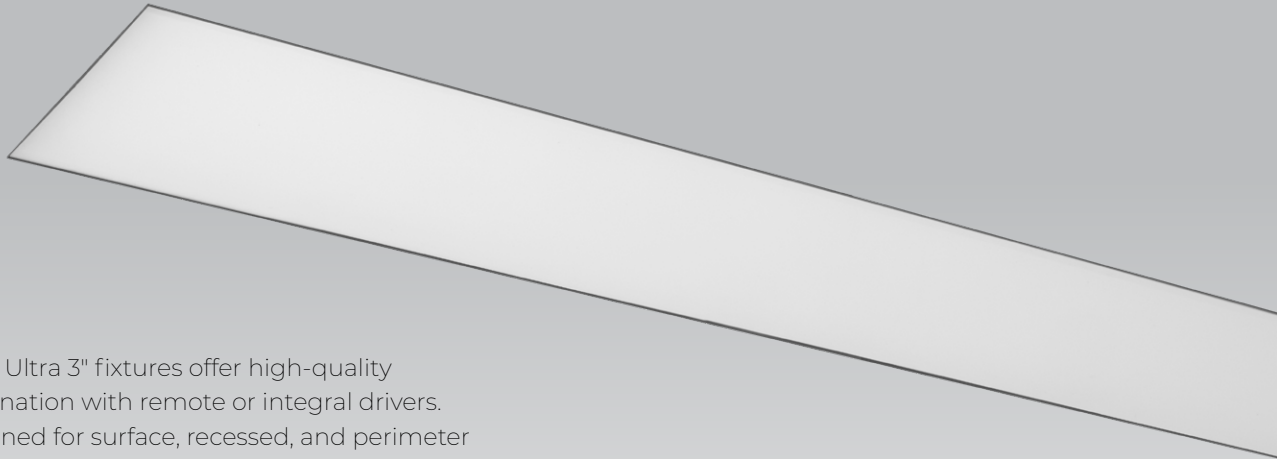

Shalo Ultra 3" fixtures offer high-quality illumination with remote or integral drivers. Designed for surface, recessed, and perimeter mounting, they work with various ceiling types and feature optic options for low-glare, visually comfortable lighting.



SENSORS
For latest information on sensors, click [here](#).



Grid

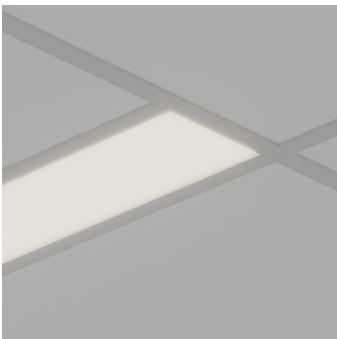

Drywall

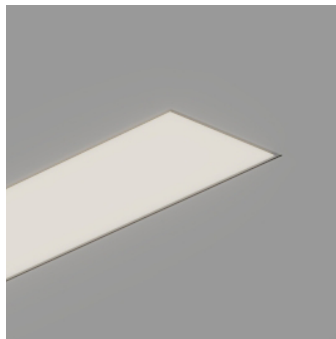

Wood



Multiple flange (Drywall/Grid)



SHALO ULTRA 3

RECESSED



Project: _____

Type: _____

Order Guide

IC RATED

LUMINAIRE ID	DISTRIB.	DRIVER LOCATION	OPTIC	LIGHT SOURCE	CRI	LUMEN PACKAGE	COLOR TEMP.
SHLU3R	D			SW			
SHLU3R - Shalo Ultra 3" Recessed	D - Direct	INTEGRAL ¹ - Integral driver REMOTE ² - Remote driver ¹ Fixture height is 2 1/8" ² Fixture height is 1 3/16"	SLO - Shallow Lambertian Optic SMPO - Shallow Micro-Prismatic Optic	SW - Static white	80CRI - 80+ CRI 90CRI - 90+ CRI	250LMF - Hypo output 250 lm/ft 350LMF - Low output 350 lm/ft 500LMF - Medium output 500 lm/ft 750LMF - High output 750 lm/ft 1000LMF - Hyper output 1000 lm/ft	27K - 2700K 30K - 3000K 35K - 3500K 40K - 4000K 50K - 5000K

LUMINAIRE LENGTH	VOLTAGE	DRIVER	ELECTRICAL
#FT#IN - Specify nominal length (#) in 1' and/or 1" increments Standard nominal lengths: Single units: 2' to 8' Continuous runs: lengths over 8'	120V - 120V 277V - 277V UNV - 120V-277V 347V ³ - 347V ³ Available with D1 or RD1 driver only.	INTEGRAL D1 - 1% 0-10V ELV ⁴ - ELV 120V TRI ⁴ - TRIAC 120V DA ⁵ - DALI LDE1 ⁵ - Lutron Hi-Lume 1% Eco ELD1 - eldoLED 1% ECOdrive 0-10V ELDO - eldoLED 0.1% SOLOdrive 0-10V ⁴ Available with 120V only. ⁵ On-site commissioning is required. ⁶ A remote driver box is provided.	REMOTE ⁶ RD1 - 1% 0-10V RELV ⁴ - ELV 120V RTRI ⁴ - TRIAC 120V RDA ⁵ - DALI RLDE1 ⁵ - Lutron Hi-Lume 1% Eco RELD1 - eldoLED 1% ECOdrive 0-10V RELDO - eldoLED 0.1% SOLOdrive 0-10V ⁷ Specify total number of circuits (#), including any required for electrical section options. Provide drawing or layout specifications. Minimum 4' section per circuit. ⁸ Minimum 4' fixture. ⁹ Not available with 347V.

ELECTRICAL SECTIONS (optional) ^{10,11}	MOUNTING ¹⁶	FINISH	OPTIONS ¹⁸
#EC## ¹² - Emergency-powered section #NL## ¹² - Night light section #DL## ¹² - Daylight section #GTD## ^{12,13,14} - Generator transfer device section #EMB ^{14,15} - Emergency battery NA - None ¹⁰ Specify with multi circuit (#MC) electrical option only. ¹¹ Provide drawing or layout specifications. Consult factory for other configurations. Default section length is 4'. ¹² Specify quantity (#), and section length in inches (##). ¹³ Minimum 4' section. ¹⁴ Not available with 347V. ¹⁵ Specify quantity (#). All batteries will be on the same circuit. Each battery powers a 4' section.	TG9 - Tegular 9/16" TG15 - Tegular 15/16" TB9 - T-bar 9/16" TB15 - T-bar 15/16" ST - Screw slot T-bar MTR - Trim MTL - Trimless DMF - Drywall mud flange MFM ¹⁷ - Multiple flange mounting ¹⁶ Transition mounting options also available (e.g. Recessed to Surface), consult factory for details. ¹⁷ See page 4 for details.	W - Matte white AL - Aluminum B - Matte black CF# - Custom finish, specify RAL#	FUI20 - Fuse 120V FU277 - Fuse 277V FWC - Flexible whip cable (6' std) CP - Chicago Plenum NA - None ¹⁸ Separate codes with a "*" if more than one is specified.

TECHZONE™ & USG Compatible with 4" ceiling

3737 Cote Vertu St-Laurent, Quebec, Canada H4R 2C9
T (514) 225-4304 F (514) 931-4862
www.lumenwerx.com



Lumenwerx reserves the right to modify product specifications without notification.
© Lumenwerx, ULC. All rights reserved.
SHALO-ULTRA-3-RECESSED-SPEC-REVO March 31, 2025

SHALO ULTRA 3

RECESSED



Dimensions

INTEGRAL

MTR - Trim

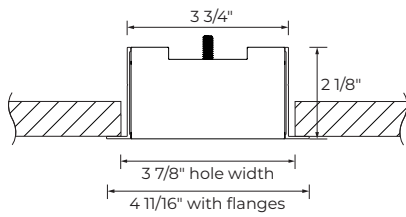

MTL - Trimless

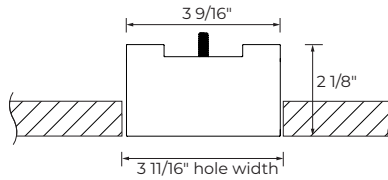

DMF - Drywall mud flange

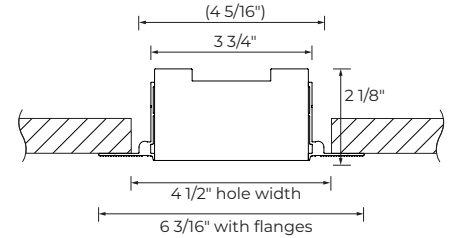

TG9/TB9/TG15/TB15/ST - Grid

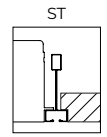
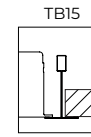
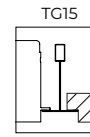
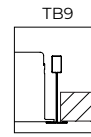
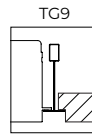
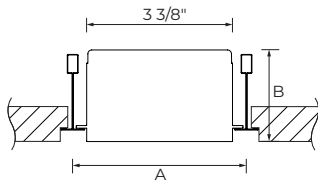

A Between T-bars	4"	4"	4 3/8"	4 3/8"	4"
B Height	2 1/8"	1 13/16"	2 1/8"	1 13/16"	2 1/8"

For grid, driver access from the top.

REMOTE

MTR - Trim

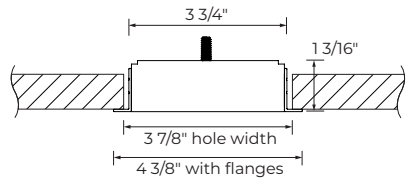

MTL - Trimless

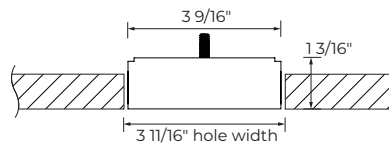

DMF - Drywall mud flange

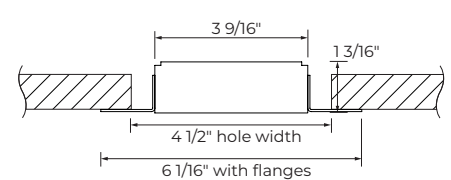

TG9/TB9/TG15/TB15/ST - Grid

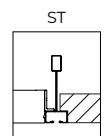
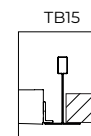
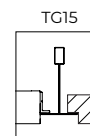
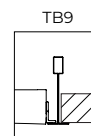
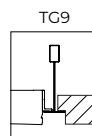
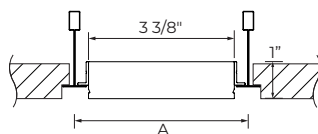

A Between T-bars	4"	4"	4 3/8"	4 3/8"	4"
-------------------------	----	----	--------	--------	----

SHALO ULTRA 3

RECESSED



Multiple Flange Mounting Details

Multiple flange mounting can be specified when a fixture run needs to have a multiple flange recessed mounting detail. A drawing is required to clearly illustrate the application.

CEILING CONDITION EXAMPLES (consult factory for project specific ceiling conditions)

DRYWALL/GRID

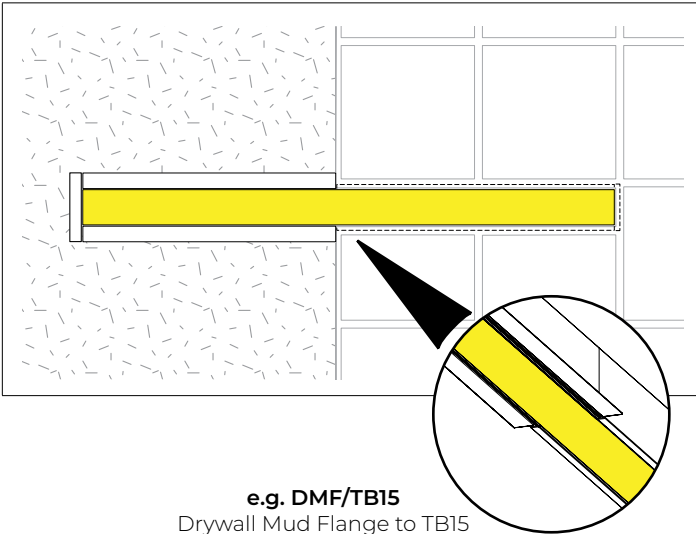

e.g. DMF/TB15
Drywall Mud Flange to TB15

DRYWALL/WOOD

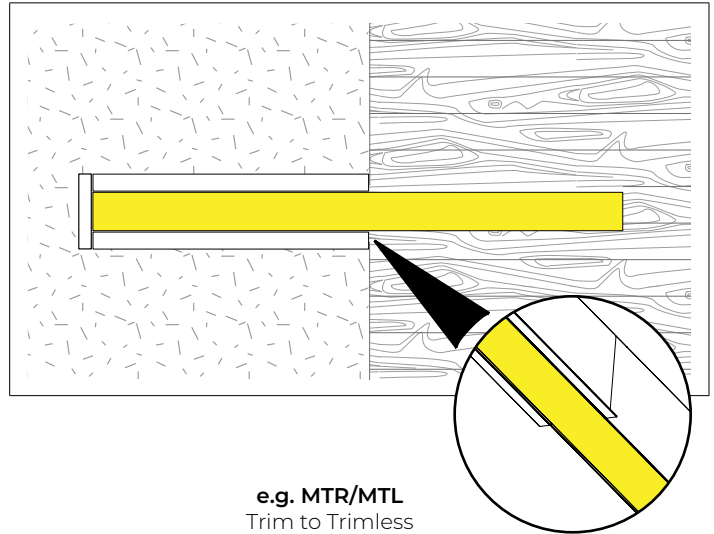

e.g. MTR/MTL
Trim to Trimless

DRYWALL/GRID

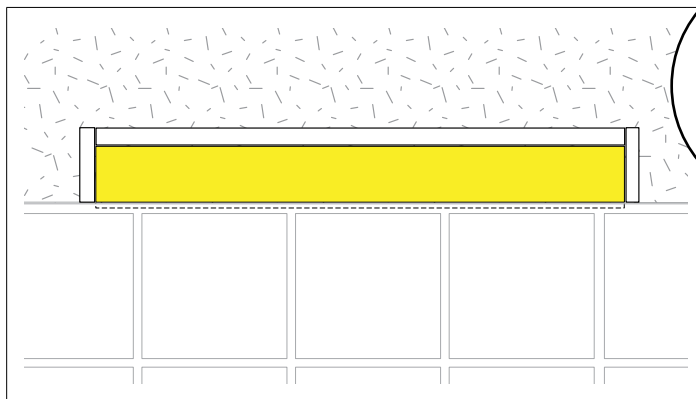

e.g. 1TC9/3MTR
1 long side TC9 and other
3 sides MTR

All drawings are for illustrative purposes only.

TRANSITION MOUNTING OPTIONS (consult factory for details)

Mounting condition alters along the run of the fixture.

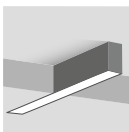

Recessed to Surface

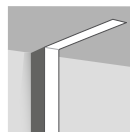

Surface to Recessed in corner

SHALO ULTRA 3

RECESSED



Photometrics

Values calculated based on a 4' fixture at 3500K and 90+ CRI for all optics.

SLO

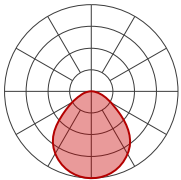

LM/FT	W/FT	LM/W
250	2	125
350	2.9	122
500	4.2	119
750	6.4	117
1000	8.7	114

SMPO

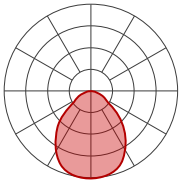

LM/FT	W/FT	LM/W
250	2	122
350	2.9	119
500	4.3	116
750	6.6	114
1000	9	111

MULTIPLIER TABLE

Use this table to get results for different color temperatures and CRI for all photometric tables.

Multiplier - CCT/CRI

CCT	WATTS		LPW	
	80+ CRI	90+ CRI	80+ CRI	90+ CRI
2700K	1.05	1.27	0.95	0.79
3000K	1.02	1.23	0.98	0.81
3500K	1.00	1.19	1.00	0.84
4000K	1.00	1.19	1.00	0.84
5000K	0.96	1.12	1.04	0.89

SHALO ULTRA 3

RECESSED



Technical Specifications

OPTICS

Shallow Lambertian Optic (SLO)

A low-profile optic with diffusing acrylic that provides wide light distribution, with matte white reflectors enhancing LED output spread.

Shallow Micro-Prismatic Optic (SMPO)

A low-profile optic featuring a micro-prismatic lens that balances refraction and reflection, reducing glare while maintaining efficiency and uniform light distribution.

LIGHT SOURCE

Static white

Custom array of mid-flux LEDs are cartridge-mounted with quick-connect wiring to facilitate service and thermal management. Available in 2700K, 3000K, 3500K, 4000K, and 5000K with a minimum 80+ CRI and an option for 90+ CRI with elevated R9 value. Color consistency maintained to within 3 SDCM. LEDs operate at reduced drive current to optimize efficacy and lumen maintenance. All LEDs have been tested in accordance with IESNA LM-80-08 and the results have shown L80 lumen maintenance greater than 60,000 hours. Absolute product photometry is measured and presented in accordance with IESNA LM-79, unless otherwise indicated.

LUMINAIRE LENGTH

Shalo Ultra is available in standard lengths of 2' to 8'. Continuous runs are available for run lengths over 8'. Exact run length must be noted in the product code. The minimum length is 2', and can be ordered in 1' and/or 1" increments. All individual sections are joined together onsite using the joiner kits provided. Lumenwerx offers joiner kits that are extremely simple to work with in the field and result in a fixture that appears virtually seamless with no light leak at any connection.

ELECTRICAL

Factory-set, adjustable output current LED driver with universal (120-277 VAC) input. Dimmable from 100% to 1% with 0-10V dimming control. Rated life (90% survivorship) of 50,000 hours at 50°C max. ambient (and 70°C max. case) temperature. At maximum driver load: Efficiency > 84%, PF > 0.9, THD < 20%. Other specifiable options include Lutron Hi-Lume 1% Eco, eldoLED 1% ECOdrive 0-10V, eldoLED 0.1% SOLOdrive 0-10V, ELV, TRIAC, and DALI protocol drivers. All of our standard 0-10V drivers are NEMA 410 compliant.

PoE

Depending on the PoE manufacturer selected, Lumenwerx will install the node in factory as either integral to the luminaire or as a remote module. These must be addressed and evaluated on a case-by-case basis.

ELECTRICAL SECTION OPTIONS

Electrical section options are available for fixtures specified as multi circuit (#MC). With MC, specify the total number of circuits (#), including any circuits required for optional electrical sections. A drawing is required to specify the layout. Please consult factory for custom configurations.

Electrical sections

Options include emergency-powered (#EC##), night light (#NL##), daylight (#DL##), and generator transfer device (#GTD##) sections. Specify the quantity (#), as well as the section length in inches (##).

Example 1: A 32' Direct fixture with two 8' emergency-powered sections on a second circuit.

Code: 2MC-2EC96

Example 2: A 24' Direct fixture with one 4' generator transfer device section.

Code: 1MC-1GTD48

Battery

Factory installed long life, high temperature, maintenance-free Lithium-Ion battery pack with self-test functionality, test switch and charge indicator. Minimum of 90 minutes operation, up to 1000 lumens per 4' (25°C) emergency lighting output and recharge time of 24 hours.

MOUNTING

Recessed fixtures can be mounted into exposed or concealed T-bar or tegular ceiling, as well as in ceilings with trim, trimless, or mud flange options.

FINISH

Interior: 95%, reflective matte powder coated white paint.

Exterior: Matte white, matte black or aluminum powder coating. Custom finishes are also available.

CONSTRUCTION

Housing: Extruded aluminum, up to 90% recycled content

Interior brackets: Die-formed cold rolled sheet steel

Joining system: Die-cast zinc

Reflectors: Plastic

Lens: Acrylic

Recessed flanges: Extruded aluminum, up to 90% recycled content

End plate: Die-formed cold rolled sheet steel

SHALO ULTRA 3

RECESSED



WEIGHT

Integral: 3 lb/ft - 1.35 kg/ft

Remote: 2 lb/ft - 0.9 kg/ft

CERTIFICATIONS

ETL: Rated for indoor dry/damp locations. Conforms to UL Standard 1598 and certified to CAN/CSA Standard C22.2 No. 250.0.

Chicago Plenum: City of Chicago Approved (CCEA) when specified with CP option.

IC rated: Suitable for direct contact with insulation

WARRANTY

Lumenwerx provides a five-year limited warranty on electrical and mechanical performance of the luminaires, including the LED boards, drivers, and auxiliary electronics. Lumenwerx will repair or replace defective luminaires or components at our discretion, provided they have been installed and operated in accordance with our specifications. Other limitations apply, please refer to the full warranty on our website.