

SQUERO COMBINATION

RECESSED PATTERN

STATIC WHITE



Declare.



DESCRIPTION

Squero Combination Pattern brings style and flexibility to linear lighting systems. Less than 2" wide, Squero offers a variety of optics, each providing a different visual texture, as well as photometric performance. Squero Combination allows various optics to be combined in a single luminaire. Optional modules are also available for accent lighting. It can be installed as individual luminaires, in continuous runs, or as patterns. See separate spec sheets for Squero and Squero Combination.

SENSORS
For latest information on sensors, click [here](#).



Up to 130 lm/W performance

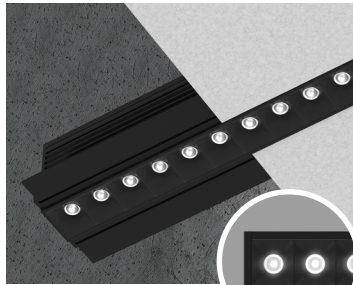

MRO
Miniature Reflector Optics

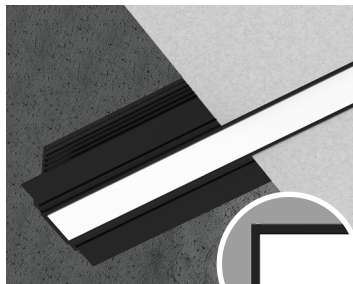
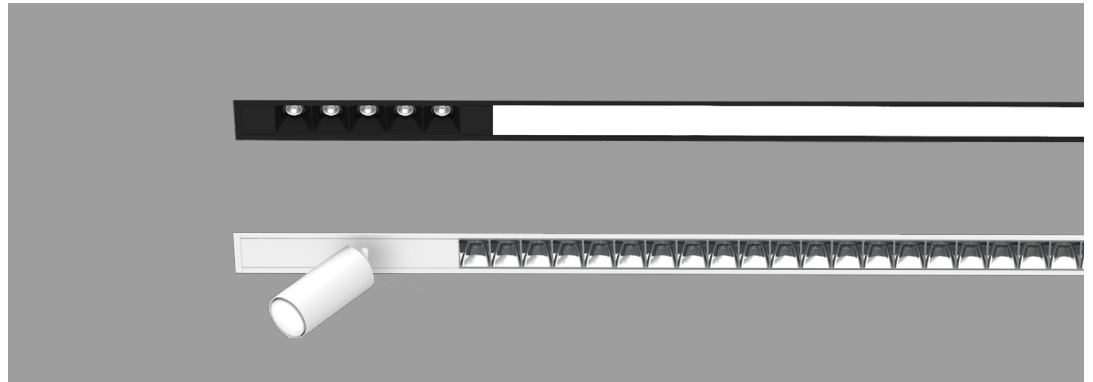

HLO
High-Efficiency Lambertian Optic

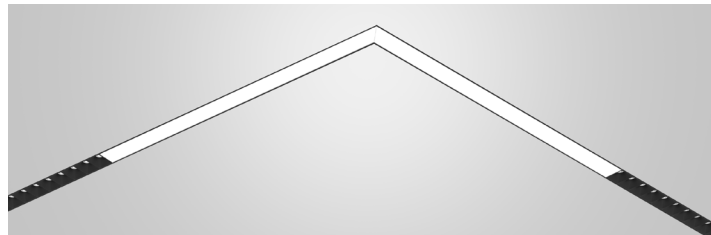

LIT CORNER¹

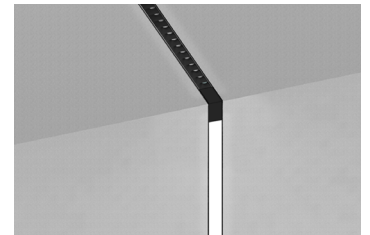

UNLIT CORNER¹



MBPL
Matte Black Parabolic Louver

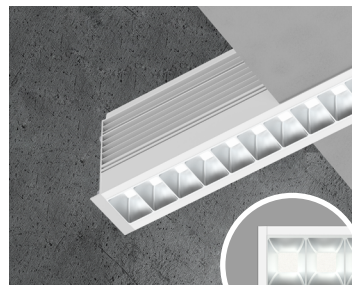

MPL
Matte Parabolic Louver



SPL
Specular Parabolic Louver

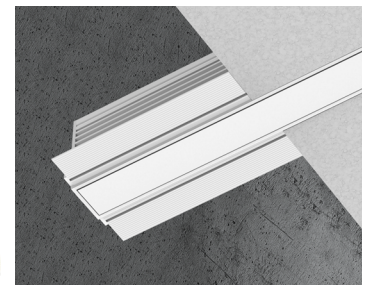

BLA
Blank

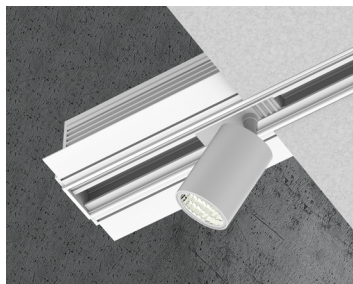

ITRLMX, ITR
Integrated Track

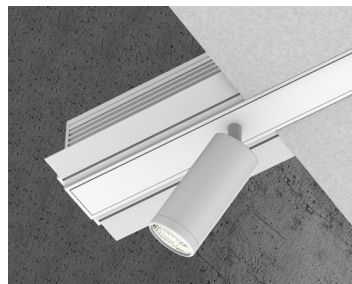

AAM
Adjustable Accent Module

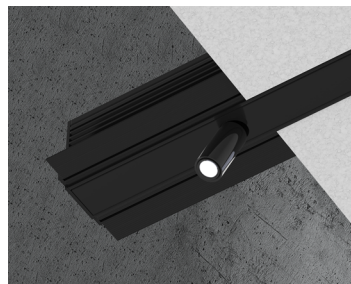

MS
Micro Spot Module

¹Lit corners are only available with HLO, min corner dimensions 2"x2". Unlit corner min dimensions 6"x6".

SQUERO COMBINATION

RECESSED PATTERN

STATIC WHITE



Project: _____

Type: _____

Order Guide

Example: SQUCOMRPAT-D-6FT-MRO18-2FT-HLO-2FT6IN-BLA-1FT6IN-WH-SW-80CRI-350LMF-27K-LEV-BLA-90COR(1)-120V-D1-1C-NA-TG9-W-NA-NA-1AAM21(80CRI-350LM-27K-W-NA)

A drawing of your combination pattern is required - anything from a line drawing to an architectural drawing.

LUMINAIRE ID	DISTRIBUTION	TOTAL PATTERN LENGTH ¹	OPTICS ^{3,4} Specify the total length for each required optic, including the corner lengths.	MRO COLOR	
SQUCOMRPAT	D				
SQUCOMRPAT - Squero Combination Recessed Pattern	D - Direct	#FT#IN ² - Specify the total nominal length (#) in 1' and/or 1" increments Continuous runs: lengths over 12' ¹ Total luminaire length should equal the sum of all the optic lengths. ² Minimum fixture length is 4'.	MRO18 ⁵ - 18 degree Miniature Reflector Optic MRO35 ⁵ - 35 degree Miniature Reflector Optic MRO55 ⁵ - 55 degree Miniature Reflector Optic MBPL ⁶ - Matte Black Parabolic Louver MPL ⁶ - Matte Parabolic Louver SPL ⁶ - Specular Parabolic Louver HLO - High-Efficiency Lambertian Optic BLA ⁷ - Blank ITRLMX ⁸ - Integrated track by Lumenwerx ITR ^{8,9} - Integrated track by others	FT IN IN FT FT FT FT IN IN IN FT IN	WH ¹⁰ - White BK ¹⁰ - Black NA - Not applicable ¹⁰ Only available with MRO optics.
³ Specify MROs in 6" increments, Parabolic Louvers in 1" increments, HLO and Blank in 1" increments. ⁶ Not available with BLOSTU. ⁴ The minimum total length per louver/optic must be 2' in each section of the fixture. ⁷ A minimum 6" blank section must be specified for each AAM or Micro Spot option. ⁵ Not available with BIOS. ⁸ Specify track length in 1' and/or 1" increments. ⁹ Track by others and installed by Lumenwerx. Consult factory.					
LIGHT SOURCE	CRI	LUMEN PACKAGE	COLOR TEMP.	CORNER TYPE ¹⁵	
SW - Static white	80CRI - 80+ CRI 90CRI ¹² - 90+ CRI	350LMF - Eco low output 350 lm/ft 500LMF - Low output 500 lm/ft 750LMF - Medium output 750 lm/ft 1000LMF ^{13,14} - High output 1000 lm/ft NA - Not applicable	27K ¹⁵ - 2700K 30K - 3000K 35K - 3500K 40K - 4000K 50K ¹⁵ - 5000K	#LEV2C(A##XX) ¹⁷ - 2-way leveled corner #LEV3C(A##XX) ^{18,19} - 3-way leveled corner #LEV4C(A##XX) ^{18,19} - 4-way leveled corner #INN2C(A90XX) ²⁰ - 2-way inner corner #OUT2C(A90XX) ²⁰ - 2-way outer corner	
BIOSST ¹¹ - BIOS Biological Static BIOSDY ¹¹ - BIOS Biological Dynamic BLOSTU ¹¹ - BIOS Biological Tunable	¹² Not available with BIOS.	¹³ Not available with MBPL optic. ¹⁴ Not available with BIOS.	¹⁵ Not available with BIOS.	ANGLE (A##): (A60) - 60° (A90) - 90° (A120) - 120° (A##) - Custom OPTIC (XX): HLO - High-Efficiency Lambertian Optic corner min 2'x2' BLA - Blank corner min 6"x6"	
¹¹ See page 8 for details. ¹⁶ Specify quantity (#), angle (A##), and optic (XX) for each required corner type. Separate corner types with a "+" if more than one is required, e.g. 1LEV2C(A90HLO)+2LEV2C(A60BLA). ¹⁷ Minimum angle is 30°. ¹⁸ Minimum angle is 60°. ¹⁹ Separate angles with a "+" if more than one type is required, e.g. 1LEV4C(A60+A90). ²⁰ Available with 90° only. Consult factory for other angles.					
VOLTAGE	DRIVER ²²	ELECTRICAL	ELECTRICAL SECTIONS (optional) ^{28,29}	MOUNTING ³⁴	
120V - 120V 277V - 277V UNV - 120V-277V 347V ²¹ - 347V	D1 - 1% 0-10V ELV ²³ - ELV 120V TRI ²³ - TRIAC 120V DA ²⁴ - DALI LDE1 ²⁴ - Lutron Hi-Lume 1% Eco ELD1 - eldoLED 1% ECOdrive 0-10V ELDO - eldoLED 0.1% SOLOdrive 0-10V	1C - 1 circuit #MC ²⁵ - Multi circuit EC - Emergency-powered fixture NL - Night light fixture DL - Daylight fixture CTD ^{26,27} - Generator transfer device fixture	#EC## ³⁰ - Emergency-powered section #NL## ³⁰ - Night light section #DL## ³⁰ - Daylight section #GTD## ^{30,31,32} - Generator transfer device section #EMB ^{32,33} - Emergency battery NA - None	TG9 - Tegular 9/16" TG15 - Tegular 15/16" TB9 - T-bar 9/16" TB15 - T-bar 15/16" ST - Screw slot T-bar DTR - Trim DTL - Trimless DMF - Drywall mud flange MFM ³⁵ - Multiple flange mounting	
²¹ Available with D1 driver only.	²² PoE (Power-over-Ethernet) compatible. Consult factory for details. ²³ Available with 120V only. ²⁴ On-site commissioning is required.	²⁵ Specify total number of circuits (#), including any required for electrical section or module options. Provide drawing or layout specifications. Minimum 4' section per circuit. ²⁶ Minimum 4' fixture. ²⁷ Not available with 347V.	²⁸ Specify with multi circuit (#MC) electrical option only. ²⁹ Provide drawing or layout specifications. Consult factory for other configurations. Default section length is 4'. ³⁰ Specify quantity (#), and section length in inches (##). ³¹ Minimum 4' section. ³² Not available with 347V. ³³ Specify quantity (#). All batteries will be on the same circuit. Each battery powers a 4' section.	³⁴ Transition mounting options also available (e.g. Recessed to Pendant/Surface), consult factory for details. ³⁵ See page 4 for details.	
FINISH ³⁶	CONTROL ³⁷	OPTIONS ⁴³		MODULE (optional) ^{45,46}	
W - Matte white AL - Aluminum B - Matte black CF# - Custom finish, specify RAL#	STANDALONE CONTROLS ^{38,39} Specify the quantity (#) of sensors per fixture. #OMS ⁴⁰ - Onboard Occupancy #OMS## ⁴¹ - Onboard Occupancy with bi-level dimming #ODS - Onboard Daylight #OCS - Onboard Occupancy & Daylight	CONNECTED CONTROLS ⁴² LU - Lutron AWN - Lutron Athena AWNR - Lutron Athena Wireless Node RF Only AWNS - Lutron Athena Wireless Node Sensor ENC - Encelium	WL - Cooper Wavelinx ANA - Acuity nLight Air CA - Casambi LG - Legrand	FUI20 - Fuse 120V FU277 - Fuse 277V NEF ⁴⁴ - No end flanges FWC - Flexible whip cable (6' std) NA - None	
³⁶ Blank finish will match fixture finish.	³⁷ Standalone and connected control options cannot be combined. ³⁸ Available with D1 driver and 1 circuit options only. ³⁹ Minimum 4' per zone. Provide control zone length.	⁴⁰ Fixture turns off when no occupancy. ⁴¹ Fixture dims to specified light level % (##). ⁴² Consult factory for connected controls.	⁴³ Separate codes with a "+" if more than one is specified. ⁴⁴ For wall-to-wall installations.	⁴⁵ See page 3 for ordering details. ⁴⁶ Not available with ELV/TRI driver options.	



SQUERO COMBINATION

RECESSED PATTERN

STATIC WHITE



Module Code

For a module, specify the options in the parentheses.
The light source is static white.
CRI of module matches specification of main fixture.

Examples: 1AAM21(5W-35K-W-NA)
1MS25(5W-27K-W)

MODULE (optional)				
MODULE ^{1,2}	WATTAGE	COLOR TEMPERATURE	FINISH	OPTION
#AAM21() - AAM 21° #AAM30() - AAM 30° #AAM36() - AAM 36° ¹ Specify quantity (#). ² 6" blank per module. Blank finish will match fixture finish.	5W - 5 W, up to 364 lm output 8W - 8 W, up to 624 lm output	27K - 2700K 30K - 3000K 35K - 3500K 40K - 4000K 50K - 5000K	W - Matte white B - Matte black	HCL - Honeycomb louver NA - None
MODULE ^{1,2}	WATTAGE	COLOR TEMPERATURE	FINISH	
#MS25() - Micro Spot 25° #MS35() - Micro Spot 35° #MS50() - Micro Spot 50° ¹ Specify quantity (#). ² 6" blank per module. Blank finish will match fixture finish.	5W - 5 W, up to 430 lm output	27K - 2700K 30K - 3000K 35K - 3500K 40K - 4000K 50K - 5000K	W - Matte white B - Matte black	

Dimensions

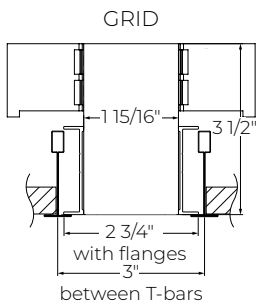
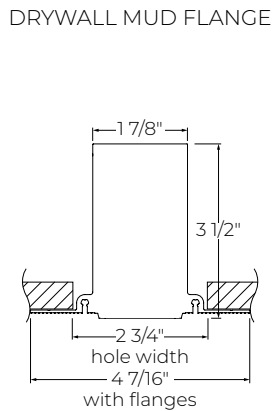
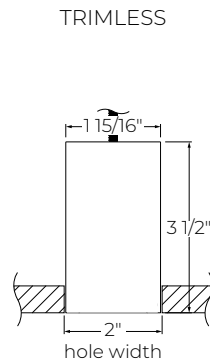
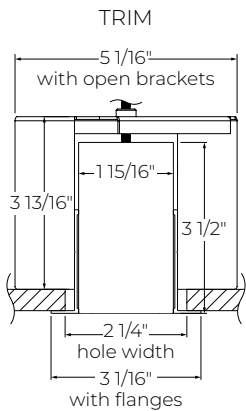

SQUERO COMBINATION

RECESSED PATTERN

STATIC WHITE



Multiple Flange Mounting Details

Multiple flange mounting can be specified when a fixture run needs to have a multiple flange recessed mounting detail. A drawing is required to clearly illustrate the application.

CEILING CONDITION EXAMPLES (consult factory for project specific ceiling conditions)

DRYWALL/GRID

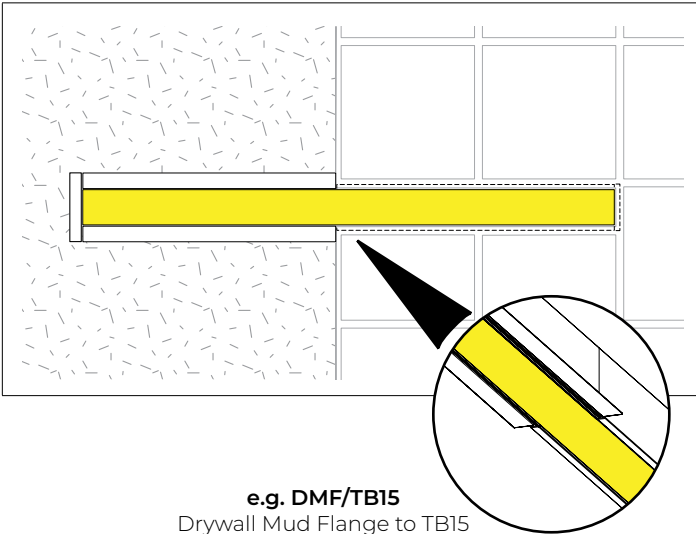

DRYWALL/WOOD

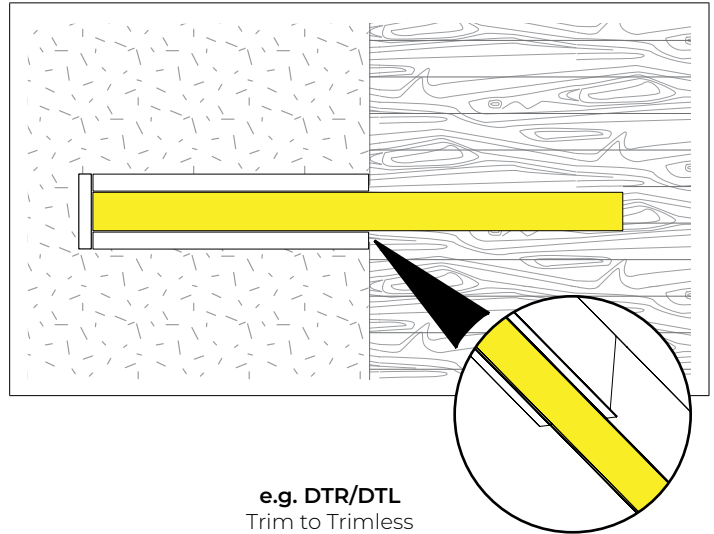

DRYWALL/GRID

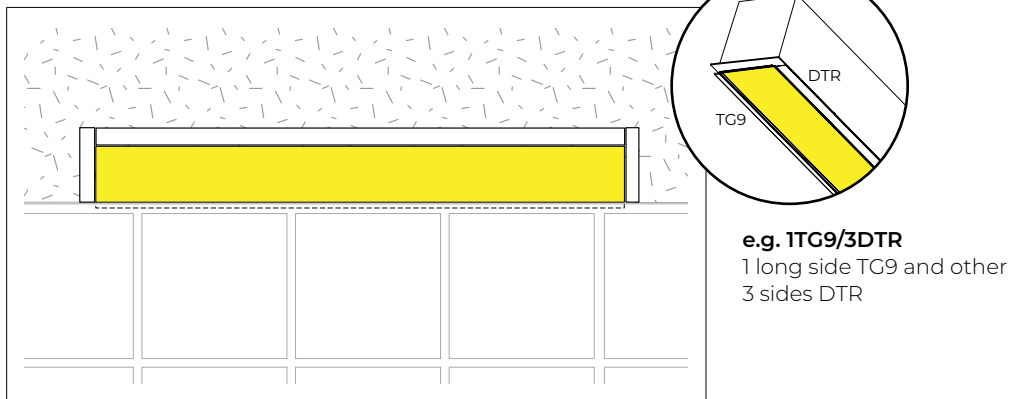

All drawings are for illustrative purposes only.

TRANSITION MOUNTING OPTIONS (consult factory for details)

Mounting condition alters along the run of the fixture.

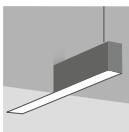

Recessed to Pendant

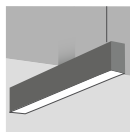

Surface to Pendant

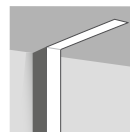

Surface to Recessed in corner

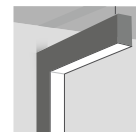

Surface to Pendant in corner

SQUERO COMBINATION

RECESSED PATTERN

STATIC WHITE



Pattern Layout

CORNER TYPES

LEVELED CORNERS

INNER CORNER

OUTER CORNER

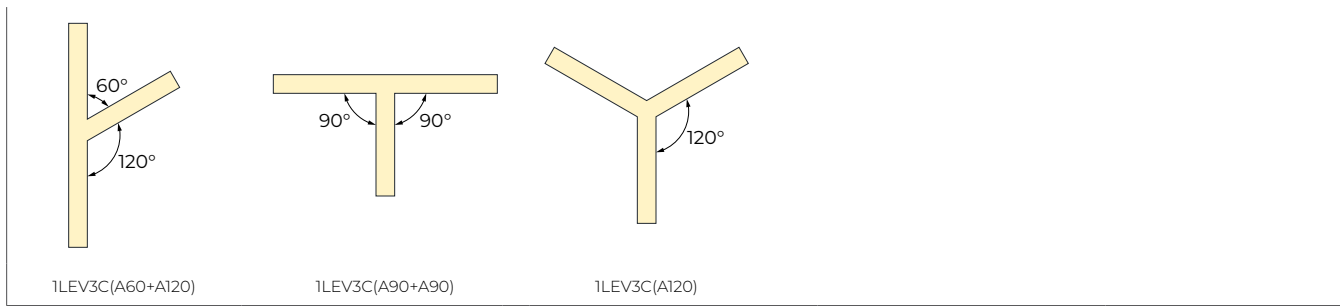

EXAMPLES

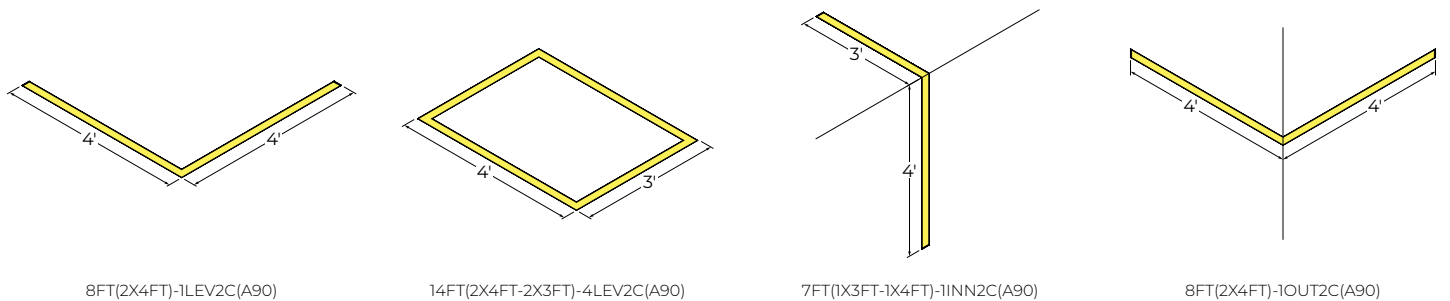

SQUERO COMBINATION

RECESSED PATTERN

STATIC WHITE



Photometrics

Values calculated based on a 4' fixture at 3500K and 80+ CRI for all optics.

MRO18

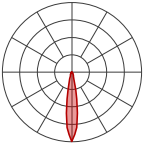

LM/FT	W/FT	LM/W
350	2.7	130
500	4.0	125
750	6.4	118
1000	9.1	110

MRO35

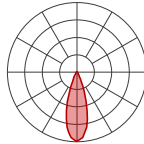

LM/FT	W/FT	LM/W
350	2.9	121
500	4.3	116
750	6.9	108
1000	9.9	101

MRO55

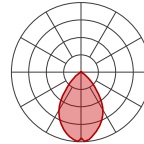

LM/FT	W/FT	LM/W
350	3.2	109
500	4.8	104
750	7.7	97
1000	11.0	91

HLO

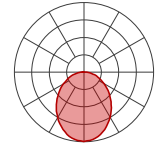

LM/FT	W/FT	LM/W
350	3.1	112
500	4.6	108
750	7.3	103
1000	10.2	98

MBPL

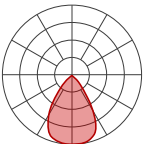

LM/FT	W/FT	LM/W
350	5.2	67
500	7.5	66
750	11.7	64

MPL

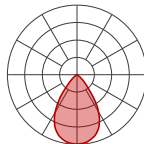

LM/FT	W/FT	LM/W
350	3.5	99
500	5.1	98
750	7.7	98
1000	10.6	95

SPL

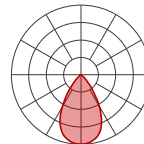

LM/FT	W/FT	LM/W
350	3.1	113
500	4.4	113
750	6.7	112
1000	9.1	109

MULTIPLIER TABLES - CCT/CRI

Use these tables to get results for different color temperatures and CRI for all photometric tables.

MRO18 / MRO35 / MRO55

CCT	WATTS		LPW	
	80+ CRI	90+ CRI	80+ CRI	90+ CRI
2700K	1.04	1.19	0.96	0.84
3000K	1.00	1.15	1.00	0.87
3500K	1.00	1.12	1.00	0.89
4000K	0.99	1.10	1.01	0.91
5000K	0.94	1.06	1.06	0.94

MBPL / MPL / SPL

CCT	WATTS		LPW	
	80+ CRI	90+ CRI	80+ CRI	90+ CRI
2700K	1.04	1.19	0.96	0.84
3000K	1.00	1.15	1.00	0.87
3500K	1.00	1.12	1.00	0.89
4000K	0.99	1.10	1.01	0.91
5000K	0.94	1.06	1.06	0.94

HLO

CCT	WATTS		LPW	
	80+ CRI	90+ CRI	80+ CRI	90+ CRI
2700K	1.05	1.27	0.95	0.79
3000K	1.02	1.23	0.98	0.81
3500K	1.00	1.19	1.00	0.84
4000K	1.00	1.19	1.00	0.84
5000K	0.96	1.12	1.04	0.89

SQUERO COMBINATION

RECESSED PATTERN

STATIC WHITE



AAM MODULE

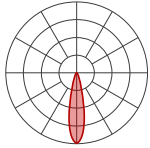

AAM 21°

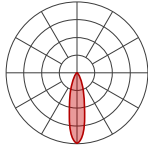

AAM 30°

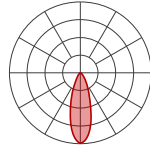

AAM 36°

DELIVERED LUMENS

Wattage	5.0									
CRI	80+					90+				
CCT	2700K	3000K	3500K	4000K	5000K	2700K	3000K	3500K	4000K	5000K
Lumen	323	340	350	357	364	265	279	289	299	312
Wattage	8.0									
CRI	80+					90+				
CCT	2700K	3000K	3500K	4000K	5000K	2700K	3000K	3500K	4000K	5000K
Lumen	553	583	600	612	624	454	478	495	513	534

MICRO SPOT MODULE

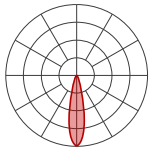

Micro Spot 25°

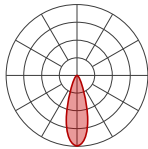

Micro Spot 35°

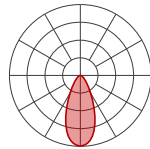

Micro Spot 50°

DELIVERED LUMENS

Wattage	5.0									
CRI	80+					90+				
CCT	2700K	3000K	3500K	4000K	5000K	2700K	3000K	3500K	4000K	5000K
Lumen	373	400	400	432	432	324	344	344	345	372

SQUERO COMBINATION

RECESSED PATTERN

STATIC WHITE



BIOS

Three BIOS Circadian LED solutions are offered – Biological Static, Biological Dynamic, and Biological Tunable. Use the decision tree below to identify when and where to use BIOS Wellness LED Lighting Solutions.

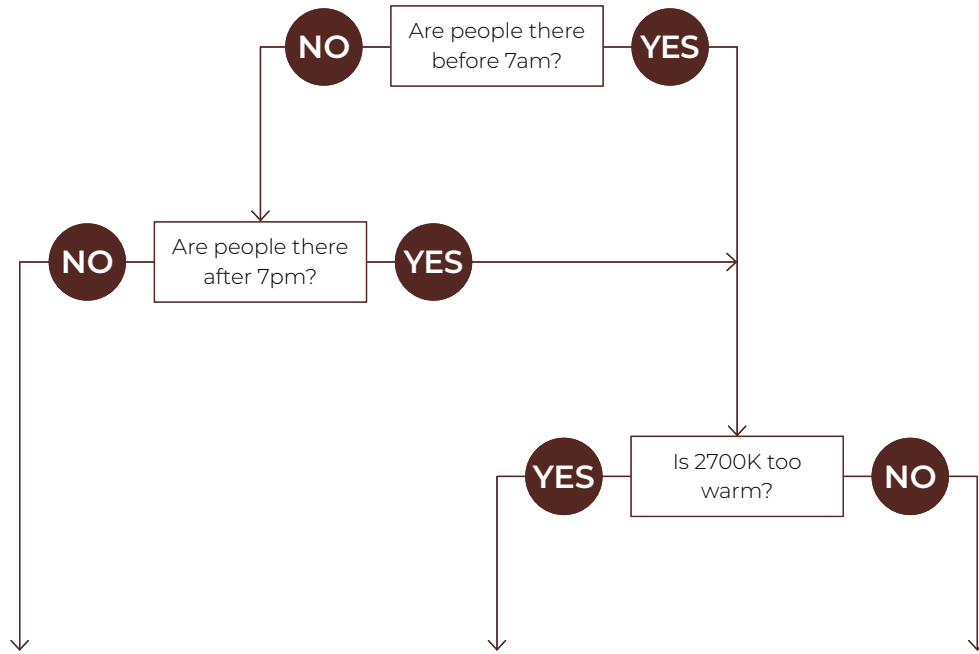

Biological Static BIOSST	Biological Dynamic BIOSDY	Biological Tunable BIOSTU
No CCT change when dimmed e.g. 40K - 4000K stays as 4000K when dimmed	500K shift when dimmed e.g. 40K - 4000K changes to 3500K when dimmed	Dims to 2700K e.g. 40K - 4000K changes to 2700K when dimmed
Daytime solution	Daytime + evening solution	Daytime + evening solution
Spaces in operation during daytime hours, between 7am and 7pm	Spaces in operation overnight, after 7pm and before 7am, and when CCT color shift in the evening is not preferred	Suitable for spaces in operation overnight, after 7pm and before 7am, and where people do not sleep (CCT color shift in the evening is preferred)
E.g. offices, medical/dental offices	E.g. hospitals	E.g. offices, shiftwork

SQUERO COMBINATION

RECESSED PATTERN

STATIC WHITE



Technical Specifications

OPTICS

Miniature Reflector Optic (MRO)

Locates individual, precisely molded TIR elements over each LED emitter, and further shield the source with precise parabolic reflectors. The controlled beam is remarkably comfortable – especially in a small LED luminaire.

MRO is available in a specular black or gloss white finish and creates a distinctive visual texture.

Different TIR elements offer a choice of beam spreads: narrow (18° with SC of 0.3), medium (35° with SC of 0.6), and wide (55° with SC of 0.9). These concentrated distributions can provide effective task illumination in a variety of applications.

Each MRO module is 6" long with five optical chambers.



Parabolic Louvers (MBPL, MPL & SPL)

Parabolic Louver Optics provide excellent shielding and a pleasing crisp visual texture. The precisely molded louvers consist of 1" deep blades and side reflectors with shielding of 50° lengthwise and 45° crosswise.

The parabolic contour of the blades and side reflectors direct light into a comfortable downlight distribution with a spacing criterion of 1.1, while minimizing shadows from the LED array above each cell.

Three finishes are available: matte black, matte, and specular. Specular (SPL) provides higher efficacy, sharper cut-off, and an ultra quiet appearance at shallow viewing angles. Matte (MPL) offers a softer appearance, a wider beam spread, and gentle brightness transition at cut-off. Matte black (MBPL) offers the lowest UGR in Squero as the black parabolic louver is very quiet and glare free. The UGR is the best in class rating of under 10.



High-Efficiency Lambertian Optic (HLO)

The High-Efficiency Lambertian Optic (HLO) shielding of diffusing 0.075" thick acrylic with up to 88% transmission and good source obscuration is combined with matte white side reflectors to create an efficient optical chamber with uniform luminosity.

Luminaire brightness is controlled by the flux-to-shielding area ratio. For visual comfort, avoid high lumen output unless Squero is installed in a high ceiling application. Spacing criteria: 1.2 (longitudinal) x 1.1 (lateral).



Blank (BLA)

Blank covers provide spacing – functional or rhythmic – in the direct component of a Squero Combination luminaire. Covers are sized according to the Combination design, finished to match the luminaire housing, and snap into the aperture.



LIGHT SOURCE

Static white

Custom linear array of high-flux LEDs mounted onto aluminum-backed circuitry with quick-connect wiring to facilitate service and optimize thermal management. Available in 2700K, 3000K, 3500K, 4000K, and 5000K with a minimum 80+ CRI and an option for 90+ CRI with elevated R9 value. Color consistency maintained to within 3 SDCM. All LEDs have been tested in accordance with IESNA LM-80-08 and the results have shown L80 lumen maintenance greater than 60,000 hours. Absolute product photometry is measured and presented in accordance with IESNA LM-79, unless otherwise indicated.

BIOS

BIOS SkyBlue™ Technology is designed to provide the specific circadian stimulus to improve overall sleep quality, recovery during the night, and overall feelings of well-being.

The non-visual light signals that stimulate our circadian system have peak intensity in the "sky blue" region. As the diagram below illustrates, BIOS SkyBlue technology shifts the peak LED spectral intensity (490 nm) to align better with the peak response of circadian stimulus. Also note the enhanced deep-red (near 660 nm) spectrum.

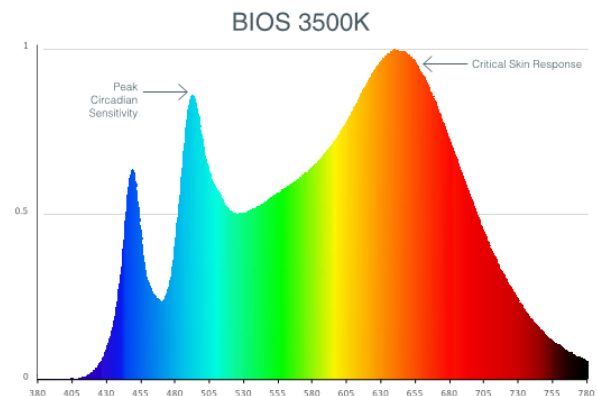

Three BIOS solutions are offered: BIOS Biological Static (BIOSST), BIOS Biological Dynamic (BIOSDY), and BIOS Biological Tunable (BIOSTU). See page 8 for details.

SQUERO COMBINATION

RECESSED PATTERN

STATIC WHITE



PATTERN LENGTH

All individual sections are joined together onsite using the joiner kits provided. Lumenwerx offers joiner kits that are extremely simple to work with in the field and result in a fixture that appears virtually seamless with no light leak at any connection.

ELECTRICAL

Factory-set, adjustable output current LED driver with universal (120-277 VAC) input. Dimmable from 100% to 1% with 0-10V dimming control. Rated life (90% survivorship) of 50,000 hours at 50°C max. ambient (and 70°C max. case) temperature. At maximum driver load: Efficiency > 84%, PF > 0.9, THD < 20%. Other specifiable options include Lutron Hi-Lume 1% Eco, eidoLED 1% ECOdrive 0-10V, eidoLED 0.1% SOLOdrive 0-10V, ELV, TRIAC, and DALI protocol drivers. All of our standard 0-10V drivers are NEMA 410 compliant.

PoE

Depending on the PoE manufacturer selected, Lumenwerx will install the node in factory as either integral to the luminaire or as a remote module. Factory programming of the PoE node may or may not enable the following functionalities: lumen package, DUO (tunable white), QUADRO (RGBW), emergency battery backup, and sensor integration. These must be addressed and evaluated on a case-by-case basis.

ELECTRICAL SECTION OPTIONS

Electrical section options are available for fixtures specified as multi circuit (#MC). With MC, specify the total number of circuits (#), including any circuits required for optional electrical sections. A drawing is required to specify the layout. Please consult factory for custom configurations.

Electrical sections

Options include emergency-powered (#EC##), night light (#NL##), daylight (#DL##), and generator transfer device (#GTD##) sections. Specify the quantity (#), as well as the section length in inches (##).

Example 1: A 32' Direct fixture with two 8' emergency-powered sections on a second circuit.

Code: 2MC-2EC96

Example 2: A 24' Direct fixture with one 4' generator transfer device section.

Code: 1MC-1GTD48

Battery

Each emergency battery (#EMB) powers a 4' section. All batteries will be on the same circuit. Specify the number of batteries (#) required.

Factory installed long life, high temperature, maintenance-free Lithium-Ion battery pack with self-test functionality, test switch and charge indicator. Minimum of 90 minutes operation, up to 1000 lumens per 4' (25°C) emergency lighting output and recharge time of 24 hours.

MOUNTING

Recessed fixtures can be mounted into exposed or concealed T-bar or tegular ceiling, as well as in ceilings with trim, trimless, or mud flange options.

FINISH

Interior: 95%, reflective matte powder coated white paint

Exterior: Matte white, matte black, or aluminum powder coating. Custom finishes are also available.

CONTROLS

Lumenwerx offers several options for integrating occupancy and daylight harvesting controls in our luminaires.

For latest information on sensors, click [here](#).



Standalone controls

An integrated standalone sensor controls the luminaire in which it is installed. Depending on the length, more than one sensor may be necessary and may control the entire luminaire, or just a section of it. These controls operate independently. Unless otherwise agreed, sensor location, blank size, and functionality of the sensor within the luminaire are selected by Lumenwerx. See client drawings for details.

Three types are available:

OMS: An integral Passive InfraRed (PIR) sensor turns luminaires on and off automatically with field-adjustable time out period. No wall control is used. Coverage pattern for large motion has a 12' diameter with the sensor mounted 8' above the floor; for small motion, the pattern has an 8' diameter. Typically, one sensor is required for every 10' of a continuous luminaire run.

ODS: An integral, daylight harvesting sensor with closed-loop operation dims the luminaire in which it is installed in order to compensate for available daylight. The sensor measures the combination of daylight and luminaire light reflected from horizontal surfaces below the luminaire. Initial onsite calibration is required via the use of provided remote control.

OCS: Both an occupancy and a daylight sensor are installed in the luminaire.

SQUERO COMBINATION

RECESSED PATTERN

STATIC WHITE



Connected controls

With connected controls, sensors or nodes installed in the luminaire form part of a larger control system infrastructure from manufacturers such as: Lutron, Encelium, Cooper Wavelinx, Acuity nLight, Casambi, Legrand, and others. These connected controls allow for a scalable system providing features like occupancy and daylight control, manual control, scheduling and configuration of various zones and scenes. Energy reporting and system monitoring are also possible. Specific capabilities depend on the control system being used.

Lumenwerx installs the components (sensors, nodes, power packs, etc) which may be supplied to us by a third party, or procured directly by Lumenwerx, depending on the control system manufacturer.

Lumenwerx is solely responsible for the installation of specified components; the controls manufacturer is responsible for performance of the control system.

To indicate a Lumenwerx luminaire with connected controls, identify the specific onsite control system to be integrated into the luminaires using the ordering code. Due to the diversity of components, you must contact factory to assure complete compatibility with intended control system and to fully specify the luminaire.

Complete control specifications, sensor/node/power pack layout, and narrative for the control system are required for Lumenwerx to create shop drawings and submittals.

INTEGRATED TRACK

The integrated track is available with single units and continuous runs, with or without sections of integrated LED. Two options are available: one supplied and installed by Lumenwerx, and the other by others and installed by Lumenwerx. Detailed specifications of the track system must be supplied. Consult factory for details.

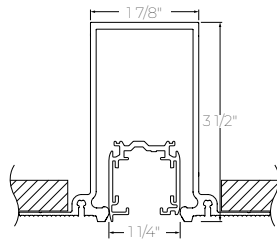
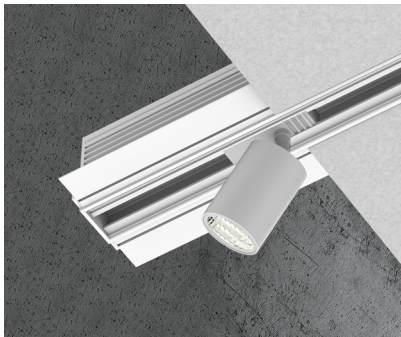

ADJUSTABLE ACCENT MODULE

The Adjustable Accent Module (AAM) features a $\varnothing 1\ 9/16"$ x $3\ 1/4"$ cylinder that rotates 360° and tilts 90° . The LED light source is coupled with TIR optics to provide beam angles of 21° , 30° , and 36° while producing up to 600 lumens. LED light source CCT options are 2700K, 3000K, 3500K, 4000K, and 5000K, available in either 80+ CRI or 90+ CRI.

The AAM module can be selected in either a white or black finish and a honeycomb louver accessory is also available. The AAM driver is mounted above the cylinder, inside the SQUERO housing and accepts universal input voltage (120-277 VAC) while providing 0-10V dimming control.

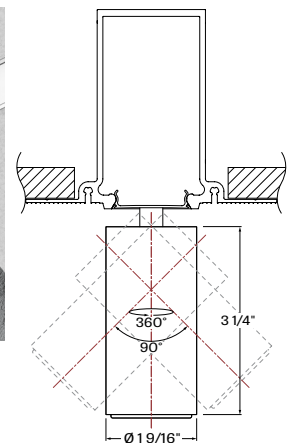
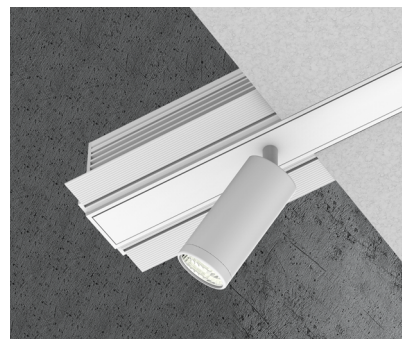

MICRO SPOT MODULE

The Micro Spot is a $\varnothing 7/8"$ x $1\ 5/16"$ adjustable spotlight that extends, retracts, rotates 360° , and tilts 90° . Its LED light source is coupled with a TIR refractor to provide beam angles of 25° , 35° , and 50° , while producing up to 400 lumens. LED light source CCT options are 2700K, 3000K, 3500K, 4000K, and 5000K, available in either 80+ CRI or 90+ CRI. The Micro Spot is offered in a white or black finish. The Micro Spot driver is mounted within the luminaire housing and accepts universal input voltage (120-277 VAC) with 0-10V dimming control.

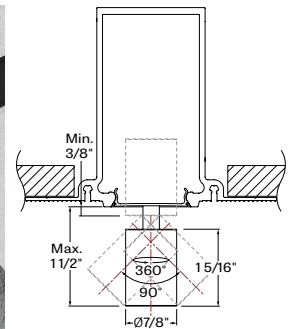
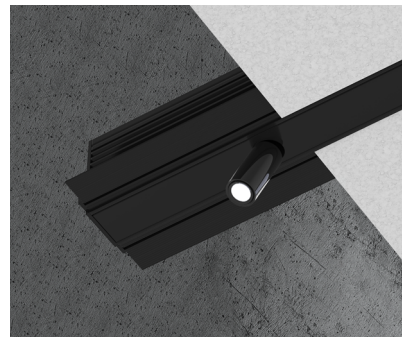

SQUERO COMBINATION

RECESSED PATTERN

STATIC WHITE



CONSTRUCTION

Housing: Extruded aluminum, up to 90% recycled content

Interior brackets: Die-formed cold rolled steel sheet

Joining system: Die-cast aluminum

Louvers: Injection molded optical grade polycarbonate, up to 95% reflective

Recessed flanges: Extruded aluminum, up to 90% recycled content

End plate: Die-formed cold rolled steel sheet

CERTIFICATIONS

ETL: Rated for indoor dry/damp locations. Conforms to UL Standard 1598 and certified to CAN/CSA Standard C22.2 No. 250.0.

Declare: [LBC Red List Approved](#)

WARRANTY

Lumenwerx provides a five-year limited warranty on electrical and mechanical performance of the luminaires, including the LED boards, drivers, and auxiliary electronics. Lumenwerx will repair or replace defective luminaires or components at our discretion, provided they have been installed and operated in accordance with our specifications. Other limitations apply, please refer to the full warranty on our website.