

SQUERO

PENDANT
STATIC WHITE, BIOS

LUMENWERX



Project: _____

Type: _____

DESCRIPTION

Squero brings style and flexibility to linear lighting systems. Less than 2" wide, Squero offers a variety of optics, each providing a different visual texture, as well as photometric performance. Optional modules are also available for accent lighting. Squero can be installed as individual luminaires or in continuous runs. See separate spec sheets for Combinations and Patterns, where various optics can be combined in a single fixture.

SENSORS
For latest information on sensors, click [here](#).



Up to 145 lm/W performance

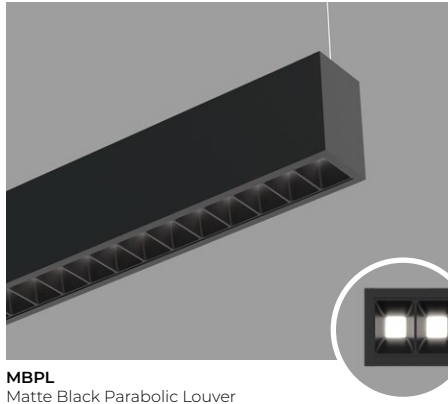

MBPL
Matte Black Parabolic Louver

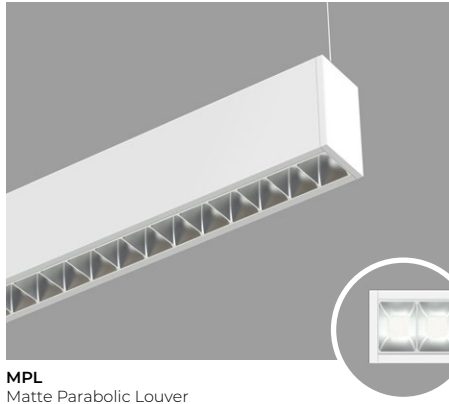

MPL
Matte Parabolic Louver

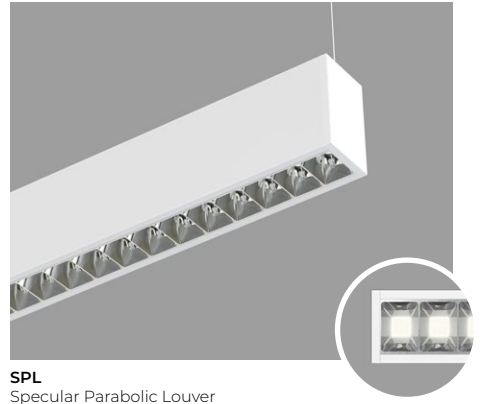

SPL
Specular Parabolic Louver

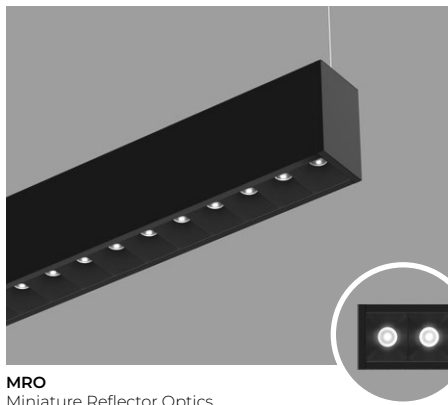

MRO
Miniature Reflector Optics

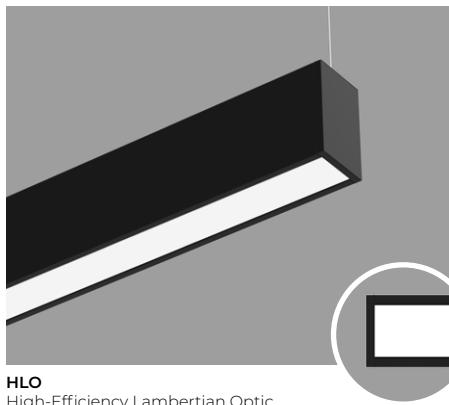

HLO
High-Efficiency Lambertian Optic

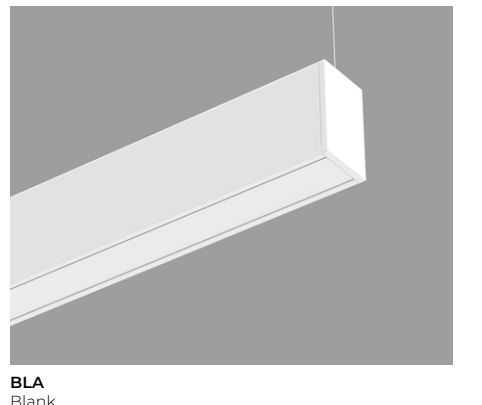

BLA
Blank

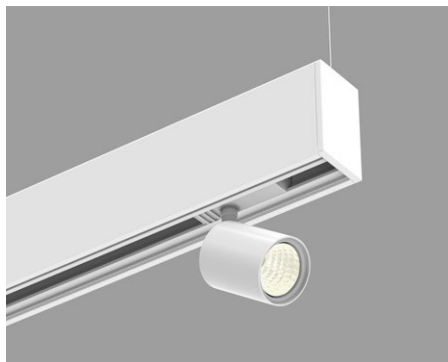

ITR¹
Integrated Track

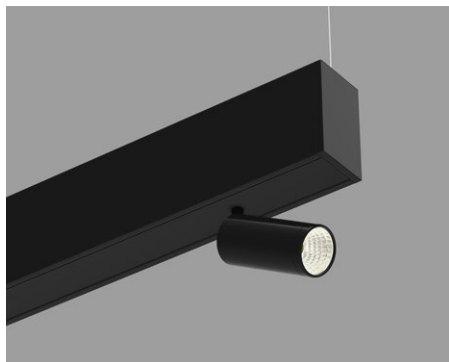

AAM
Adjustable Accent Module

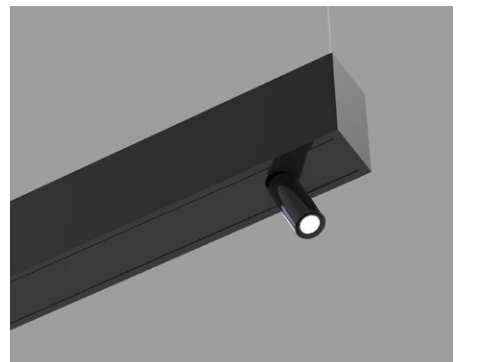

MS
Micro Spot

¹Track and downlight by others.



SQUERO

PENDANT
STATIC WHITE, BIOS

LUMENWERX

Project: _____

Type: _____

Order Guide

LUMINAIRE ID	DISTRIBUTION	DIRECT OPTIC	MRO COLOR	INDIRECT OPTIC Specify NA for Direct fixture	LIGHT SOURCE ⁶
SQUP					
SQUP - Squero Pendant	DI - Direct/Indirect D - Direct	MRO18 - 18 degree Miniature Reflector Optic MRO35 - 35 degree Miniature Reflector Optic MRO55 - 55 degree Miniature Reflector Optic MBPL ¹ - Matte Black Parabolic Louver MPL ¹ - Matte Parabolic Louver SPL ¹ - Specular Parabolic Louver HLO - High-Efficiency Lambertian Optic BLA ^{2,3} - Blank ¹ Not available with BIOSTU. ² Specify with AAM or Micro Spot option. ³ Can also be specified as the direct optic option for a Direct/Indirect fixture.	WH ⁴ - White BK ⁴ - Black NA - Not applicable ⁴ Only available with MRO optics.	WIO2 - Widespread Indirect Optic TIO ⁵ - Translucent Indirect Optic WAI2 ⁵ - Widespread Asymmetric Indirect Optic NA - Not applicable ⁵ Not available with BIOS.	SW - Static white BIOST7 - BIOS Biological Static BIOSDY7 - BIOS Biological Dynamic BIOSTU7 - BIOS Biological Tunable ⁶ Chromawerx Sola and Duo also available. Consult other spec sheet. ⁷ See page 7 for details.

CRI	DIRECT LUMEN PACKAGE	INDIRECT LUMEN PACKAGE Specify NA for Direct fixture	COLOR TEMP.	LUMINAIRE LENGTH	VOLTAGE
80CRI - 80 CRI 90CRI ⁸ - 90 CRI ⁸ Not available with BIOS.	350LMF - Eco low output 350 lm/ft 500LMF - Low output 500 lm/ft 750LMF - Medium output 750 lm/ft 1000LMF ^{9,10} - High output 1000 lm/ft ⁹ Not available with MBPL optic. ¹⁰ Not available with BIOS.	350LMF - Eco low output 350 lm/ft 500LMF - Low output 500 lm/ft 750LMF - Medium output 750 lm/ft 1000LMF ^{11,12,13} - High output 1000 lm/ft NA - Not applicable ¹¹ Not available with WAI2. ¹² For Direct/Indirect, Direct must not exceed 750 lm/ft. ¹³ Not available with BIOS.	27K ¹⁴ - 2700K 30K - 3000K 35K - 3500K 40K - 4000K 50K ¹⁴ - 5000K ¹⁴ Not available with BIOS.	#FT#IN ^{15,16} - Specify nominal length (#) in 1' and/or 1" increments Standard nominal lengths: Single units: 2' to 12' Continuous runs: lengths over 12' ¹⁵ Minimum 4' for Direct/Indirect, minimum 2' for Direct. ¹⁶ MROs are available in 6" increments, Parabolic Louvers in 1" increments, HLO and Blank in 1" increments.	120V - 120V 277V - 277V UNV - 120V-277V 347V ¹⁷ - 347V ¹⁷ Available with D1 driver only.

DRIVER ¹⁸	ELECTRICAL	ELECTRICAL SECTIONS (optional) ^{24,25}	MOUNTING ³⁰
DI - 1% 0-10V DA ¹⁹ - DALI LDEI ¹⁹ - Lutron Hi-lume 1% Eco ELD1 - eldoLED 1% ECOdrive 0-10V ELDO - eldoLED 0.1% SOLOdrive 0-10V ¹⁸ PoE (Power-over-Ethernet) compatible. Consult factory for details. ¹⁹ On-site commissioning is required.	1C - 1 circuit 2C ²⁰ - 2 circuits #MC ²¹ - Multi circuit EC - Emergency-powered fixture NL - Night light fixture DL - Daylight fixture GTD ^{22,23} - Generator transfer device fixture ²⁰ Available for Direct/Indirect only. Separate direct and indirect circuits. ²¹ Specify total number of circuits (#), including any required for electrical section, AAM or Micro Spot options. Provide drawing or layout specifications. Minimum 4' section per circuit. ²² Minimum 4' fixture. ²³ Not available with 347V.	#EC## ²⁶ - Emergency-powered section #NL## ²⁶ - Night light section #DL## ²⁶ - Daylight section #GTD## ^{26,27,28} - Generator transfer device section #EMB ^{28,29} - Emergency battery NA - None ²⁴ Specify with multi circuit (#MC) electrical option only. ²⁵ Provide drawing or layout specifications. Consult factory for other configurations. Default section length is 4'. ²⁶ Specify quantity (#), and section length in inches (##). ²⁷ Minimum 4' section. ²⁸ Not available with 347V. ²⁹ Specify quantity (#). All batteries will be on the same circuit. Each battery powers a 4' section. For Direct/Indirect, minimum 8' fixture.	ACS - Aircraft cable, standard STS - Stem, standard ACC() - Aircraft cable, custom STC() - Stem, custom ³⁰ See page 3 for ordering details.

FINISH ³¹	CONTROL ³²	OPTIONS	MODULE (optional) ^{40,41}
W - Matte white AL - Aluminum B - Matte black CF# - Custom finish, specify RAL# ³¹ Blank finish will match fixture finish.	STANDALONE CONTROLS ^{33,34} Specify the quantity (#) of sensors per fixture. #OMS ³⁵ - Onboard Occupancy #OMS## ³⁶ - Onboard Occupancy with bi-level dimming #ODS - Onboard Daylight #OCS - Onboard Occupancy & Daylight CONNECTED CONTROLS ³⁷ LU - Lutron AWN - Lutron Athena Wireless Node RF Only AWNS - Lutron Athena Wireless Node Sensor EN - Enlighted ENC - Encelium WL - Cooper Wavelinx AN - Acuity nLight CA - Casambi LG - Legrand NA - None ³² Standalone and connected control options cannot be combined. ³³ Available with D1 driver and 1 circuit options only. ³⁴ Minimum 4' per zone. Provide control zone length. ³⁵ Fixture turns off when no occupancy. ³⁶ Fixture dims to specified light level % (##). ³⁷ Consult factory for connected controls.	FU120 - Fuse 120V FU277 - Fuse 277V ITR ³⁸ - Integrated track CTB9 ³⁹ - T-bar caddy clip, 9/16" CTB15 ³⁹ - T-bar caddy clip, 15/16" CTG9 ³⁹ - Tegular caddy clip, 9/16" CTG15 ³⁹ - Tegular caddy clip, 15/16" CST ³⁹ - Screw slot caddy clip NA - None ³⁸ Consult factory for details. ³⁹ Available with aircraft cable only.	#AAM21() - AAM 21° #AAM30() - AAM 30° #AAM36() - AAM 36° #MS25() - Micro Spot 25° #MS35() - Micro Spot 35° #MS50() - Micro Spot 50° NA - None ⁴⁰ See page 3 for ordering details. ⁴¹ If more than one option is specified, separate codes with a "+", e.g. 1AAM21(...)+MS25(...)

PENDANT
STATIC WHITE, BIOS

Module

For a module, specify the options in the parentheses.

Example: 1AAM21(SW-80CRI-350LM-27K-W-NA)

MODULES (optional)								
MODULES ^{1,2,3}	LIGHT SOURCE	CRI	LUMEN PACKAGE	COLOR TEMP.	FINISH	OPTION		
#AAM21() - AAM 21° #AAM30() - AAM 30° #AAM36() - AAM 36° NA - None ¹ Specify quantity (#). ² 6" blank per module. ³ If more than one option is specified, separate codes with a "+", e.g. 1AAM21(...)+1MS25(...).	#MS25() - Micro Spot 25° #MS35() - Micro Spot 35° #MS50() - Micro Spot 50°	SW - Static white	80CRI - 80 CRI 90CRI - 90 CRI	AAM ⁴ 350LM - 350 lm 600LM - 600 lm ⁴ 5 W for 350 lm and 8 W for 600 lm. Wattages are for reference only. May change based on driver.	MS ⁵ 400LM - 400 lm ⁵ 5 W. Wattage is for reference only. May change based on driver.	27K - 2700K 30K - 3000K 35K - 3500K 40K - 4000K 50K - 5000K	W - Matte white B - Matte black	HCL ⁶ - Honeycomb louver NA - None ⁶ Not available with Micro Spot.

Pendant Mounting Code

Standard

For a standard mounting, please refer to the information below.

MOUNTING	
ACS - Aircraft cable, standard	STS - Stem, standard
Ø5" for power canopy Ø3" for non-power Canopies are white Power cord is white for all fixture finishes (except black fixture is black power cord) Aircraft cable length is 36"	Ø5" for power canopy Ø5" for non-power Canopies are white Stem finish is the same color as fixture Stem length is 18" Stem is not field adjustable

Custom

Aircraft Cable

For a custom mounting, specify the options in the parentheses.

Example: ACC(3NPC-72IN-W-PCB-SLC)

MOUNTING					
ACC()					
	NON-POWER CANOPY SIZE	AIRCRAFT CABLE LENGTH	CANOPY FINISH	POWER CORD COLOR	OPTIONS
ACC	3NPC - Ø3" non-power canopy 5NPC - Ø5" non-power canopy	36IN - 36" 72IN - 72" 120IN - 120" #IN ¹ - Other lengths, specify in inches ¹ Maximum length is 288". For longer lengths, please consult factory.	W - Matte white AL - Aluminum B - Matte black CF# - Custom finish, specify RAL#	PCW - White PCB - Black	SEM - Seismic mounting SLC - Sloped ceiling for aircraft cable NA - None

Stem

For a custom mounting, specify the options in the parentheses.

Example: STC(5NPC-36IN-W-STW-SLS)

MOUNTING					
STC()					
	NON-POWER CANOPY SIZE	STEM LENGTH	CANOPY FINISH	STEM COLOR	OPTIONS
STC	5NPC - Ø5" non-power canopy	18IN - 18" 36IN - 36" #IN ² - Specify length in inches ² Minimum length is 6". Maximum length is 72". Stem is not field adjustable.	W - Matte white AL - Aluminum B - Matte black CF# - Custom finish, specify RAL#	STW - Matte white STAL - Aluminum STB - Matte black STCF# - Custom finish, specify RAL#	SLS - Sloped ceiling for stem NA - None

SQUERO

LUMENWERX

PENDANT
STATIC WHITE, BIOS

Dimensions

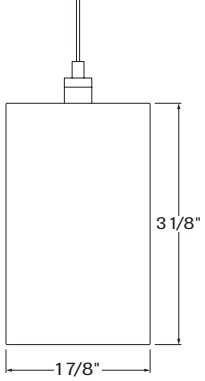

Section Views

DIRECT OPTICS

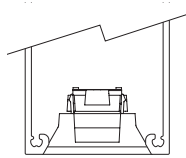

MRO

Miniature Reflector Optic

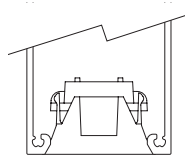

MBPL, MPL & SPL

Matte Black, Matte & Specular
Parabolic Louver

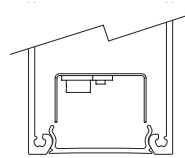

HLO

High-Efficiency Lambertian
Optic

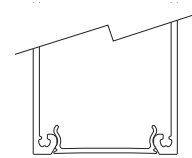

BLA

Blank

INDIRECT OPTICS

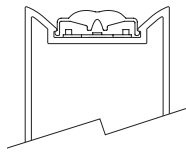

WIO2

Widespread Indirect Optic

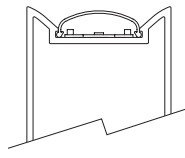

TIO

Translucent Indirect Optic

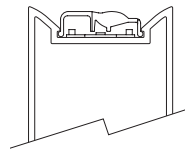

WAI2

Widespread Asymmetric
Indirect Optic

PENDANT
STATIC WHITE, BIOS

Photometrics

Values calculated based on a 4ft fixture at 35K and 80 CRI for all optics.

DIRECT OPTICS

MRO18

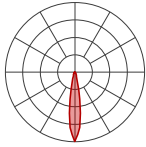

LM/FT	W/FT	LPW
350	2.7	130
500	4.0	125
750	6.4	118
1000	9.1	110

MRO35

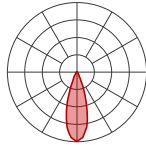

LM/FT	W/FT	LPW
350	2.9	121
500	4.3	116
750	6.9	108
1000	9.9	101

MRO55

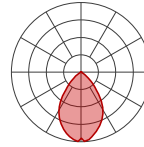

LM/FT	W/FT	LPW
350	3.2	109
500	4.8	104
750	7.7	97
1000	11.0	91

HLO

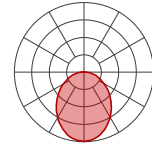

LM/FT	W/FT	LPW
350	3.1	112
500	4.6	108
750	7.3	103
1000	10.2	98

MBPL

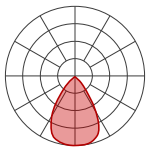

LM/FT	W/FT	LPW
350	5.2	67
500	7.5	66
750	11.7	64

MPL

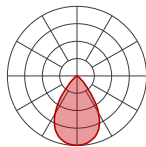

LM/FT	W/FT	LPW
350	3.5	99
500	5.1	98
750	7.7	98
1000	10.6	95

SPL

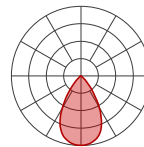

LM/FT	W/FT	LPW
350	3.1	113
500	4.4	113
750	6.7	112
1000	9.1	109

MULTIPLIER TABLES - CCT/CRI

Use these tables to get results for different color temperatures and CRI for all Direct and Indirect photometric tables.

MRO18 / MRO35 / MRO55

CCT (K)	WATTS		LPW	
	CRI 80	CRI 90	CRI 80	CRI 90
2700	1.04	1.19	0.96	0.84
3000	1.00	1.15	1.00	0.87
3500	1.00	1.12	1.00	0.89
4000	0.99	1.10	1.01	0.91
5000	0.94	1.06	1.06	0.94

MBPL / MPL / SPL

CCT (K)	WATTS		LPW	
	CRI 80	CRI 90	CRI 80	CRI 90
2700	1.04	1.19	0.96	0.84
3000	1.00	1.15	1.00	0.87
3500	1.00	1.12	1.00	0.89
4000	0.99	1.10	1.01	0.91
5000	0.94	1.06	1.06	0.94

HLO

CCT (K)	WATTS		LPW	
	CRI 80	CRI 90	CRI 80	CRI 90
2700	1.05	1.27	0.95	0.79
3000	1.02	1.23	0.98	0.81
3500	1.00	1.19	1.00	0.84
4000	1.00	1.19	1.00	0.84
5000	0.96	1.12	1.04	0.89

SQUERO

LUMENWERX

PENDANT
STATIC WHITE, BIOS

Values calculated based on a 4ft fixture at 35K and 80 CRI for all optics.

INDIRECT OPTICS

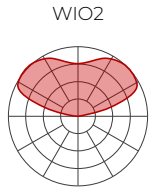

LM/FT	W/FT	LPW
350	2.4	145
500	3.5	141
750	5.5	136
1000	7.7	130

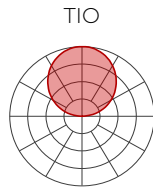

LM/FT	W/FT	LPW
350	2.8	127
500	4.0	124
750	6.3	119
1000	8.8	114

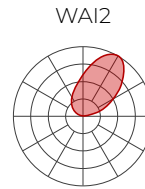

LM/FT	W/FT	LPW
350	2.5	139
500	3.7	135
750	5.8	130

MULTIPLIER TABLES - CCT/CRI

Use these tables to get results for different color temperatures and CRI for all Direct and Indirect photometric tables.

WIO2 / TIO / WAI2

CCT (K)	WATTS		LPW	
	CRI 80	CRI 90	CRI 80	CRI 90
2700	1.05	1.27	0.95	0.79
3000	1.02	1.23	0.98	0.81
3500	1.00	1.19	1.00	0.84
4000	1.00	1.19	1.00	0.84
5000	0.96	1.12	1.04	0.89

DIRECT/INDIRECT - LPW CALCULATION

For Direct/Indirect performance values, follow the formula.

$$\left(\frac{\text{DIRECT LM/FT} + \text{INDIRECT LM/FT}}{\text{DIRECT W/FT} + \text{INDIRECT W/FT}} \right) = \text{LPW}$$

AAM

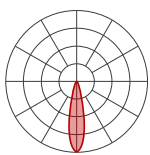

AAM 21°

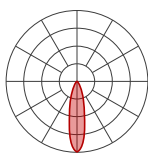

AAM 30°

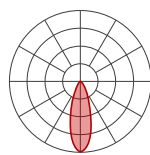

AAM 36°

DELIVERED LUMENS

Wattage	5.0									
	80					90				
CRI	2700K	3000K	3500K	4000K	5000K	2700K	3000K	3500K	4000K	5000K
Lumen	323	340	350	357	364	265	279	289	299	312
Wattage	8.0									
	80					90				
CRI	2700K	3000K	3500K	4000K	5000K	2700K	3000K	3500K	4000K	5000K
Lumen	553	583	600	612	624	454	478	495	513	534

MICRO SPOT

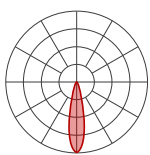

Micro Spot 25°

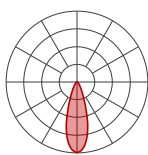

Micro Spot 35°

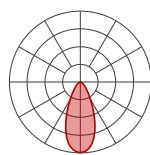

Micro Spot 50°

DELIVERED LUMENS

Wattage	5.0									
	80					90				
CRI	2700K	3000K	3500K	4000K	5000K	2700K	3000K	3500K	4000K	5000K
Lumen	373	400	400	432	432	324	344	344	345	372

BIOS

Three BIOS Circadian LED solutions are offered – Biological Static, Biological Dynamic, and Biological Tunable. Use the decision tree below to identify when and where to use BIOS Wellness LED Lighting Solutions.

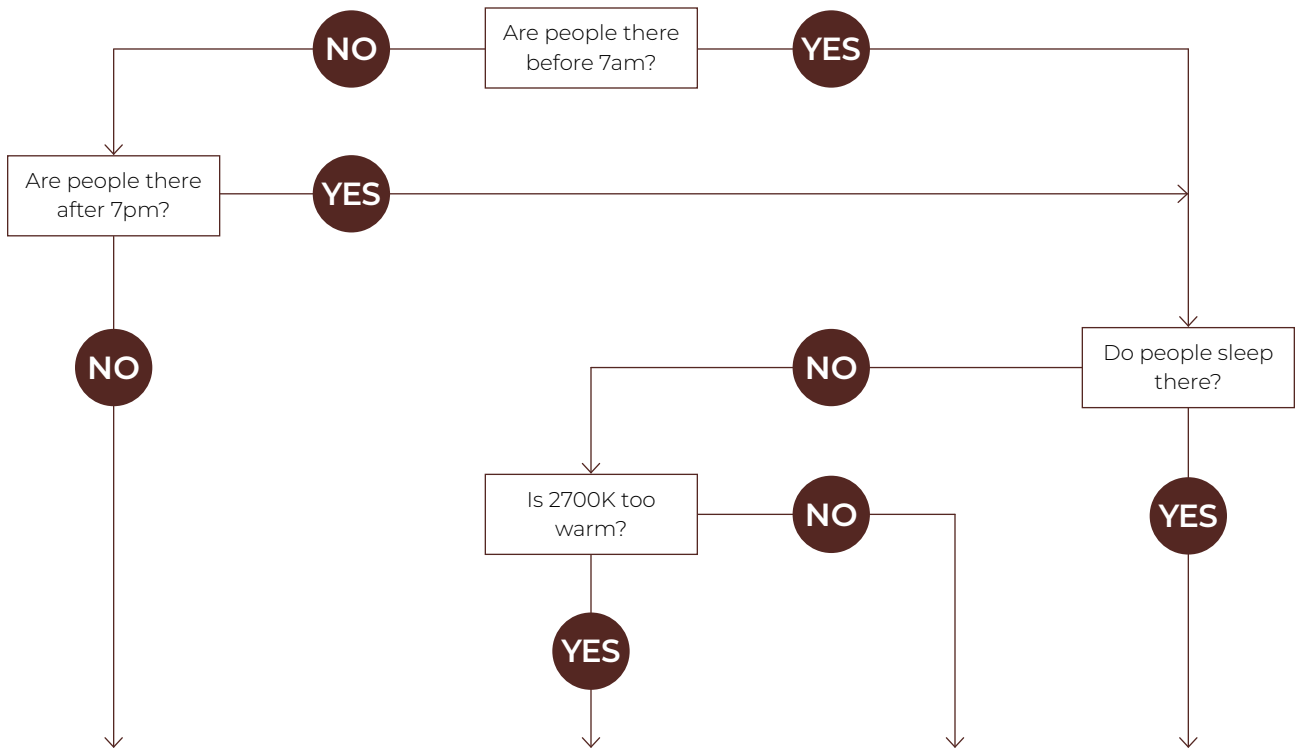

Biological Static BIOSST	Biological Dynamic BIOSDY	Biological Tunable BIOSTU
No CCT change when dimmed	500K shift when dimmed	Dims to 2700K
Daytime solution	Daytime + evening solution	Daytime + evening solution
Spaces in operation during daytime hours, between 7am and 7pm	Spaces in operation overnight, after 7pm and before 7am, and when CCT color shift in the evening is not preferred	Suitable for spaces in operation overnight, after 7pm and before 7am, and where people do not sleep (CCT color shift in the evening is preferred)
E.g. offices, medical/dental offices	E.g. hospitals	E.g. offices, shiftwork

Technical Specifications

DIRECT OPTICS

Miniature Reflector Optic (MRO)

Locates individual, precisely molded TIR elements over each LED emitter, and further shield the source with precise parabolic reflectors. The controlled beam is remarkably comfortable – especially in a small LED luminaire.

MRO is available in a specular black or gloss white finish and creates a distinctive visual texture.

Different TIR elements offer a choice of beam spreads: narrow (18° with SC of 0.3), medium (35° with SC of 0.6), and wide (55° with SC of 0.9). These concentrated distributions can provide effective task illumination in a variety of applications.

Each MRO module is 6" long with five optical chambers.



Parabolic Louvers (MBPL, MPL & SPL)

Parabolic Louver Optics provide excellent shielding and a pleasing crisp visual texture. The precisely molded louvers consist of 1" deep blades and side reflectors with shielding of 50° lengthwise and 45° crosswise.

The parabolic contour of the blades and side reflectors direct light into a comfortable downlight distribution with a spacing criterion of 1.1, while minimizing shadows from the LED array above each cell.

Three finishes are available: matte black, matte, and specular. Specular (SPL) provides higher efficacy, sharper cut-off, and an ultra quiet appearance at shallow viewing angles. Matte (MPL) offers a softer appearance, a wider beam spread, and gentle brightness transition at cut-off. Matte black (MBPL) offers the highest UGR in Squero as the black parabolic louver is very quiet and glare free. The UGR is the best in class rating of under 10.



High-Efficiency Lambertian Optic (HLO)

The High-Efficiency Lambertian Optic (HLO) shielding of diffusing 0.075" thick acrylic with up to 88% transmission and good source obscuration is combined with matte white side reflectors to create an efficient optical chamber with uniform luminosity.

Luminaire brightness is controlled by the flux-to-shielding area ratio. For visual comfort, avoid high lumen output unless Squero is installed in a high ceiling application. Spacing criteria: 1.2 (longitudinal) x 1.1 (lateral).



Blank (BLA)

Aluminum Blank covers provide spacing – functional or rhythmic – in the direct component of a Squero Combination luminaire.

Covers are sized according to the Combination design, finished to match the luminaire housing, and snap into the aperture.



INDIRECT OPTICS

Widespread Indirect Optic (WIO2)

The Widespread Indirect Optic (WIO2) is a horizontal LED array with a widespread indirect micro prismatic optic that offers an impressive 160° spread. WIO2 creates an even illumination for smooth brightness on the ceiling that can achieve uniformity ratios of up to 2:1.

Uniformity [max/min]

Based on 18' continuous runs, in a 20' x 40' room, 10' wall height

Mounting height from ceiling	Spacing (Center to center)		
	8'	10'	12'
12"	5.5	10.0	9.0
18"	6.5	6.0	6.0
24"	2.5	4.0	4.5

Translucent Indirect Optic (TIO)

The Translucent Indirect Optic (TIO) is composed of a horizontal LED array that has a translucent lens to mask pixilation from the diodes. TIO has a 100° spread in the indirect that is ideal when the fixture is mounted farther away from the ceiling.

Widespread Asymmetric Indirect Optic (WAI2)

The Widespread Asymmetric Indirect Optic (WAI2) offers an upward grazing effect with a 45° forward throw. It softly highlights the ceiling in the up-light while distributing the required illumination of the rest of an interior space. For avoiding glare and enjoying visual comfort, WAI2 is an ideal solution.

LIGHT SOURCE - STATIC WHITE

Custom linear array of high-flux LEDs mounted onto aluminum-backed circuitry with quick-connect wiring to facilitate service and optimize thermal management. Available in 2700K, 3000K, 3500K, 4000K, and 5000K with a minimum 80 CRI and an option for 90 CRI with elevated R9 value. Color consistency maintained to within 3 SDCM. All LEDs have been tested in accordance with IESNA LM-80-08 and the results have shown L80 lumen maintenance greater than 60,000 hours. Absolute product photometry is measured and presented in accordance with IESNA LM-79, unless otherwise indicated.

SQUERO

LUMENWERX

PENDANT

STATIC WHITE, BIOS

LIGHT SOURCE - BIOS

BIOS SkyBlue™ Technology is designed to provide the specific circadian stimulus to improve overall sleep quality, recovery during the night, and overall feelings of well-being. The non-visual light signals that stimulate our circadian system have peak intensity in the "sky blue" region. As the diagram below illustrates, BIOS SkyBlue technology shifts the peak LED spectral intensity (490 nm) to align better with the peak response of circadian stimulus. Also note the enhanced deep-red (near 660 nm) spectrum.

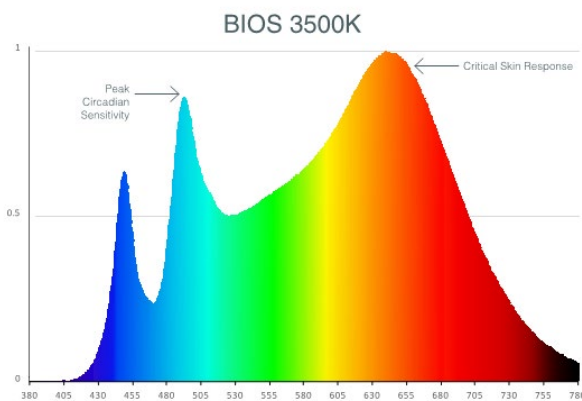

Three BIOS solutions are offered: BIOS Biological Static (BIOSST), BIOS Biological Dynamic (BIOSDY), and BIOS Biological Tunable (BIOSTU). See page 7 for details.

LUMINAIRE LENGTH

Squero is made up of standard 2 to 12 foot sections that may be joined together to create longer continuous run lengths. Exact run lengths must be noted in the product code. The minimum individual section available is 2 feet for Direct fixtures and 4 feet for Direct/Indirect fixtures.

All individual sections are joined together onsite using the joiner kits provided. Lumenwerx offers joiner kits that are extremely simple to work with in the field and result in a fixture that appears virtually seamless with no light leak at any connection.

ELECTRICAL

Factory-set, adjustable output current LED driver with universal (120-277VAC) input. Dimmable from 100% to 1% with 0-10V dimming control. Rated life (90% survivorship) of 50,000 hours at 50°C max. ambient (and 70°C max. case) temperature. At maximum driver load: Efficiency > 84%, PF > 0.9, THD < 20%. Other specifiable options include Lutron Hi-Lume 1% Eco, eidoLED 1% ECOdrive 0-10V, eidoLED 0.1% SOLOdrive 0-10V, and DALI protocol drivers. All of our standard 0-10V drivers are NEMA 410 compliant.

PoE

Depending on the PoE manufacturer selected, Lumenwerx will install the node in factory as either integral to the luminaire or as a remote module. Factory programming of the PoE node may or may not enable the following functionalities: lumen package, Duo (tunable white), emergency battery backup, and sensor integration. These must be addressed and evaluated on a case-by-case basis.

ELECTRICAL SECTION OPTIONS

Electrical section options are available for fixtures specified as multi circuit (#MC). With MC, specify the total number of circuits (#), including any circuits required for optional electrical sections. A drawing is required to specify the layout. Please consult factory for custom configurations.

Electrical sections

Options include emergency-powered (#EC##), night light (#NL##), daylight (#DL##), and generator transfer device (#GTD##) sections. Specify the quantity (#), as well as the section length in inches (##).

Example 1: A 32' Direct fixture with two 8' emergency-powered sections on a second circuit.

Code: 2MC-2EC96

Example 2: A 16' Direct/Indirect fixture with separate circuits for direct and indirect, and with one 4' night light section on the direct side on a third circuit.

Code: 3MC-1NL48

Example 3: A 24' Direct fixture with one 4' generator transfer device section.

Code: 1MC-1GTD48

Battery

Each emergency battery (#EMB) powers a 4' section. All batteries will be on the same circuit. Specify the number of batteries (#) required.

Factory installed long life, high temperature, maintenance-free Lithium-Ion battery pack with self-test functionality, test switch and charge indicator. Minimum of 90 minutes operation, up to 1000 lumens per 4' (25°C) emergency lighting output and recharge time of 24 hours.

SQUERO

LUMENWERX

PENDANT

STATIC WHITE, BIOS

MOUNTING OPTIONS

Fixtures can be pendant-mounted, using aircraft cables, or stem-mounted. Unless otherwise specified, Lumenwerx provides the following hardware:

Standard aircraft cable option (ACS) - Canopies are white, Ø3" for power canopy, Ø3" for non-power. Power cord is black for black fixtures, and white for all other fixture finishes. Aircraft cable length is 36".

Standard stem option (STS) - Canopies are white, Ø5" for both power and non-power. Stem finish is the same color as fixture. Stem length is 18". Stem is not field adjustable.

Caddy clips, if required specify under OPTIONS

For all other options, see the mounting code on page 3.

FINISH

Interior - 95%, reflective matte powder coated white paint

Exterior - Matte white, matte black, or aluminum powder coating. Custom finishes are also available.

CONTROLS

Lumenwerx offers several options for integrating occupancy and daylight harvesting controls in our luminaires.

For latest information on sensors, click [here](#).



STANDALONE CONTROLS

An integrated standalone sensor controls the luminaire in which it is installed. Depending on the length, more than one sensor may be necessary and may control the entire luminaire, or just a section of it. These controls operate independently. Unless otherwise agreed, sensor location, blank size, and functionality of the sensor within the luminaire are selected by Lumenwerx. See client drawings for details.

Three types are available:

OMS: An integral Passive InfraRed (PIR) sensor turns luminaires on and off automatically with field-adjustable time out period. No wall control is used. Coverage pattern for large motion has a 12' diameter with the sensor mounted 8' above the floor; for small motion, the pattern has an 8' diameter. Typically, one sensor is required for every 10' of a continuous luminaire run.

ODS: An integral, daylight harvesting sensor with closed-loop operation dims the luminaire in which it is installed in order to compensate for available daylight. The sensor measures the combination of daylight and luminaire light reflected from horizontal surfaces below the luminaire. Initial onsite calibration is required via the use of provided remote control.

OCS: Both an occupancy and a daylight sensor are installed in the luminaire.

CONNECTED CONTROLS

With connected controls, sensors or nodes installed in the luminaire form part of a larger control system infrastructure from manufacturers such as: Lutron, Enlighted, Encelium, Cooper Wavelinx, Acuity nLight, Casambi, Legrand, and others. These connected controls allow for a scalable system providing features like occupancy and daylight control, manual control, scheduling and configuration of various zones and scenes. Energy reporting and system monitoring are also possible. Specific capabilities depend on the control system being used.

Lumenwerx installs the components (sensors, nodes, power packs, etc) which may be supplied to us by a third party, or procured directly by Lumenwerx, depending on the control system manufacturer.

Lumenwerx is solely responsible for the installation of specified components; the controls manufacturer is responsible for performance of the control system.

To indicate a Lumenwerx luminaire with connected controls, identify the specific onsite control system to be integrated into the luminaires using the ordering code. Due to the diversity of components, you must contact factory to assure complete compatibility with intended control system and to fully specify the luminaire.

Complete control specifications, sensor/node/power pack layout, and narrative for the control system are required for Lumenwerx to create shop drawings and submittals.

OPTIONS

ITR - Integrated track (track and downlight by others)

Multiple track systems manufactured by others, are offered in Squero direct, in individual, or runs, with or without LED integrated sections. Detailed specifications of the track system must be supplied. For other mounting options (please consult factory).

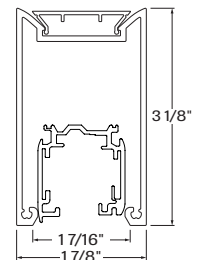
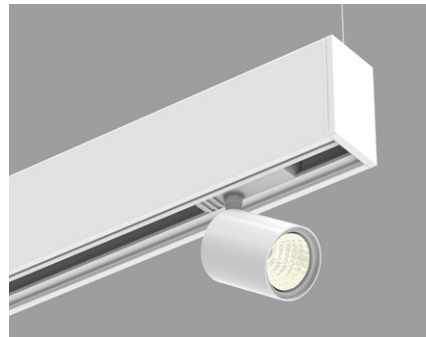

SQUERO

LUMENWERX

PENDANT

STATIC WHITE, BIOS

ADJUSTABLE LED ACCENT MODULE (AAM)

The Adjustable Accent Module (AAM) features a $\varnothing 1\ 9/16"$ x $3\ 1/4"$ cylinder that rotates 360° and tilts 90° . The LED light source is coupled with TIR optics to provide beam angles of 21° , 30° , and 36° while producing up to 600 lumens. LED light source CCT options are 2700K, 3000K, 3500K, 4000K, and 5000K, available in either 80 CRI or 90 CRI.

The AAM module can be selected in either a white or black finish and a honeycomb louver accessory is also available. The AAM driver is mounted above the cylinder, inside the SQUERO housing and accepts universal input voltage (120-277VAC) while providing 0-10V dimming control.

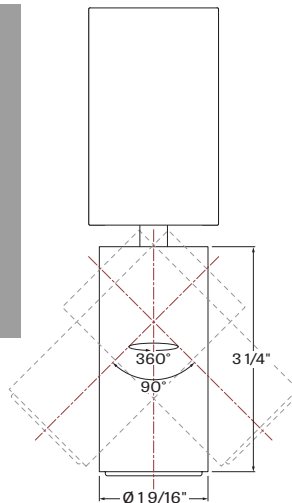
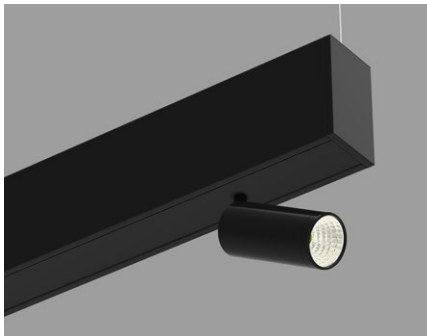

MICRO SPOT (MS)

The Micro Spot is a $\varnothing 7/8"$ x $1\ 5/16"$ adjustable spotlight that extends, retracts, rotates 360° , and tilts 90° . Its LED light source is coupled with a TIR refractor to provide beam angles of 25° , 35° , and 50° , while producing up to 400 lumens. LED light source CCT options are 2700K, 3000K, 3500K, 4000K, and 5000K, available in either 80 CRI or 90 CRI. The Micro Spot is offered in a white or black finish. The Micro Spot driver is mounted within the luminaire housing and accepts universal input voltage (120-277VAC) with 0-10 V dimming control.

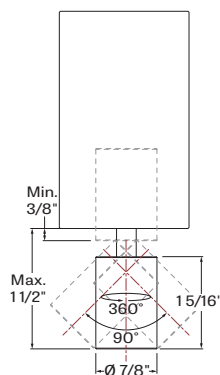
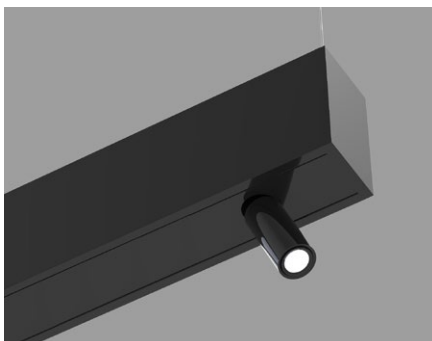

CONSTRUCTION

Housing - Extruded aluminum (0.100" nominal) up to 90% recycled content

Interior brackets - Die formed cold rolled sheet steel 10 gauge thick

Joining system - Die cast aluminum

Louvers - Injection molded optical grade polycarbonate (0.100" nominal) up to 95% reflective

Light guide - Clear PMMA laminated with microstructure film formed into optical TIR/extraction form

End caps - Die cast aluminum (0.125" nominal)

Hanger - Chromed griplock securely attached in end caps and/or joiners with stainless steel hardware

Aircraft cable suspension - 7x7 braids stainless steel air craft cable 0.05" thick

Stem - 0.5" diameter threaded steel tube matte white or aluminum powder coating. Custom finishes are also available

WEIGHT

4ft - 10.02 lbs - 4.54 kg

6ft - 15.18 lbs - 6.89 kg

8ft - 19.78 lbs - 8.97 kg

CERTIFICATION

ETL - Rated for Indoor Dry/Damp locations. Conforms to UL Standard 1598 and certified to CAN/CSA Standard C22.2 No. 250.0.

WARRANTY

Lumenwerx provides a five-year limited warranty on electrical and mechanical performance of the luminaires, including the LED boards, drivers, and auxiliary electronics. Lumenwerx will repair or replace defective luminaires or components at our discretion, provided they have been installed and operated in accordance with our specifications. Other limitations apply, please refer to the full warranty on our website.