

UBIK SEAL PERIMETER

LUMENWERX

RECESSED PATTERN
CHROMAWERX - SOLA AND DUO



Project: _____
Type: _____

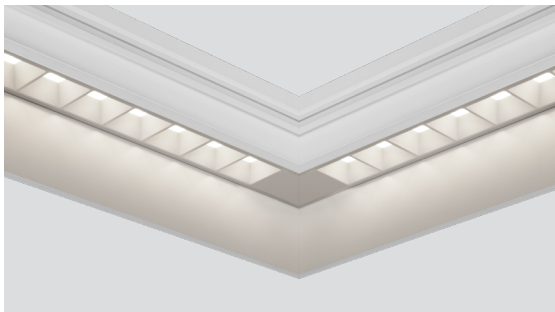

DESCRIPTION

Sleek square form meets superb function in UbiK, a lighting family designed to provide a multitude of creative options. Designed with a 2.5" aperture, UbiK Seal Perimeter offers subtle, low-glare illumination in level, shallow, and deep recessed arrangements with parabolic louver option for direct illumination. UbiK Seal Perimeter comes in Chromawerx Sola and Duo. For static white and full spectrum solutions, consult other spec sheets.



Order Guide

LUMINAIRE ID	DISTRIBUTION	OPTIC	LIGHT SOURCE ²	CRI
	D			
UBISEALPERLP ¹ - UbiK Seal Perimeter Level Pattern UBISEALPERSP ¹ - UbiK Seal Perimeter Shallow Pattern UBISEALPERDP ¹ - UbiK Seal Perimeter Deep Pattern ¹ IP54 rated gasketed construction with an additional clear polycarbonate lens.	D - Direct	MWPL - Matte White Parabolic Louver MSPL - Matte Silver Parabolic Louver MBPL - Matte Black Parabolic Louver	SOLA - Dim-to-warm single channel control 35K to 22K DUO - Tunable white 2-channel control 65K to 27K ² Static white and full spectrum also available. Consult other spec sheet.	80 - 80 CRI 90 - 90 CRI

LUMEN PACKAGE	PATTERN LENGTH	CORNER TYPE	CORNER DEGREE	VOLTAGE	DRIVER ⁵
350 - Low output 350 lm/ft 500 - Medium output 500 lm/ft 750 ³ - High output 750 lm/ft ³ Available for non-IC applications only.	#FT#IN ⁴ - Specify nominal length (#) Standard nominal lengths: Single units: 4' to 12' Continuous runs: lengths over 12' ⁴ Parabolic louvers are only available in 6" increments. If the fixture length is not a multiple of 6", blanks of equal length will be added at both ends of the fixture.	LEVO - Leveled outside corner LEVI - Leveled inside corner	90(#) - 90 degrees, specify number of corners (#) #(#) - Other degrees, specify the angle degree #, followed by the number of corners (#)	120 - 120V 277 - 277V UNV - 120V-277V	SOLA SD1 - Single 0-10V input DUO DMX ^{6,7} - DMX DDA ⁷ - DALI DT6 DDA8 ⁷ - DALI DT8 DD1 - Dual 0-10V input for CCT/intensity PSQO ⁷ - Lutron T-Series 1% Tunable White ⁵ PoE (Power-over-Ethernet) compatible. Consult factory for details. ⁶ For more information, see pages 8 to 13. ⁷ On-site commissioning is required.

ELECTRICAL	MOUNTING	FINISH	OPTIONS
1C			
1C - 1 circuit	TG9 - Tegular 9/16" TG15 - Tegular 15/16" TB9 - T-bar 9/16" TB15 - T-bar 15/16" ST - Screw slot T-bar DTR - Drywall trim DTL - Drywall trimless DMF - Drywall mud flange	W - Matte white AL - Aluminum B - Matte black WA - White antimicrobial Silverwerx CF# - Custom finish, specify RAL#	FU120 - Fuse 120V FU277 - Fuse 277V CP - Chicago Plenum G GK - Grid gasket NATA - Natatorium finish CRF - Corrosion-resistant finish NA - None

Accessories

Optional, order separately

DMX WALL CONTROLLER ⁸
WCW - Wall controller white WBW - Wall controller black ⁸ Available with DMX only. For more information, see pages 8 to 13, or consult factory.

UBIK SEAL PERIMETER

LUMENWERX

RECESSED PATTERN
CHROMAWERX - SOLA AND DUO

Pattern



HOW TO SPECIFY A PATTERN?

Please follow these steps when specifying in order to be as precise as possible.

- (1) We require a drawing illustrating the pattern you are trying to achieve - anything from a simple line drawing to elaborate architectural drawings will suffice. Please mark clearly on the drawing the location of the wall.
- (2) Under **PATTERN LENGTH**, enter the overall length of your pattern - either in feet or inches.
- (3) Under **CORNER TYPE**, please enter LEVO for leveled outside corner or LEVI for leveled inside corner.
- (4) Under **CORNER DEGREE**, please enter the angle in degrees of each corner required to complete your pattern, followed by the number of corners.

PATTERN LENGTH	CORNER TYPE	CORNER DEGREE
<p>#FT#IN¹ - Specify nominal length (#)</p> <p>Standard nominal lengths: Single units: 4' to 12' Continuous runs: lengths over 12'</p> <p>¹Parabolic louvers are only available in 6" increments. If the fixture length is not a multiple of 6", blanks of equal length will be added at both ends of the fixture.</p>	<p>LEVO - Leveled outside corner LEVI - Leveled inside corner</p>	<p>90(#) - 90 degrees, specify number of corners (#) #(°) - Other degrees, specify the angle degree #, followed by the number of corners (#)</p>

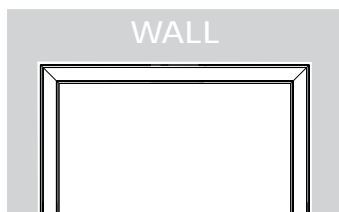

Inside Corner

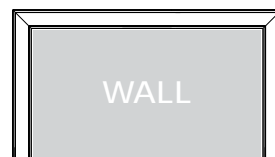

Outside Corner

UBIK SEAL PERIMETER

LUMENWERX

RECESSED PATTERN
CHROMAWERX - SOLA AND DUO

Photometrics

Watts and lumens per watt may vary based on the type of driver selected.

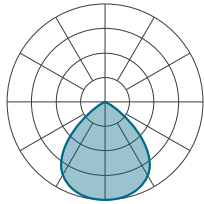

MWPL - Level - Delivered Lumens at 35K at 80 CRI

LUMENS PER FOOT	TOTAL LUMENS PER 4FT	INPUT WATTAGE	LPW
350	1400	10.4	135
500	2000	15.1	133
750	3000	23.4	128

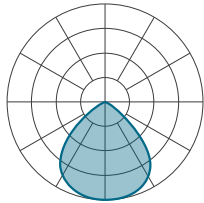

MWPL - Shallow - Delivered Lumens at 35K at 80 CRI

LUMENS PER FOOT	TOTAL LUMENS PER 4FT	INPUT WATTAGE	LPW
350	1400	10.9	129
500	2000	15.8	127
750	3000	24.6	122

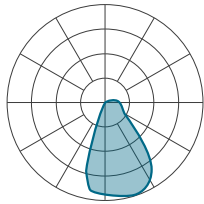

MWPL - Deep - Delivered Lumens at 35K at 80 CRI

LUMENS PER FOOT	TOTAL LUMENS PER 4FT	INPUT WATTAGE	LPW
350	1400	11.2	125
500	2000	16.2	123
750	3000	25.2	119

UBIK SEAL PERIMETER

LUMENWERX

RECESSED PATTERN
CHROMAWERX - SOLA AND DUO

Cross sections

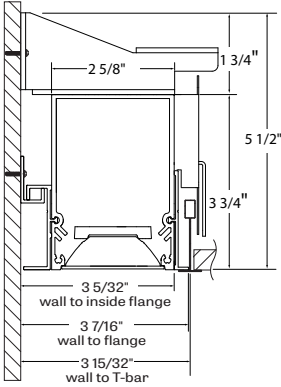

Ubik Seal Perimeter - Level

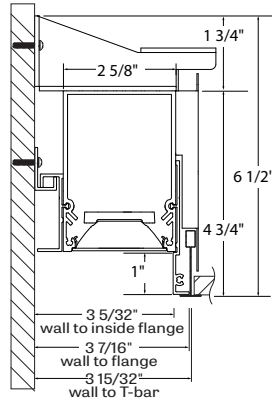

Ubik Seal Perimeter - Shallow

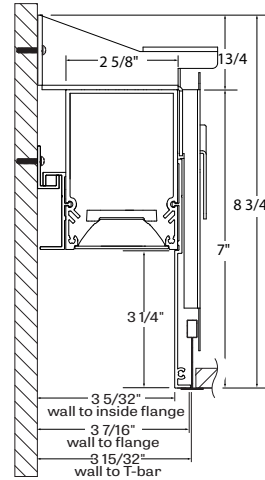

Ubik Seal Perimeter - Deep

Technical Specifications

OPTICS

Parabolic Louvers

Parabolic louvers provide excellent shielding and a pleasing crisp visual texture. The precisely molded louvers consist of 1" deep blades and is 2"x2" in size. The LED array is secured in the direct position, with the light transmitting through a beam-forming lens creating a conical distribution. Three matte (MPL) finishes are available in black, white and silver, offering a soft appearance, a wide beam spread of up 85-91 degrees, gentle brightness transition at cut-off, and exceptional UGR.



LIGHT SOURCE

Custom linear array of alternating color temperature mid-flux LEDs are mounted directly to the housing for optimal thermal performance. For the Duo products, a color temperature range from 6500K-2700K is achievable with color points on or below the black body curve. For the Sola products, a color temperature range from 3500K-2200K is controlled synchronously with intensity. Color consistency between fixtures is maintained to within 3 SDCM. LEDs are operated at reduced drive current to optimize efficacy and lumen maintenance.

All LEDs have been tested in accordance with IESNA LM-80-08 and the results have shown L80 lumen maintenance greater than 60,000 hours. Absolute product photometry is measured and presented in accordance with IESNA LM-79, unless otherwise indicated.

UBIK SEAL PERIMETER

LUMENWERX

RECESSED PATTERN
CHROMAWERX - SOLA AND DUO

CHROMAWERX - TUNABLE WHITE

Chromawerx SOLA

It is a single-channel control that dims output while warming the color temperature in a pre-determined relationship. A simple analog control sends a common signal to dual output digital drivers, which are programmed to adjust a specially populated LED array to emulate the effect of dimming a filament source. Dimming range is programmable but the default option runs from 3500K at 100% of full power to 2200K at 5% of full power. CRI is maintained above 80 throughout the dimming range.

Chromawerx DUO

It is a two-channel control. It uses an analog (0-10V) protocol for separate control of luminaire CCT and intensity or a digital (DMX, DALI and PSQ0) protocol for synchronous control of both warm and cool LED arrays to enable the user to set color temperature and light output. Commonly called “tunable white”, Chromawerx two-channel control provides the range of cool (6500K) to warm (2700K) color that can be useful for helping to entrain circadian rhythms, stimulate alertness for improved educational and work productivity, and compensate for jet lag, among other applications. The Chromawerx drivers are programmed to limit maximum light output and power usage across all color temperatures. CRI is maintained above 80.

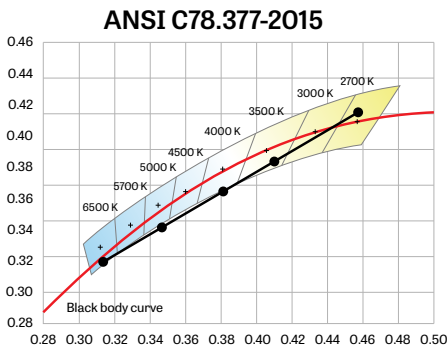

WELL for Light - The WELL building standard focuses on light quality in several features. There are three categories that are fully attributed to the construction and features of a luminaire. In WELL V1, it's Feature 54 Circadian Lighting, Feature 55 Glare Control, and Feature 58 Color Quality. In WELL V2, it's Feature L03 Circadian Lighting, Feature L04 Glare Control, and Feature L07 Electric Light Quality.

This fixture meets Features:

- Feature 54 or L03 when DUO is selected
- Feature 58 or L07 when 90 CRI is selected

All LED drivers used at Lumenwerx are deemed to have a low risk level of flicker, of 5 % or less below 90Hz operational as defined by IEEE standard 1789-2015 LED.



WELL for Mind - This luminaire meets WELL for mind as it is a human centric luminaire offering quality light, excellent color, and smooth optics. If any of these features are incorporated in a luminaire, it can improve the ability to focus, concentrate, and persist longer on a given task. This fixture harmoniously operates in a space to assist the mind.

For more information please contact well@lumenwerx.com.

PATTERN LENGTH

All individual sections are joined together onsite using the joiner kits provided. Lumenwerx offers joiner kits that are extremely simple to work with in the field and result in a fixture that appears virtually seamless with no light leak at any connection.

ELECTRICAL

SOLA

SDI

Factory-set, adjustable output current LED driver with universal (120-277VAC) input. Using a single 0-10V control signal, the light output warms in color temperature as it dims down to 1% and 2200K. At maximum driver load, efficiency < 86%, PF > 0.9, THD < 20%.

UBIK SEAL PERIMETER

LUMENWERX

RECESSED PATTERN
CHROMAWERX - SOLA AND DUO

DUO

DMX

Factory-set adjustable output current electronic driver with 120-277V AC line input. Using DMX wall controls (optionally supplied by Lumenwerx) or an existing DMX control system, both channels of LEDs are independently adjustable. Each DMX driver can be independently addressed using the built-in RDM (Remote Device Management) in the field. Dimming down to 1% is attainable. Rated life (90% survivorship) of 50,000 hours at 50°C maximum ambient temperature. At maximum driver load, efficiency <math>< 84\%</math>, PF > 0.9, THD < 20%.

DALI

Factory-set adjustable output current electronic driver with 120-277V AC line input. Using an existing DALI control system (supplied by others), one control channel adjusts the fixture color temperature, and the other control channel adjusts fixture brightness. With DALI Type 6, two DALI addresses are required to control both channels. With DALI Type 8, one DALI address is required to control both channels. Dimming down to 1% is attainable. Rated life (90% survivorship) of 50,000 hours at 50°C maximum ambient temperature. At maximum driver load, efficiency <math>< 84\%</math>, PF > 0.9, THD < 20%.

DDI

Factory-set adjustable output current LED driver with universal (120-277VAC) input. Controlled via two individual 0-10V signals, one for setting light output down to a minimum of 1% and the other for adjusting the CCT (default range of 6500K-2700K). Rated life of 50,000 hours at 70°C maximum driver case temperature and 100% load conditions. Typical efficiency of 86%, PF > 0.9, THD < 20% at 100% load conditions.

PSQ0

Lutron T-Series 2-Channel tunable white drivers enable high-performance human centric lighting (HCL) applications. Digital control of color temperature (CCT) and intensity are achieved when used with the ESN T-Series tunable white controller as a part of a Lutron Quantum System.

PoE

Depending on the PoE manufacturer selected, Lumenwerx will install the node in factory as either integral to the luminaire or as a remote module. Factory programming of the PoE node may or may not enable the following functionalities: lumen package, Duo (tunable white), emergency battery backup, and sensor integration. These must be addressed and evaluated on a case-by-case basis.

MOUNTING OPTIONS

Recessed fixtures can be mounted into exposed or concealed T-bar or tegular grid ceilings.

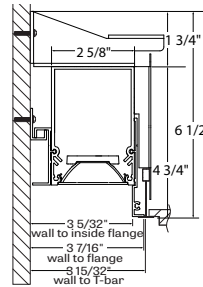

TG9 - Tegular 9/16"

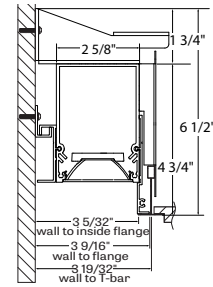

TG15 - Tegular 15/16"

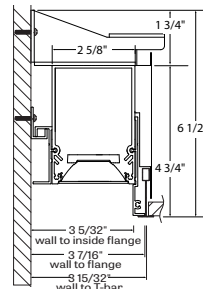

TB9 - T-bar 9/16"

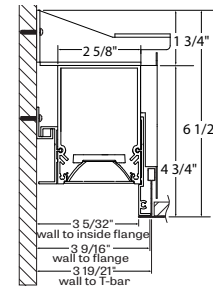

TB15 - T-bar 15/16"

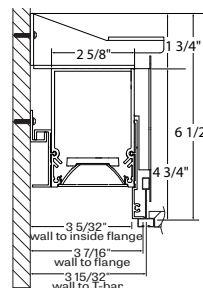

ST - Screw slot T-bar

Mounting for drywall ceilings are available with visible trim, trimless or mud flange.

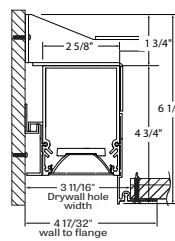

DMF - Drywall mud flange

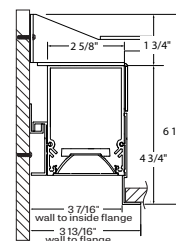

DTR - Drywall trim

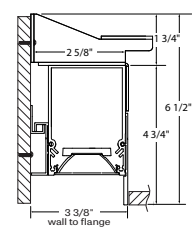

DTL - Drywall trimless

UBIK SEAL PERIMETER

LUMENWERX

RECESSED PATTERN
CHROMAWERX - SOLA AND DUO

CONSTRUCTION

Housing - Extruded aluminum (0.070" nominal) up to 90% recycled content

Joiner bracket (DTL-DTR) - Cold drawn steel 8 gauge thick

Joiner bracket (other) - Galvanised steel 16 gauge thick

Louvers - Injection molded optical grade polycarbonate up to 95% reflective

Parabolic heatsink - Extruded aluminum (0.10" nominal) up to 90% recycled content

Recessed flanges - Extruded aluminum (0.075" nominal) up to 90% recycled content

End plate - Aluminum sheet 0.19" thick

Gasket - Closed-cell silicone foam gasket.

Grid gasket (GGK option) - 1/16" closed-cell silicone foam, assures a better seal between the fixture and the grid.

FINISH

Interior - 95%, reflective matte powder coated white paint

Exterior - Powder-coat paint in standard white, aluminum, or black. Optional antimicrobial finish, as well as custom finishes, also available.

CERTIFICATIONS

ETL - Rated for Indoor Dry/Damp locations. Conforms to UL Standard 1598 and certified to CAN/CSA Standard C22.2 No. 250.0.

IC rated - Suitable for direct contact with insulation

Chicago Plenum - City of Chicago approved (CCEA)

WARRANTY

Lumenwerx provides a five-year limited warranty of electrical and mechanical performance of the luminaires, including the LED boards, drivers, and auxiliary electronics. Lumenwerx will repair or replace defective luminaires or components at our discretion, provided they have been installed and operated in accordance with our specifications. Other limitations apply, please refer to the full warranty on our website.

UBIK SEAL PERIMETER

LUMENWERX

RECESSED PATTERN
CHROMAWERX - SOLA AND DUO

DUO DMX SPECIFICATION

A qualified DMX integrator is required to assure proper installation and commissioning of the DMX network. **When placing the PO, please provide the contact information of your DMX integrator.**

Please answer the following questions to help us identify your DMX network requirements.

YES

Do you require a wall controller provided by Lumenwerx?

NO

DMX controller supplied by Lumenwerx

DMX control system supplied by others. Lumenwerx will supply DMX-enabled fixtures with default DMX addressing. See following pages for technical DMX informations. ✓

How many zones do you have?
A zone consists of one or more luminaires behaving identically.

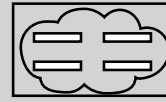

1 Zone



2 Zones

How to calculate the required number of drivers:

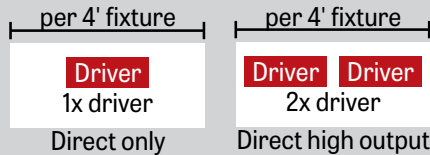

To Calculate # of drivers

1 - 4 Zones

5 or more Zones

Do you have more than 32 drivers in total?

NO

YES

Order a standard Lumenwerx wall controller.

WALL CONTROLLER

WCW - wall controller white
WCB - wall controller black

Add the control code at the end of your order code. Please provide a fixture layout or RCP (Reflected Ceiling Plan) showing the locations of the DMX fixtures, zones and the DMX wall controller. Refer to your DMX integrator for the installation. ✓

Subject to factory evaluation. Please contact our controls specialist at controls@lumenwerx.com. Additional cost and equipment will be required. ✓

Subject to factory evaluation and approval. Please contact our controls specialist at controls@lumenwerx.com. Additional cost and equipment will be required. ✓

UBIK SEAL PERIMETER

LUMENWERX

RECESSED PATTERN
CHROMAWERX - SOLA AND DUO

GENERIC DMX NETWORK ARCHITECTURE

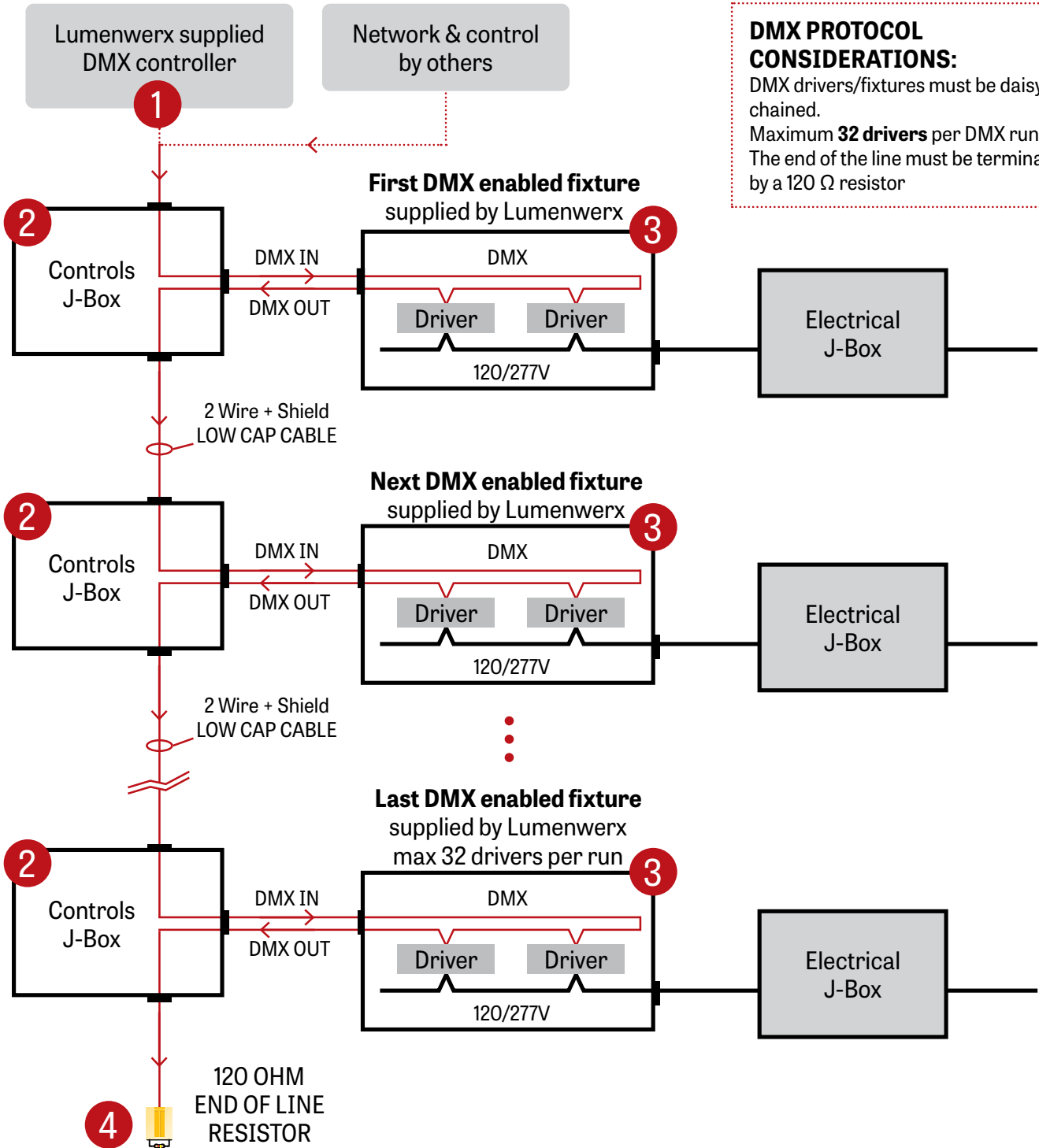

UBIK SEAL PERIMETER

LUMENWERX

RECESSED PATTERN
CHROMAWERX - SOLA AND DUO

1 LUMENWERX SUPPLIED DMX CONTROLLER

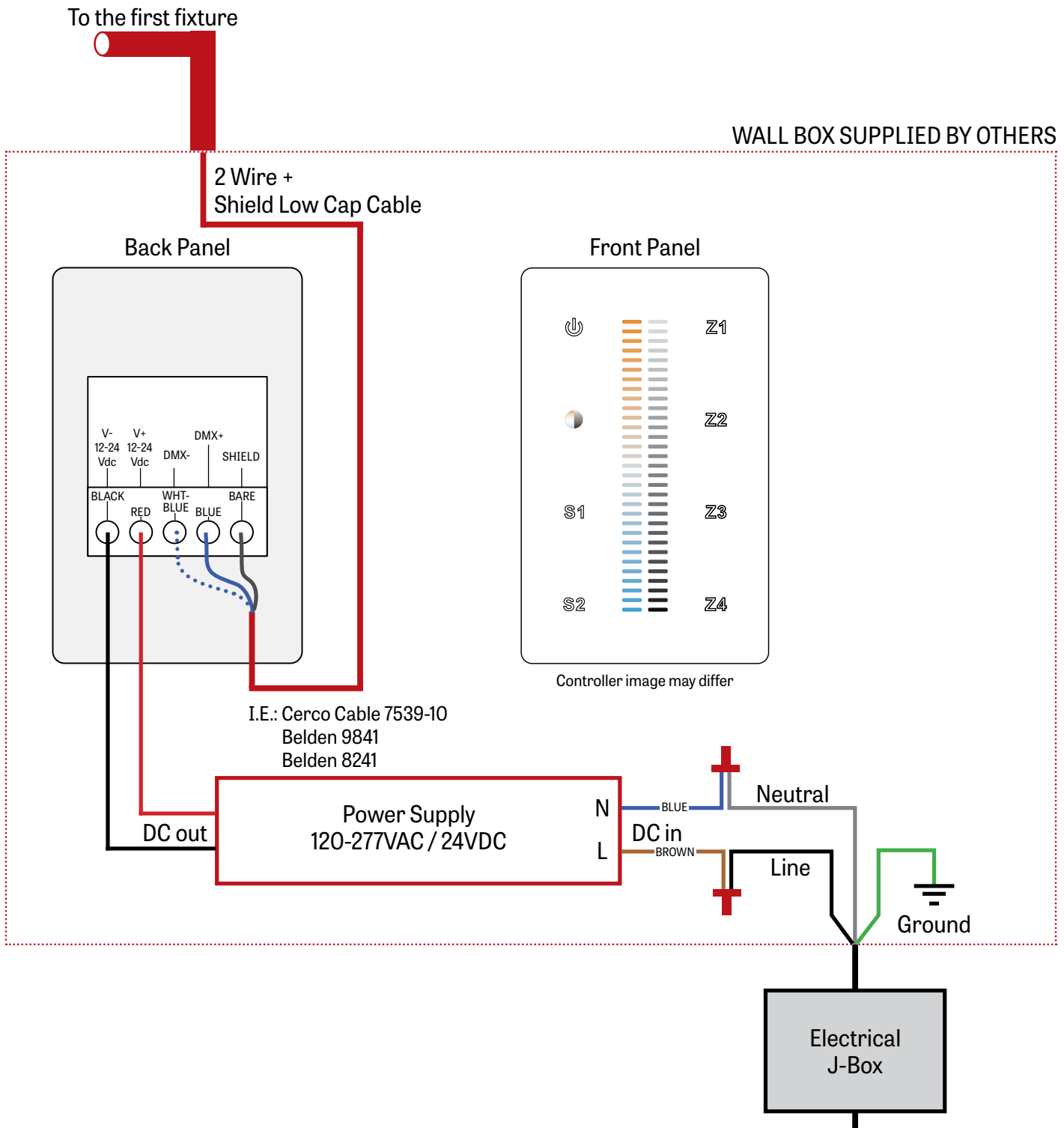

UBIK SEAL PERIMETER

LUMENWERX

RECESSED PATTERN
CHROMAWERX - SOLA AND DUO

2 J-BOX DMX DAISY CHAIN DETAIL

Low capacitance DMX Cable from Previous Fixture

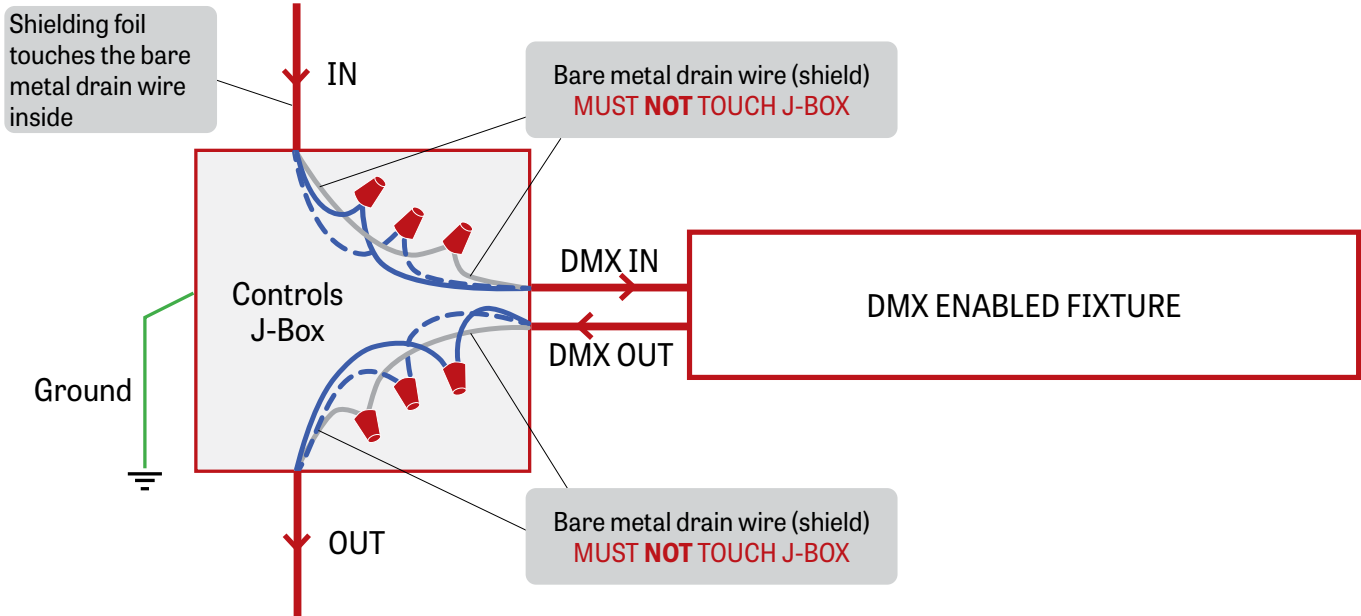

Low capacitance DMX cable to next fixture

3 DMX CONNECTION RECESSED & SURFACE

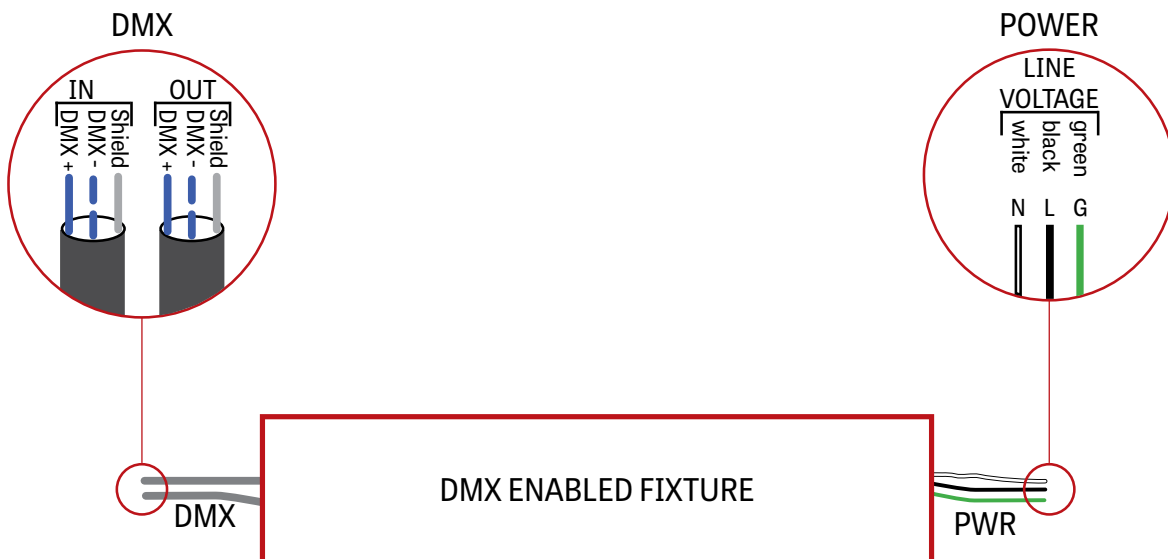

UBIK SEAL PERIMETER

LUMENWERX

RECESSED PATTERN
CHROMAWERX - SOLA AND DUO

4 DMX LAST FIXTURE DETAIL

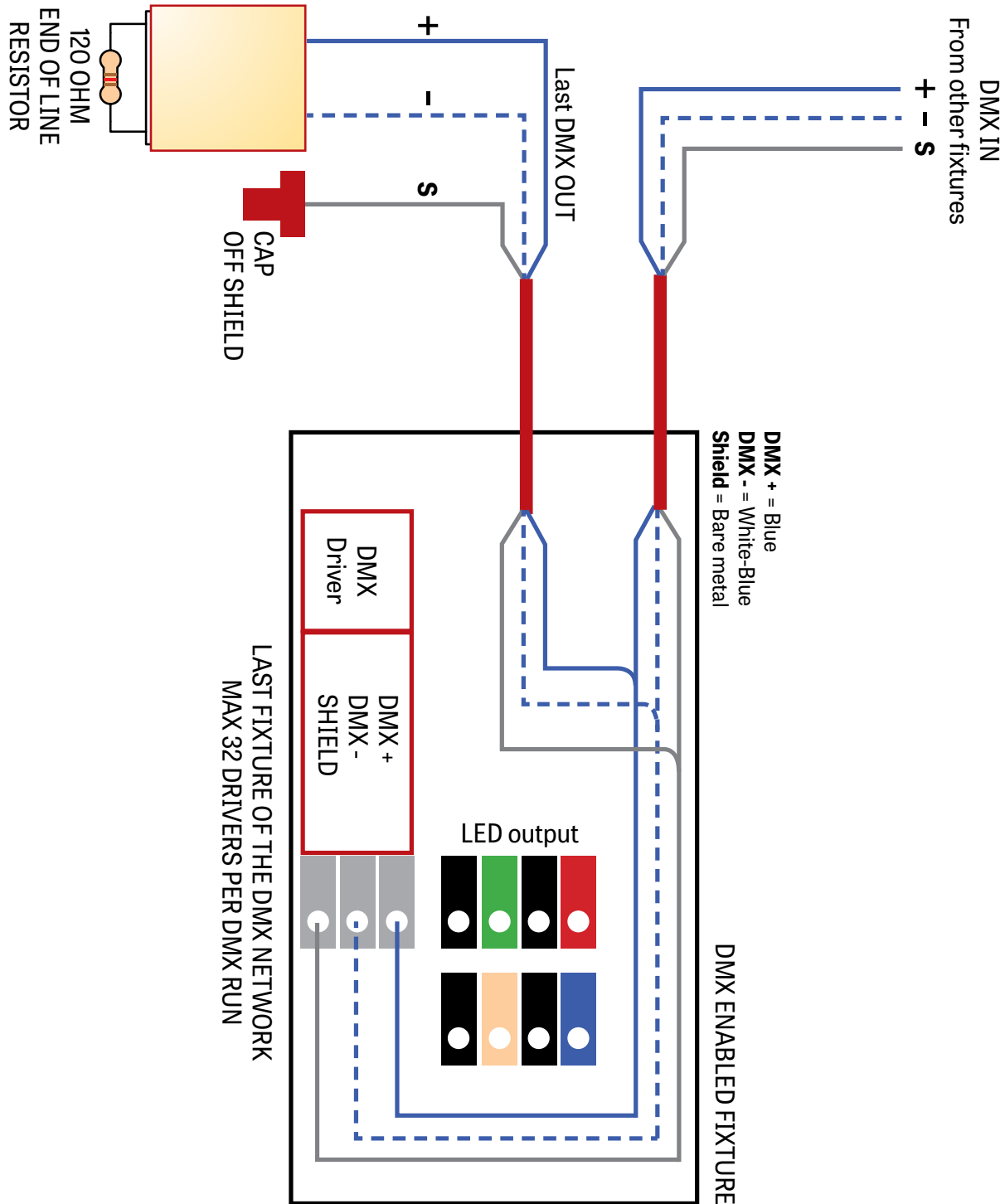

UBIK SEAL PERIMETER

LUMENWERX

RECESSED PATTERN
CHROMAWERX - SOLA AND DUO

DMX WALL CONTROLLER

DUO 1-4 ZONE

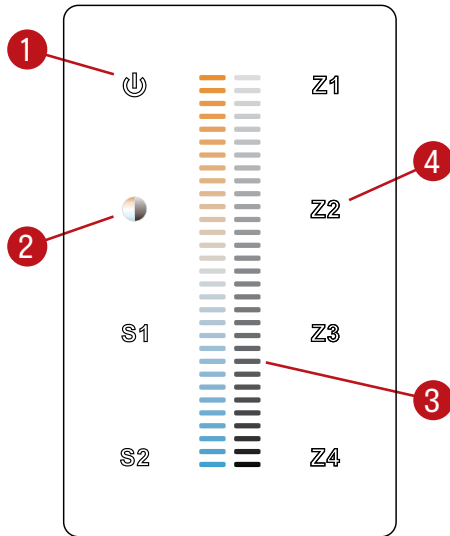

- (1) Power: Use this button to turn ON or OFF the fixture.
- (2) Brightness/CCT: Use the color/brightness toggle button to choose between color/brightness. When Blue: brightness is selected, when Yellow: color is selected.
- (3) Slider: Depending on the mode chosen in step 2, the slider will allow the user to set desired color or brightness.
- (4) Zone select: Up to 4 zones can be selected either independently or together. Once selected, the commands will be sent to the zone identified by a Blue LED.

Default DMX Addresses:

- 1 Warm
- 2 Cool