

VIA 2

ACOUSTIX - CHROMAWERX
SOLA AND DUO

LUMENWERX



Project: _____

Type: _____

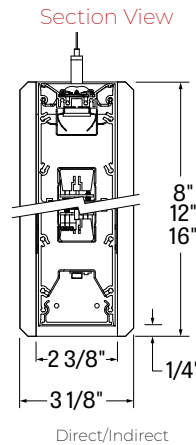

Via 2 Acoustix is an acoustic environmentally sound linear luminaire system for pendant installation available in set lengths or continuous runs. Via 2 Acoustix features numerous optical configurations, flush and drop diffusers as well as other light distributions, including wall washing and asymmetric optics, which are difficult to achieve in such a compact acoustic luminaire. Via 2 Acoustix is available in Static White and Biologically optimized lighting. Chromawerx QUADRO, DUO and SOLA are also available, see separate spec sheets.

Order Guide

LUMINAIRE ID	DISTRIBUTION	DIRECT OPTICS	DIRECT LENS POSITION	INDIRECT OPTICS	LIGHT SOURCE	CRI	DIRECT LUMEN PACKAGES	INDIRECT LUMEN PACKAGES
VIA2ACOP		HLO		WIO2				
VIA2ACOP - Via 2 Acoustix Pendant	DI - Direct/Indirect D - Direct I - Indirect	HLO - High-Efficiency Lambertian Optic	FH - Flush 1.0D - 1.0" drop	WIO2 - Widespread Indirect Optic	DUO - Tunable white 2-channel control 27K to 65K SOLA - Dim-to-warm single channel control 22K to 35K	80 - 80CRI 90 - 90CRI	350 - Min. low output 350lm/ft 500 - Medium output 500lm/ft 750 - Max. high output 750lm/ft	350 - Min. low output 350lm/ft 500 - Medium output 500lm/ft

LUMINAIRE LENGTH	LUMINAIRE HEIGHT	VOLTAGE	DRIVER	ELECTRICAL	
Standard individual sections (nominal length): 4', 6', 8' Continuous runs: lengths over 8'; built with 4', 6', 8' sections #FT ¹ - Specify nominal length (#) in 2 foot increments ¹ Consult factory for other lengths.	8 - 8 inches 12 - 12 inches 16 - 16 inches	120 -120V 277 - 277V UNV - 120V-277V	SOLA SD1 - Single 0-10V input	DUO DMX ^{2,3} - DMX DA ² - DALI DD1 - Dual 0-10V input for CCT/intensity PSQ0 ² - Lutron T-Series 1% Tunable White ² On-site commissioning is required. ³ To specify, see pages 7 to 12.	1 - 1 circuit 2 ⁴ - 2 circuits +EM ^{4,5} - Emergency light circuit +NL - Night light circuit ^{4,5} +EM/NL only available for 8' or longer. ⁵ Available with 0-10V drivers only.

MOUNTING	FIXTURE FINISH	FELT COLOR	OPTIONS	DMX WALL CONTROLS (OPTIONAL) ⁹
53WAC36W ⁶ - 36" aircraft cable, white canopies (5" power + 3" non-power), white power cord 53WAC36B ⁶ - 36" aircraft cable, white canopies (5" power + 3" non-power), black power cord 55WSW18 - 18" white stem, white canopies (5" power + 5" non power) ⁶ Power cord is 6" longer than suspension length. Consult factory for other lengths. For all other options, refer to our Pendant Mounting Guide	W - Matte white	STANDARD COLORS FWN LVN FON LEN ION CYN TBN PMN MDN FGN	PREMIUM COLORS ^{7,8} PKN CDN IVN BHN OGN LCN SLN CFN LNN SYN CNN GRN LMN BLN GHN MON EGN NVN CLN ESN ⁷ Please consult factory for more color options. ⁸ Lead time may vary.	FU - Fuse TB# - T-bar caddy clip, specify grid size TG# - Tegular caddy clip, specify grid size ST - Screw slots caddy clip CU - Custom WCW - Wall controller white WCB - Wall controller black ⁹ For more information, see pages 7 to 12, or consult factory.

VIA 2

ACOUSTIX - CHROMAWERX
SOLA AND DUO

LUMENWERX



Project: _____

Type: _____

Standard Color Options

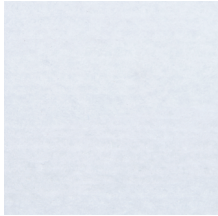

FWN - FROST WHITE

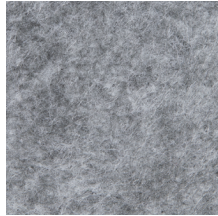

FON - FOG

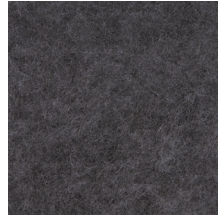

ION - IRON

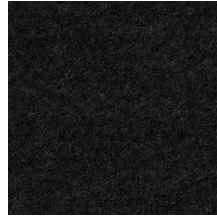

TBN - TRUE BLACK



MDN - MIDNIGHT BLUE



LVN - LAVENDER



LEN - LATTE



CYN - CHERRY



PMN - PLUM



FGN - FOREST GREEN

Premium Color Options*



PKN - PAPRIKA



OGN - ORANGE



LNN - LEMON



LMN - LIME



EGN - EVERGREEN



CDN - CLOUDY



LCN - LICHEN

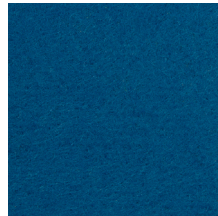

SYN - SKY



BLN - BLUEBERRY



NVN - NAVY



IVN - IVORY



SLN - STEEL



CNN - CARBON

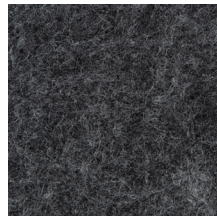

GHN - GRAPHITE

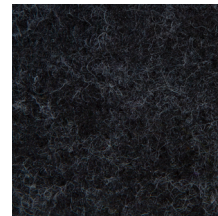

CLN - CHARCOAL



BHN - BLUSH



CFN - CAFÉ



GRN - GREIGE



MON - MOCHA



ESN - ESPRESSO

*Please consult factory for more color options.
*Lead time may vary.

VIA 2

ACOUSTIX - CHROMAWERX
SOLA AND DUO

LUMENWERX



Project: _____

Type: _____

DIMENSIONS

Front view

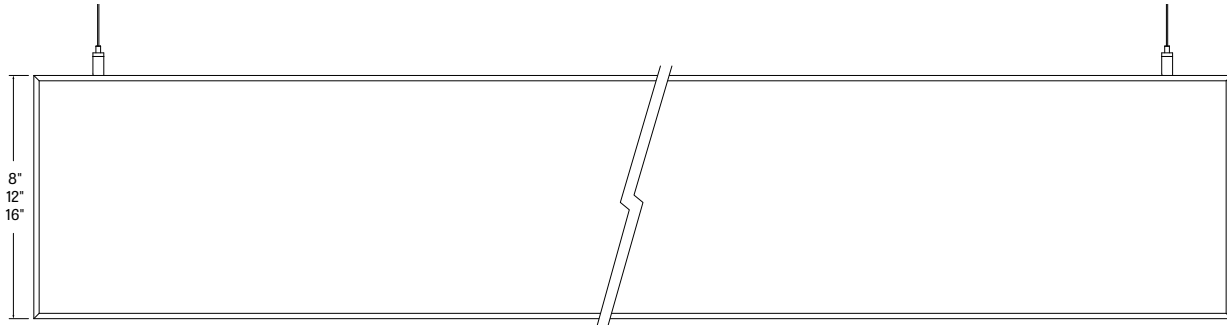

Side view

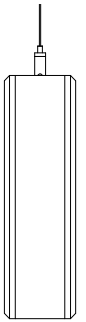

Bottom view

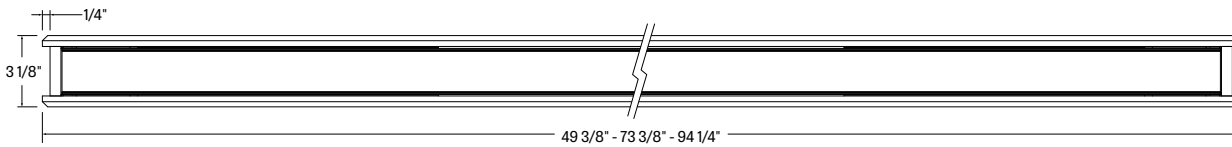



Project: _____

Type: _____

ACOUSTIC CALCULATOR

Using the Lumenwerx Acoustix Value Calculator table, you can determine the number of acoustic luminaires required in a space by fixture type. We have three levels of recommended sound reduction: good, better, and best. Choosing one of these options will reduce the sound accordingly. The best option indicates the best acoustic improvement. Calculations are based on a standard ceiling height of 9 feet.



- 1 Calculate the square feet of your room (L x W).
- 2 Choose the level of acoustical improvement you are looking for, and find the corresponding value based on your room dimension and luminaire configuration.

% in reduction in reverberation time		
😊	GOOD	25%
😊😊	BETTER	40%
😊😊😊	BEST	50%

LENGTH	HEIGHT	Room dimensions under 300 sq ft			Room dimensions over 300 sq ft		
		GOOD 😊	BETTER 😊😊	BEST 😊😊😊	GOOD 😊	BETTER 😊😊	BEST 😊😊😊
4 Feet	8"	19	9	6	29	15	10
	12"	29	14	8	45	22	14
	16"	38	19	12	58	29	19
6 Feet	8"	28.5	13.5	9	43.5	22.5	15
	12"	43.5	21	12	67.5	33	21
	16"	57	28.5	18	87	43.5	28.5
8 Feet	8"	38	18	12	58	30	20
	12"	58	28	16	90	44	28
	16"	76	38	24	116	58	38

- 3 Use the Lumenwerx Acoustix Value Formula to determine the number of luminaires needed in the room.

$$\text{Square feet} \div \text{Value} = \text{Number of luminaires}$$

Example:

Luminaires: Via 2 Acoustix, 4 ft long, 16" high
Room square feet: L: 20 ft x W: 18 ft = 360 sq ft
Desired acoustical improvement: Better = 29
Number of luminaires needed in the room: 360 ÷ 29 = **13 luminaires**

NOTES:

- You can mix lit and blank fixtures.
- Lumenwerx acoustic calculators were developed to act as a guide. For precise acoustic performance in a space, please consult an acoustician.

VIA 2

ACOUSTIX - CHROMAWERX
SOLA AND DUO

LUMENWERX



Project: _____

Type: _____

Technical Specifications

LUMINAIRE LENGTH

Via 2 Acoustix is made up of standard 4, 6, and 8 foot sections that may be joined together to create longer continuous run lengths. Exact run length must be noted in the product code. The minimum individual section available is 4 feet, and continuous run lengths can be ordered in 4, 6, or 8 foot sections. All individual sections are joined together onsite using the joiner kits provided. Lumenwerx joiner kits are extremely simple to work with in the field and result in a fixture that appears virtually seamless with no light leak at any connection.

CHROMAWERX - TUNABLE WHITE

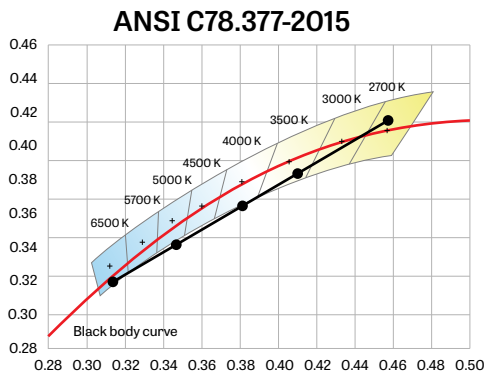

Chromawerx SOLA

It is a single-channel control that dims output while warming the color temperature in a pre-determined relationship. A simple analog control sends a common signal to dual output digital drivers, which are programmed to adjust a specially populated LED array to emulate the effect of dimming a filament source. Dimming range is programmable but the default option runs from 3500K at 100% of full power to 2200K at 5% of full power. CRI is maintained above 80 throughout the dimming range.

Chromawerx DUO

It is a two-channel control. It uses an analog (0-10V) protocol for separate control of luminaire CCT and intensity or a digital (DMX, DALI and PSQO) protocol for synchronous control of both warm and cool LED arrays to enable the user to set color temperature and light output. Commonly called "tunable white", Chromawerx two-channel control provides the range of warm (2700K) to cool (6500K) color that can be useful for helping to entrain circadian rhythms, stimulate alertness for improved educational and work productivity, and compensate for jet lag, among other applications. The Chromawerx drivers are programmed to limit maximum light output and power usage across all color temperatures. CRI is maintained above 80.

ELECTRICAL

DMX (DUO only)

Factory-set adjustable output current electronic driver with 120-277V AC line input. Using DMX wall controls (optionally supplied by Lumenwerx) or an existing DMX control system, both channels of LEDs are independently adjustable. Each DMX driver can be independently addressed using the built-in RDM (Remote Device Management) in the field. Dimming down to 1% is attainable. Rated life (90% survivorship) of 50,000 hours at 50°C maximum ambient temperature. At maximum driver load, efficiency<84%, PF>0.9, THD<20%.

DALI (DUO only)

Factory-set adjustable output current electronic driver with 120-277V AC line input. Using an existing DALI control system (supplied by others), one control channel adjusts the fixture color temperature, and the other control channel adjusts fixture brightness. Dimming down to 1% is attainable. Rated life (90% survivorship) of 50,000 hours at 50°C maximum ambient temperature. At maximum driver load, efficiency<84%, PF>0.9, THD<20%.

SDI (SOLA)

Factory-set, adjustable output current LED driver with universal (120-277VAC) input. Using a single 0-10V control signal, the light output warms in color temperature as it dims down to 1% and 2200K. At maximum driver load, efficiency<86%, PF>0.9, THD<20%.

DDI (DUO)

Factory-set adjustable output current LED driver with universal (120-277VAC) input. Controlled via two individual 0-10V signals, one for setting light output down to a minimum of 1% and the other for adjusting the CCT (default range of 2700K-6500K). Rated life of 50,000 hours at 70°C maximum driver case temperature and 100% load conditions. Typical efficiency of 86%, PF>0.9, THD<20% at 100% load conditions.

PSQO (DUO only)

Lutron T-Series 2-Channel tunable white drivers enable high-performance human centric lighting (HCL) applications. Digital control of color temperature (CCT) and intensity are achieved when used with the ESN T-Series tunable white controller as a part of a Lutron Quantum System.

VIA 2

ACOUSTIX - CHROMAWERX
SOLA AND DUO

LUMENWERX



Project: _____

Type: _____

Technical Specifications

OPTICS

High-efficiency Lambertian Optic (HLO) - shielding of diffusing 0.075" thick acrylic provides up to 88% transmission and good source obscuration. Matte white reflectors distribute LED output across the shielding. Luminaire brightness is controlled by the ratio of luminous flux to shielding area. HLO is available as a flush diffuser or as a drop diffuser, extending 1.5" below the luminaire housing. Drop diffuser is extruded with glued end caps.

Widespread Indirect Optics (WIO2) - Vertically oriented LED arrays couple light into a linear light guide. A specially designed TIR/microstructure extracts light into the desired "batwing" distribution with smooth ceiling brightness and wide spacing.

LIGHT SOURCE - LED

Custom linear array of alternating color temperature mid-flux LEDs are mounted directly to the housing for optimal thermal performance. For the DUO products, a color temperature range from 2700K-6500K is achievable with color points on or below the black body curve. For the SOLA products, a color temperature range from 2200K-3500K is controlled synchronously with intensity. Color consistency between fixtures is maintained to within 3 SDCM. LEDs are operated at reduced drive current to optimize efficacy and lumen maintenance. All LEDs have been tested in accordance with IESNA LM-80-08 and the results have shown L80 lumen maintenance greater than 60,000 hours. Absolute product photometry is measured and presented in accordance with IESNA LM-79, unless otherwise indicated.

MOUNTING OPTIONS

For cable-mounted fixtures - 53WAC36 (5" white canopy for all power mounting point, 3" white canopy for non power mounting point, and a 36" cable)

For stem mounted fixtures - 55WSW18 (5" white canopy for all power mounting point, and non power mounting point, and a 18" white stem)

Caddy clips, if required specify under OPTIONS

WEIGHT

Direct, and Indirect -

Via 2 Acoustix 4ft - 13.23lbs - 6kg

Via 2 Acoustix 8ft - 26.46lbs - 12kg

Direct/Indirect -

Via 2 Acoustix 4ft - 14.88lbs - 6.74kg

Via 2 Acoustix 8ft - 29.76lbs - 13.50kg

CONSTRUCTION

Housing - Extruded aluminum (0.095" nominal) up to 90% recycled content

Interior brackets - Die formed cold rolled sheet steel 18 gauge thick

Joining system - Die cast zinc (0.95" nominal)

Reflectors - Cold rolled steel 0.024" thick precisely die formed, 95% reflective matte white painted

Diffuser - 0.075" thick acrylic, 88% transmission

Drop diffuser - Extruded with glued end caps

End caps - Die cast aluminum (0.95" nominal)

Hanger - Chromed Griplock securely attached with spring steel hardware in end caps and/or joiners

Aircraft cable suspension - 7x7 braids aluminum aircraft cable 0.06" thick

Stem - 0.5" diameter threaded steel tube matte white or aluminum powder coating. Custom finishes are also available.

FINISH

Interior - 95%, reflective matte powder coated white paint

Exterior - matte white powder coating

ACOUSTIC FINISH

Material is 100% polyester containing up to 50% of recycled plastic bottles (PET) with an ASTM E-84 Class A fire rating and is moisture resistant.

CARE

Remove dust and debris with a clean, dry, soft, lint-free cloth, or vacuum.

ENVIRONMENT

Ambient temperature at fixture location shall not exceed 30°C/86°F. For indoor use only.

CERTIFICATIONS

ETL - Rated for Indoor Dry/Damp locations. Conforms to UL Standard 1598 and certified to CAN/CSA Standard C22.2 No. 250.0.

WARRANTY

Lumenwerx provides a five-year limited warranty of electrical and mechanical performance of the luminaires, including the LED boards, drivers, and auxiliary electronics. Lumenwerx will repair or replace defective luminaires or components at our discretion, provided they have been installed and operated in accordance with our specifications. Other limitations apply, please refer to the full warranty on our website. Wall controllers are covered by the manufacturer warranty.

VIA 2

ACOUSTIX - CHROMAWERX
SOLA AND DUO

LUMENWERX



Project: _____

Type: _____



WELL for Light - The WELL building standard focuses on light quality in several features. There are three categories that are fully attributed to the construction and features of a luminaire. In WELL V1, it's Feature 54 Circadian Lighting, Feature 55 Glare Control, and Feature 58 Color Quality. In WELL V2, it's Feature L03 Circadian Lighting, Feature L04 Glare Control, and Feature L07 Electric Light Quality.

This fixture meets Features:

- Feature 54 or L03 when DUO is selected
- Feature 55 or L04 meets WELL glare category (a-c-d)
- Feature 58 or L07 when 90CRI is selected

All LED drivers used at Lumenwerx are deemed to have a low risk level of flicker, of 5 % or less below 90Hz operational as defined by IEEE standard 1789-2015 LED.



WELL for Sound - This luminaire is recommended for use as an acoustical absorption surface to limit reverberation times (RT) in a given space. This luminaire contributes to noise reduction and vibration dampening to promote focus and concentration. Reverberation needs to be calculated in each space based on the materials used.



WELL for Mind -This luminaire meets WELL for mind as it is a human centric luminaire offering quality light, excellent color, smooth optics, and a sound diminishing element. If any of these features are incorporated in a luminaire, it can improve the ability to focus, concentrate, and persist longer on a given task. This fixture harmoniously operates in a space to assist the mind.

For more information please contact well@lumenwerx.com.



Project: _____

Type: _____

DUO DMX SPECIFICATION

A qualified DMX integrator is required to assure proper installation and commissioning of the DMX network. **When placing the PO, please provide the contact information of your DMX integrator.**

Please answer the following questions to help us identify your DMX network requirements.

YES

Do you require a wall controller provided by Lumenwerx?

NO

DMX control system supplied by others. Lumenwerx will supply DMX-enabled fixtures with default DMX addressing. See following pages for technical DMX informations. ✓

DMX controller supplied by Lumenwerx

How many zones do you have?
A zone consists of one or more luminaires behaving identically.

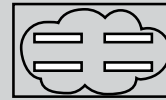

1 Zone



2 Zones

How to calculate the required number of drivers:

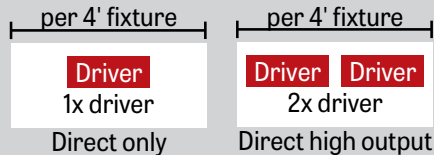

To Calculate # of drivers

1 - 4 Zones

5 or more Zones

Do you have more than 32 drivers in total?

NO

YES

Order a standard Lumenwerx wall controller.

WALL CONTROLLER

WCW - wall controller white
WCB - wall controller black

Add the control code at the end of your order code. Please provide a fixture layout or RCP (Reflected Ceiling Plan) showing the locations of the DMX fixtures, zones and the DMX wall controller. Refer to your DMX integrator for the installation. ✓

Subject to factory evaluation. Please contact our controls specialist at controls@lumenwerx.com. Additional cost and equipment will be required. ✓

Subject to factory evaluation and approval. Please contact our controls specialist at controls@lumenwerx.com. Additional cost and equipment will be required. ✓

VIA 2

ACOUSTIX - CHROMAWERX
SOLA AND DUO

LUMENWERX



Project: _____

Type: _____

GENERIC DMX NETWORK ARCHITECTURE

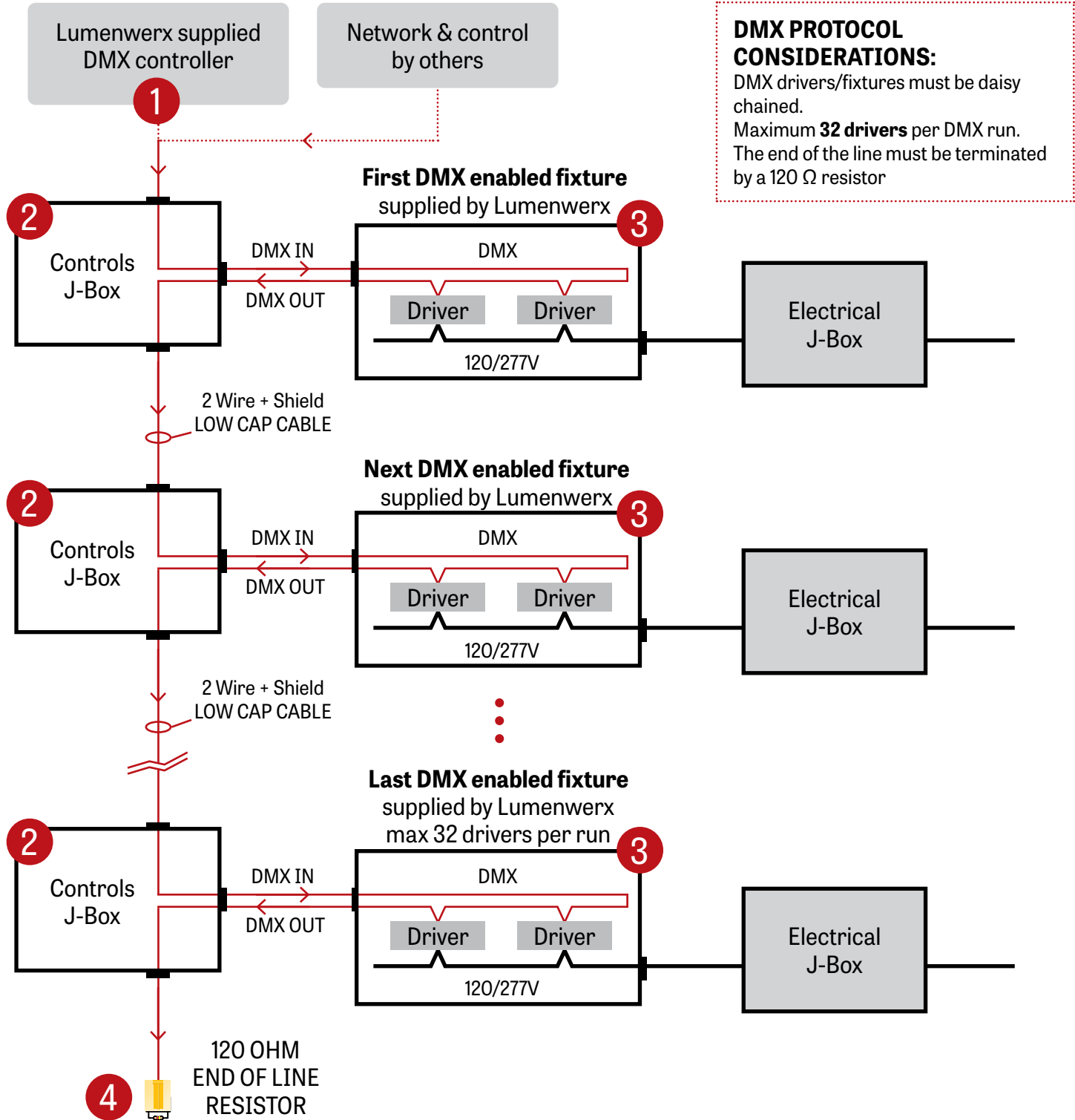



Project: _____

Type: _____

1 LUMENWERX SUPPLIED DMX CONTROLLER

To the first fixture

WALL BOX SUPPLIED BY OTHERS

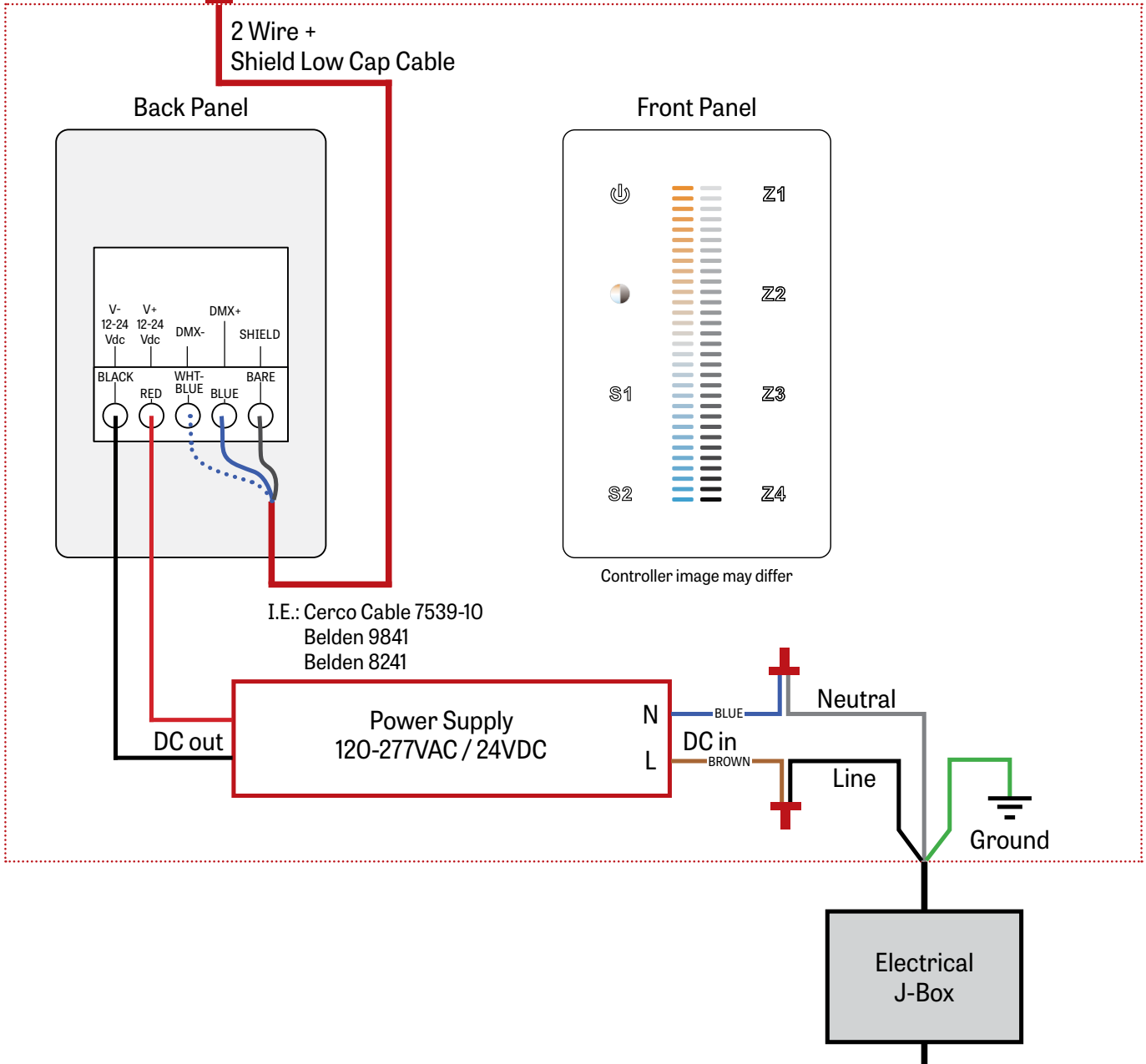



Project: _____

Type: _____

2 J-BOX DMX DAISY CHAIN DETAIL

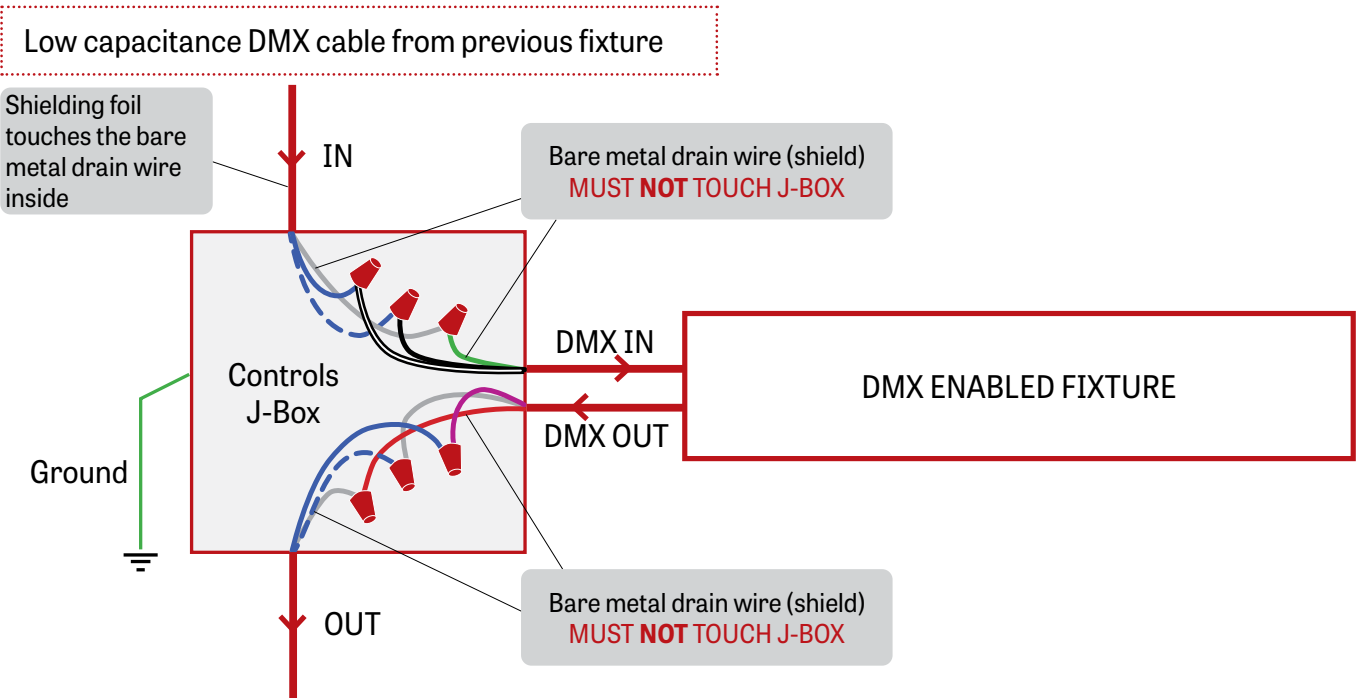

Low capacitance DMX cable to next fixture

3 DMX CONNECTION PENDANT & WALL

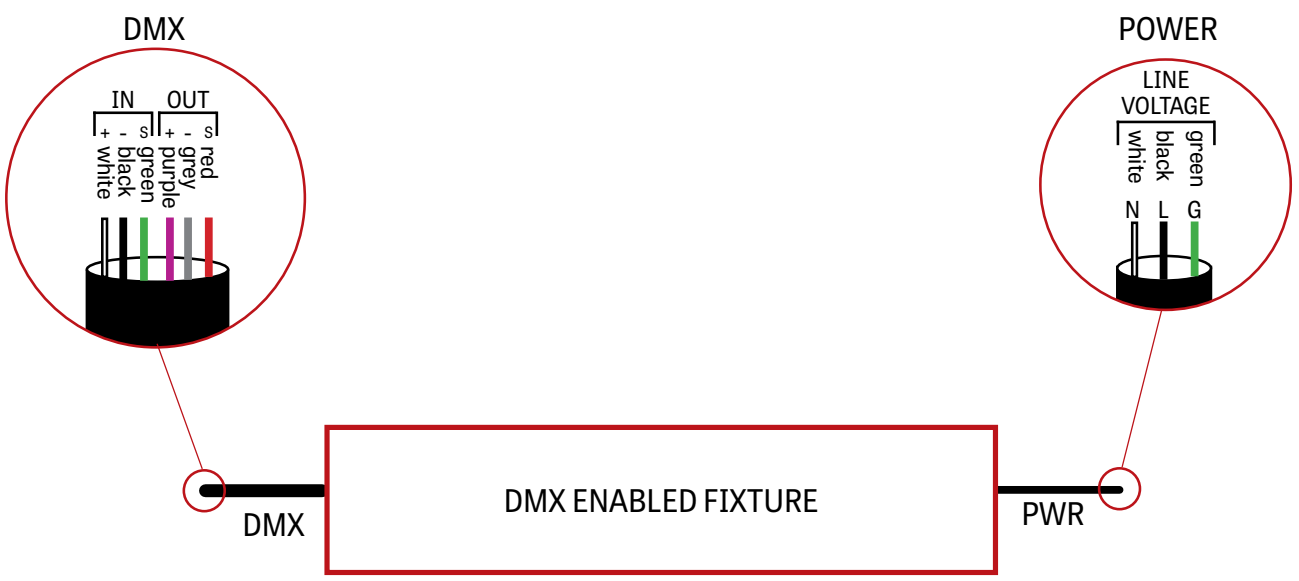

VIA 2

ACOUSTIX - CHROMAWERX
SOLA AND DUO

LUMENWERX



Project: _____

Type: _____

4 DMX LAST FIXTURE DETAIL

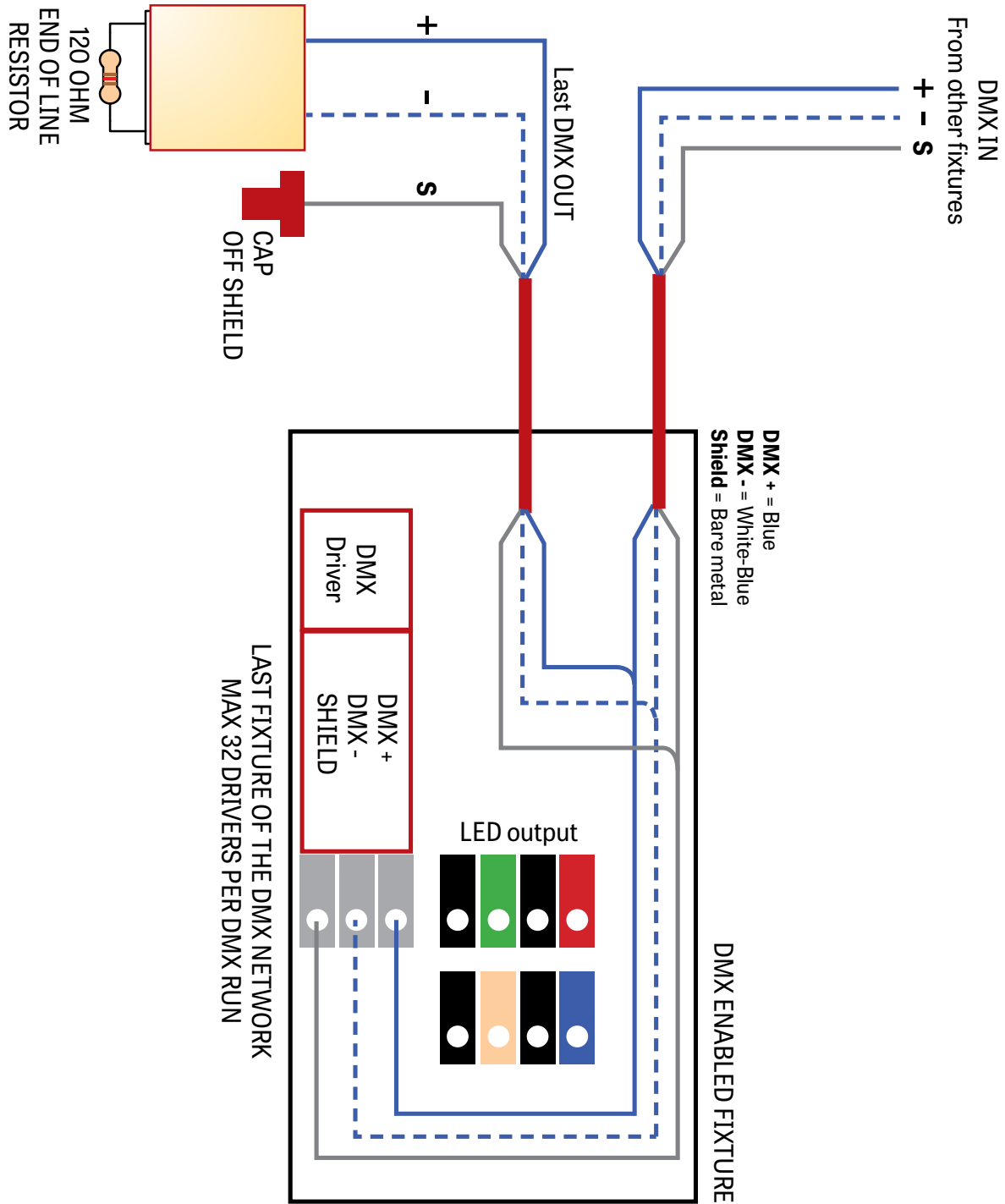

VIA 2

ACOUSTIX - CHROMAWERX
SOLA AND DUO

LUMENWERX



Project: _____

Type: _____

DMX WALL CONTROLLER

DUO 1-4 ZONE

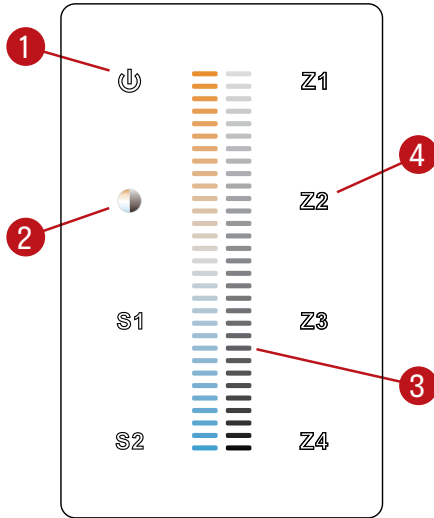

- (1) Power: Use this button to turn ON or OFF the fixture.
- (2) Brightness/CCT: Use the color/brightness toggle button to choose between color/brightness. When Blue: brightness is selected, when Yellow: color is selected.
- (3) Slider: Depending on the mode chosen in step 2, the slider will allow the user to set desired color or brightness.
- (4) Zone select: Up to 4 zones can be selected either independently or together. Once selected, the commands will be sent to the zone identified by a Blue LED.

Default DMX Addresses:

- 1 Warm
- 2 Cool