

VIA 2 RECESSED PATTERN

DIRECT

CHROMAWERX - QUADRO - RGBW



IC RATED

Declare.

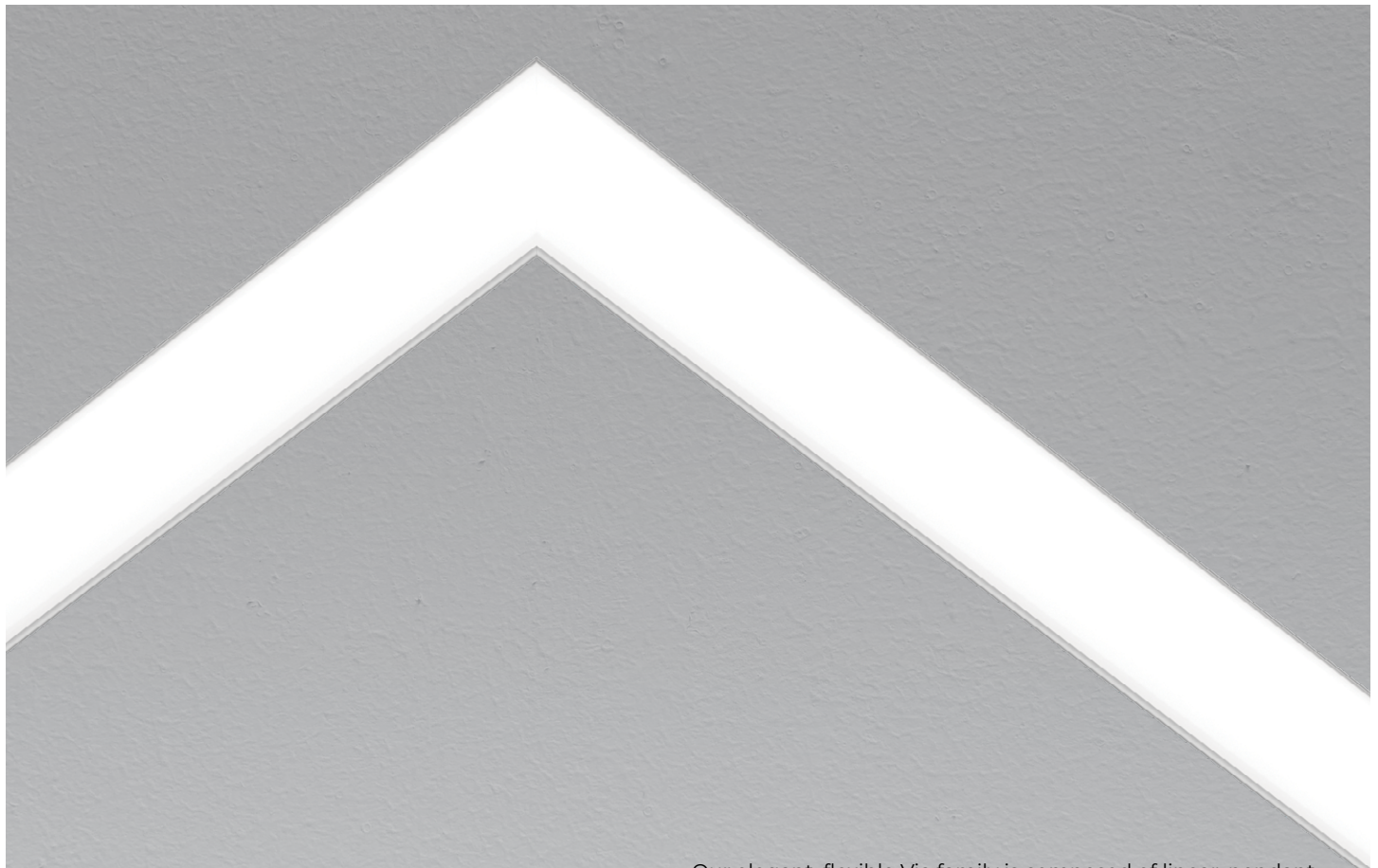

Our elegant, flexible Via family is composed of linear, pendant, surface, recessed, and wall mounted luminaires. Each lighting fixture can be installed as a discrete luminaire or in continuous runs or patterns in which a combination of luminaires forms part of a custom design that can also incorporate less conventional acute and obtuse angles. Via 2 Recessed is offered with Lambertian, asymmetric, or wall wash optics.

Lens Positions

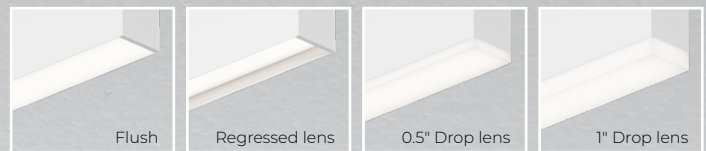

DIRECT



VIA 2 RECESSED PATTERN



DIRECT
CHROMAWERX - QUADRO - RGBW

Project: _____

Type: _____

Order Guide

A drawing of your pattern is required - anything from a line drawing to an architectural drawing.

LUMINAIRE ID	DISTRIBUTION	OPTIC	LENS POSITION	LIGHT SOURCE ²	WHITE CRI Specify NA for solid colors
VIA2RPAT	D				
VIA2RPAT - Via 2" Recessed Pattern	D - Direct	HLO - High-Efficiency Lambertian Optic ARO2 - Asymmetric Refractive Optic WRO2 - Wall Wash Refractive Optic	FH ¹ - Flush RG ¹ - Regressed 0.5D ¹ - 0.5" drop 1.0D ¹ - 1.0" drop ¹ For HLO, specify FH, RG, 0.5D, or 1.0D. [•] For ARO2 and WRO2, specify FH.	QUADRO - RGBW 4-channel control RS - Red solid GS - Green solid BS - Blue solid ² Static white, BIOS, Chromawerx SOLA, and DUO also available. Consult other spec sheets.	80CRI - 80+ CRI 90CRI - 90+ CRI NA - Not applicable

WHITE COLOR TEMP. Specify NA for solid colors	OUTPUT WATTAGE ³	PATTERN LENGTH	CORNER TYPE ⁶
27K - 2700K 30K - 3000K 35K - 3500K 40K - 4000K 50K - 5000K NA - Not applicable	5WF - 5 W/ft output 7WF ⁴ - 7 W/ft output ³ See page 3 for dedicated white channel lumen outputs. ⁴ Not available with solid colors.	##FT##IN(##X##FT##IN-##X##FT##IN-...) ⁵ - ##FT##IN: total nominal length of pattern in feet and/or inches #X: quantity of each section ##FT##IN: nominal length of each section in feet and/or inches Continuous runs: lengths over 12' ⁵ Minimum length is 4'.	#LEV2C(A##) - 2-way leveled corner #LEV3C(A##) ^{7,8} - 3-way leveled corner #LEV4C(A##) ^{7,8} - 4-way leveled corner #INN2C(A90) ^{8,9} - 2-way inner corner #OUT2C(A90) ^{8,9} - 2-way outer corner ⁶ Specify quantity (#) and angle (A##) for each required corner type. If more than one option is specified, separate codes with a "+", e.g. 1LEV2C(A90)+2LEV2C(A60). ⁷ Separate angles with a "+" if more than one type is required, e.g. 1LEV4C(A60+A120). ⁸ Not available with ARO2/WRO2. ⁹ Available with 90° only. Consult factory for other angles. ¹⁰ Minimum angle is 30°. For ARO2/WRO2, minimum angle is 75°.

VOLTAGE	DRIVER ¹¹	ELECTRICAL	MOUNTING CEILING ¹⁴	MOUNTING WALL ¹⁶	FINISH	OPTIONS ¹⁷
120V - 120V 277V - 277V UNV - 120V-277V	QUADRO DMX ^{12,13} - DMX <u>Solid colors</u> D1 - 1% 0-10V DA ¹³ - DALI ¹¹ PoE (Power-over-Ethernet) compatible. Consult factory for details. ¹² For more information, see pages 8 to 13. ¹³ On-site commissioning is required.	1C - 1 circuit	TG9 - Tegular 9/16" TG15 - Tegular 15/16" TB9 - T-bar 9/16" TB15 - T-bar 15/16" ST - Screw slot T-bar DTR - Trim DTL - Trimless DMF - Drywall mud flange NA - Not applicable MFM ¹⁵ - Multiple flange mounting ¹⁴ Transition mounting options also available (e.g. Recessed to Pendant/Surface), consult factory for details. ¹⁵ See page 4 for details.	DTR - Trim DTL - Trimless DMF - Drywall mud flange NA - Not applicable ¹⁶ Not available with leveled corners.	W - Matte white B - Matte black CF# - Custom finish, specify RAL#	FU120 - Fuse 120V FU277 - Fuse 277V FWC - Flexible whip cable (6' std) CP - Chicago Plenum NA - None ¹⁷ Separate codes with a "+" if more than one is specified.

Accessories

Optional, order separately

DMX WALL CONTROLLER ^{18, 19}

WC1W##FT - Single zone wall controller white
WC1B##FT - Single zone wall controller black
WC2W##FT - 3 zone wall controller white
WC2B##FT - 3 zone wall controller black

¹⁸ Specify wire length (##) in feet.

¹⁹ Available with DMX only. For more information, see pages 8 to 13, or consult factory.

VIA 2 RECESSED PATTERN



DIRECT

CHROMAWERX - QUADRO - RGBW

Dimensions

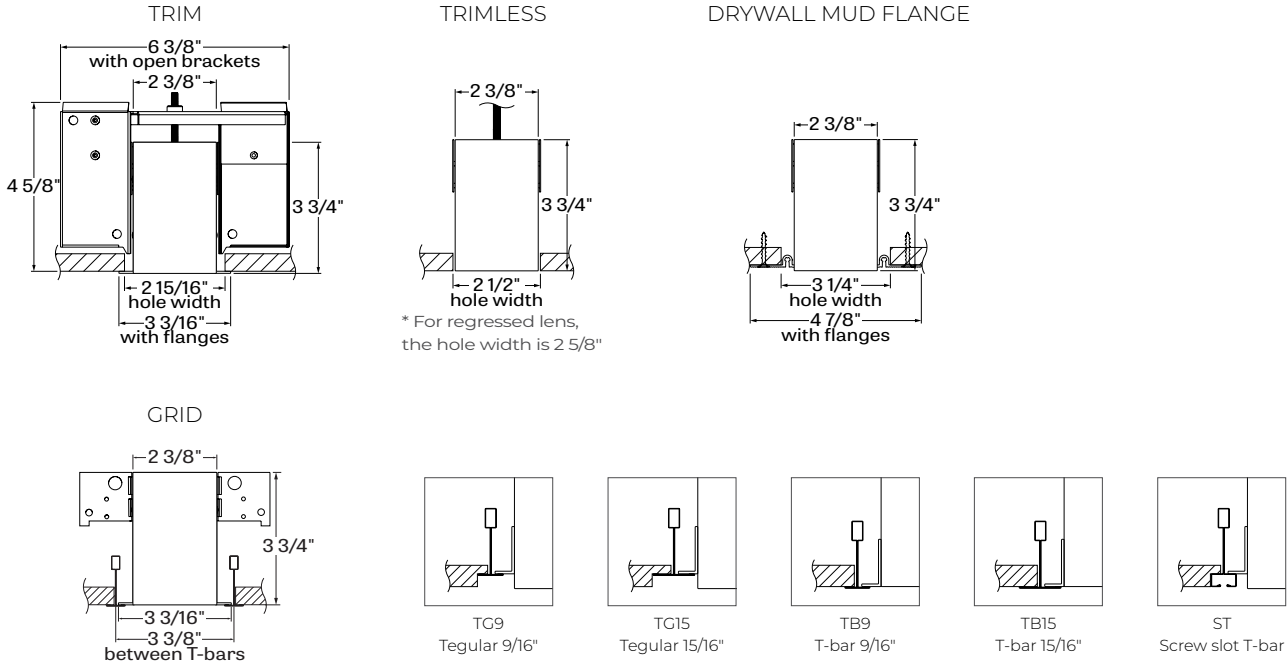

LENS POSITIONS

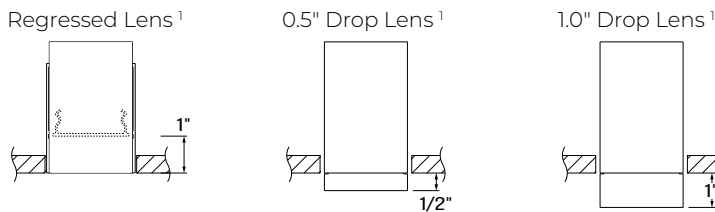

¹ Only available with HLO.

Photometrics

Dedicated white channel lumen outputs are calculated with only white light on, and based on a 4' fixture at 3500K for all optics.

OPTIC	W/FT	LM/FT
HLO-FH	5	200
HLO-FH	7	275
HLO-RG	5	200
HLO-RG	7	275
HLO-0.5D	5	200
HLO-0.5D	7	275
HLO-1.0D	5	200
HLO-1.0D	7	275

OPTIC	W/FT	LM/FT
ARO2	5	225
ARO2	7	300
WRO2	5	225
WRO2	7	300

VIA 2 RECESSED PATTERN

DIRECT

CHROMAWERX - QUADRO - RGBW

Multiple Flange Mounting Details

Multiple flange mounting can be specified when a fixture run needs to have a multiple flange recessed mounting detail. A drawing is required to clearly illustrate the application.

CEILING CONDITION EXAMPLES (consult factory for project specific ceiling conditions)

DRYWALL/GRID

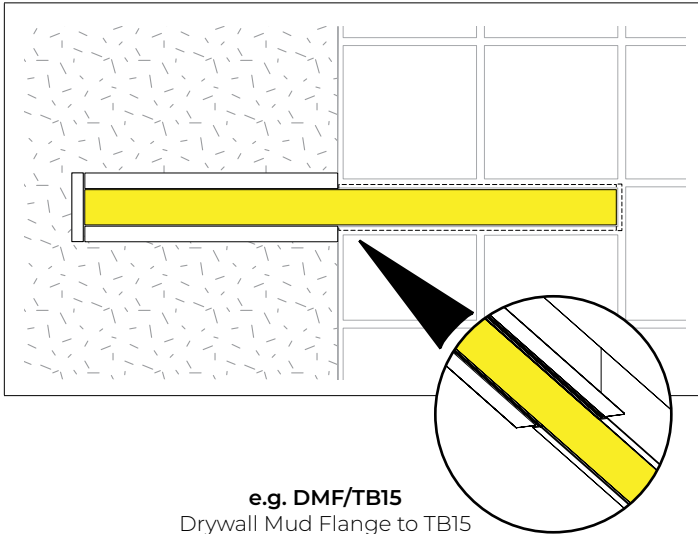

e.g. DMF/TB15
Drywall Mud Flange to TB15

DRYWALL/WOOD

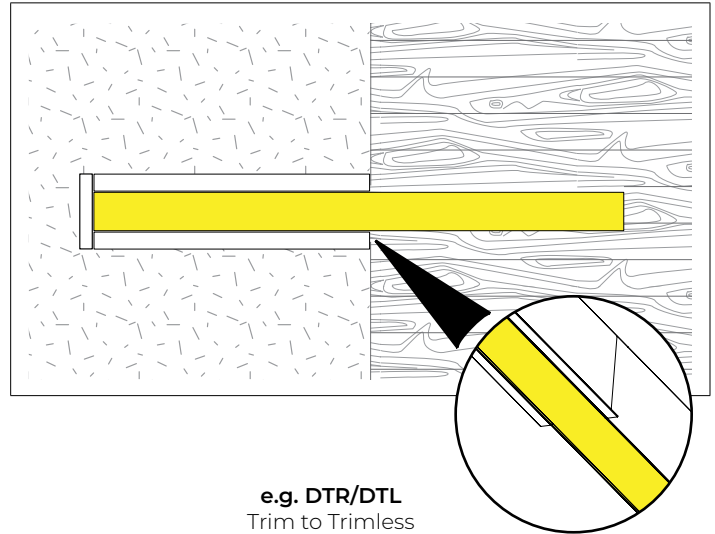

e.g. DTR/DTL
Trim to Trimless

DRYWALL/GRID

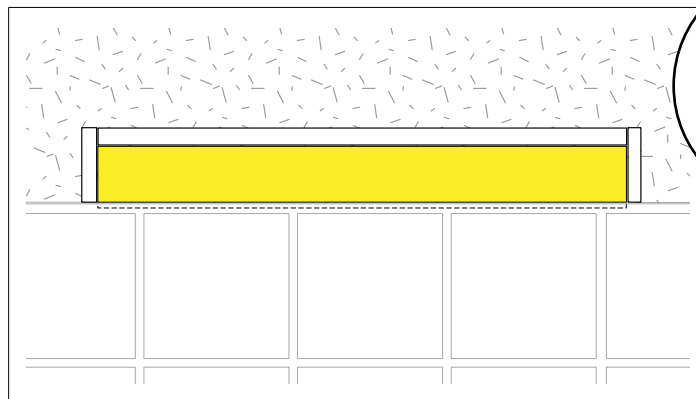

e.g. 1TG9/3DTR
1 long side TG9 and other
3 sides DTR

All drawings are for illustrative purposes only.

TRANSITION MOUNTING OPTIONS (consult factory for details)

Mounting condition alters along the run of the fixture.

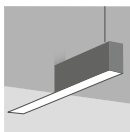

Recessed to Pendant

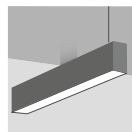

Surface to Pendant

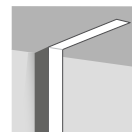

Surface to Recessed in corner

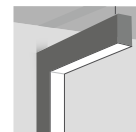

Surface to Pendant in corner

VIA 2 RECESSED PATTERN

DIRECT

CHROMAWERX - QUADRO - RGBW

Pattern Layout

CORNER TYPES

LEVELED CORNERS

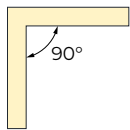

1LEV2C(A90)

2-way

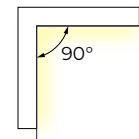

1INN2C(A90)

OUTER CORNER

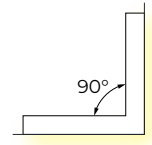

1OUT2C(A90)

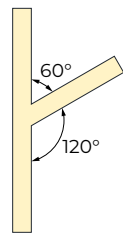

1LEV3C(A60+A120)

3-way

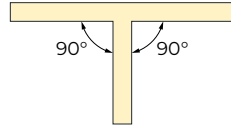

1LEV3C(A90+A90)

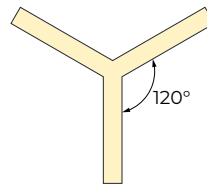

1LEV3C(A120)

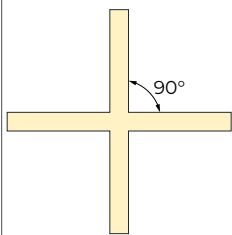

1LEV4C(A90)

4-way

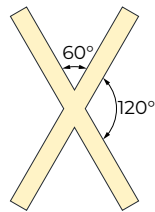

1LEV4C(A60+A120)

EXAMPLES

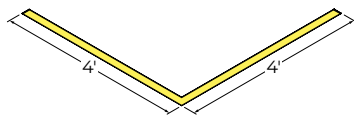

8FT(2X4FT)-1LEV2C(A90)

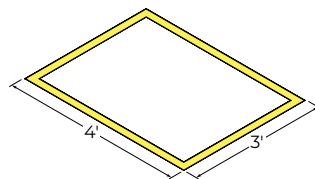

14FT(2X4FT-2X3FT)-4LEV2C(A90)

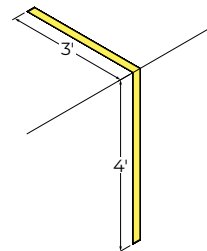

7FT(1X3FT-1X4FT)-1INN2C(A90)

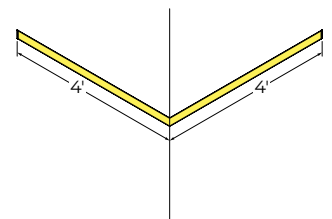

8FT(2X4FT)-1OUT2C(A90)

VIA 2 RECESSED PATTERN



DIRECT

CHROMAWERX - QUADRO - RGBW

Technical Specifications

OPTICS

High-Efficiency Lambertian Optic (HLO)

The High-Efficiency Lambertian Optic (HLO) uses matte white reflectors to distribute LED output across 0.075" acrylic shielding, providing up to 88% transmission and good obscuration.

Available with different lens position options, HLO has a spacing criterion of 1.06.

Asymmetric Refractive Optic (ARO2)

The Asymmetric Refractive Optic (ARO2) uses a sophisticated reflector combined with a matte beam-shaping film to create a smooth, effective downward light component without shadows or hot spots. Microstructure material applied to the snap-in lens provides the precise refractive power and visual comfort, while achieving a high luminous efficacy.

Wall Wash Refractive Optic (WRO2)

The Wall Wash Refractive Optic (WRO2) delivers smooth vertical illumination with a gentle gradient and soft visual cut-off. Its exacting configuration creates a strong downward light component without shadows or hot spots and provides light distribution with peak intensity at 21° above nadir. Microstructure material applied to the snap-in lens provides the precise refractive power and visual comfort, while achieving a high luminous efficacy.

LIGHT SOURCE

Custom linear array of mid-flux LEDs, comprised of an alternation of an RGB and a dedicated white LED. The white LED is used for when a static white CCT is required in the space. RGB LEDs are tightly binned for excellent color control between fixtures. The white LEDs have been tested in accordance with IESNA LM-80-08 and the results have shown L80 lumen maintenance greater than 60,000 hours. Absolute product photometry is measured and presented in accordance with IESNA LM-79, unless otherwise indicated.

Chromawerx QUADRO

Chromawerx QUADRO is a four-channel control that operates an RGBW LED array and addresses the need for more expressive color in architectural applications. The DMX driver supports familiar programming tools for both dynamic multi-hued color and precise white color point control. While a typical user interface will be a DMX controller by others, Lumenwerx also offers a simple control station for stand-alone color changing applications.

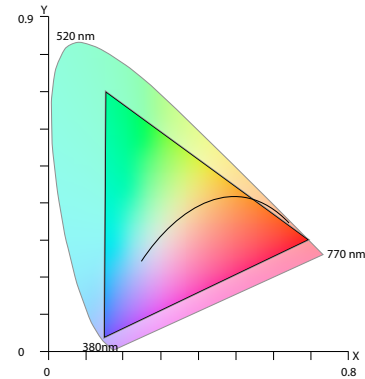

The above diagram overlays the full gamut of colors attainable with the RGBW on top of the CIE 1931 color space. Any color point inside of the triangle can be obtained by setting the correct output levels for each of the individual red, green, blue, and white channels.

PATTERN LENGTH

All individual sections are joined together onsite using the joiner kits provided. Lumenwerx offers joiner kits that are extremely simple to work with in the field and result in a fixture that appears virtually seamless with no light leak at any connection.

ELECTRICAL

DMX

Factory-set, adjustable output current, multi-channel LED driver with universal (120-277 VAC) input. Using DMX wall controls (optionally supplied by Lumenwerx) or an existing DMX control system, four channels of LEDs (Red/Green/Blue/White) are independently adjustable. Each DMX driver has multiple output channels that can be independently addressed at the factory or on-site using built-in RDM (Remote Device Management) functionality. Dimming range from 100%-0%. At maximum driver load, efficiency<89%, PF>0.9, THD<20%.

PoE

Depending on the PoE manufacturer selected, Lumenwerx will install the node in factory as either integral to the luminaire or as a remote module. Factory programming of the PoE node may or may not enable the following functionalities: lumen package, DUO (tunable white), QUADRO (RGBW), emergency battery backup, and sensor integration. These must be addressed and evaluated on a case-by-case basis.

VIA 2 RECESSED PATTERN



DIRECT

CHROMAWERX - QUADRO - RGBW

MOUNTING

Recessed fixtures can be mounted into exposed or concealed T-bar or tegular ceiling, as well as in ceilings with trim, trimless, or mud flange options.

FINISH

Interior: 95% reflective matte powder coated white paint

Exterior: Matte white or matte black powder coating. Custom finishes are also available.

CONSTRUCTION

Housing: Extruded aluminum

Interior brackets: Die-formed cold rolled sheet steel

Joining system: Die-cast zinc

Reflectors: Die-formed cold rolled steel, 95% reflective matte white painted

Lens: Acrylic

Drop lens: Extruded with glued end caps

Recessed flanges: Extruded aluminum

Mud flange: Extruded aluminum

Slip-through bracket: Die-formed galvanized sheet

End plate: Die-formed cold rolled sheet steel

CERTIFICATIONS

ETL: Rated for indoor dry/damp locations. Conforms to UL Standard 1598 and certified to CAN/CSA Standard C22.2 No. 250.0.

Chicago Plenum: City of Chicago Approved (CCEA) when specified with CP option.

IC rated: Suitable for direct contact with insulation

Declare: [LBC Red List Approved](#)

WARRANTY

Lumenwerx provides a five-year limited warranty on electrical and mechanical performance of the luminaires, including the LED boards, drivers, and auxiliary electronics. Lumenwerx will repair or replace defective luminaires or components at our discretion, provided they have been installed and operated in accordance with our specifications. Other limitations apply, please refer to the full warranty on our website.

Wall controllers are covered by the manufacturer warranty.

VIA 2 RECESSED PATTERN

DIRECT

CHROMAWERX - QUADRO - RGBW

QUADRO DMX SPECIFICATION

A qualified DMX integrator is required to assure proper installation and commissioning of the DMX network. **When placing the PO, please provide the contact information of your DMX integrator.**

Please answer the following questions to help us identify your DMX network requirements.

YES

Do you require a wall controller provided by Lumenwerx?

NO

DMX controller supplied by Lumenwerx

DMX control system supplied by others. Lumenwerx will supply DMX-enabled fixtures with default DMX addressing. See following pages for technical DMX informations. ✓

How many zones do you have?

A zone consists of one or more luminaires behaving identically.

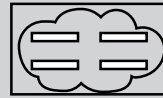

1 Zone



2 Zones

How to calculate the required number of drivers:

per 4' fixture

 Driver
 1x driver
 Less than 12.5W/ft, direct only

per 4' fixture

 Driver Driver
 2x driver
 Above 12.5W/ft or for all direct/indirect fixture

To Calculate # of drivers

1 Zone

2 to 3 Zones

4 or more Zones

Do you have more than 32 drivers in total?

NO

YES

Order a standard Lumenwerx wall controller type 1.

WALL CONTROLLER

WC1W - Single zone wall controller white
WC1B - Single zone wall controller black

Add the control code at the end of your order code.

Please provide a fixture layout or RCP (Reflected Ceiling Plan) showing the locations of the DMX fixtures, zones and the DMX wall controller.

Refer to your DMX integrator for the installation. ✓

Subject to factory evaluation. Please contact our controls specialist at controls@lumenwerx.com. Additional cost and equipment will be required. ✓

NO

YES

Order a standard Lumenwerx wall controller type 2.

WALL CONTROLLER

WC2W - 3 zone wall controller white
WC2B - 3 zone wall controller black

Add the control code at the end of your order code.

Please provide a fixture layout or RCP (Reflected Ceiling Plan) showing the locations of the DMX fixtures, zones and the DMX wall controller.

Refer to your DMX integrator for the installation. ✓

Subject to factory evaluation. Please contact our controls specialist at controls@lumenwerx.com. Additional cost and equipment will be required. ✓

Subject to factory evaluation and approval. Please contact our controls specialist at controls@lumenwerx.com. Additional cost and equipment will be required. ✓

VIA 2 RECESSED PATTERN

DIRECT

CHROMAWERX - QUADRO - RGBW

GENERIC DMX NETWORK ARCHITECTURE

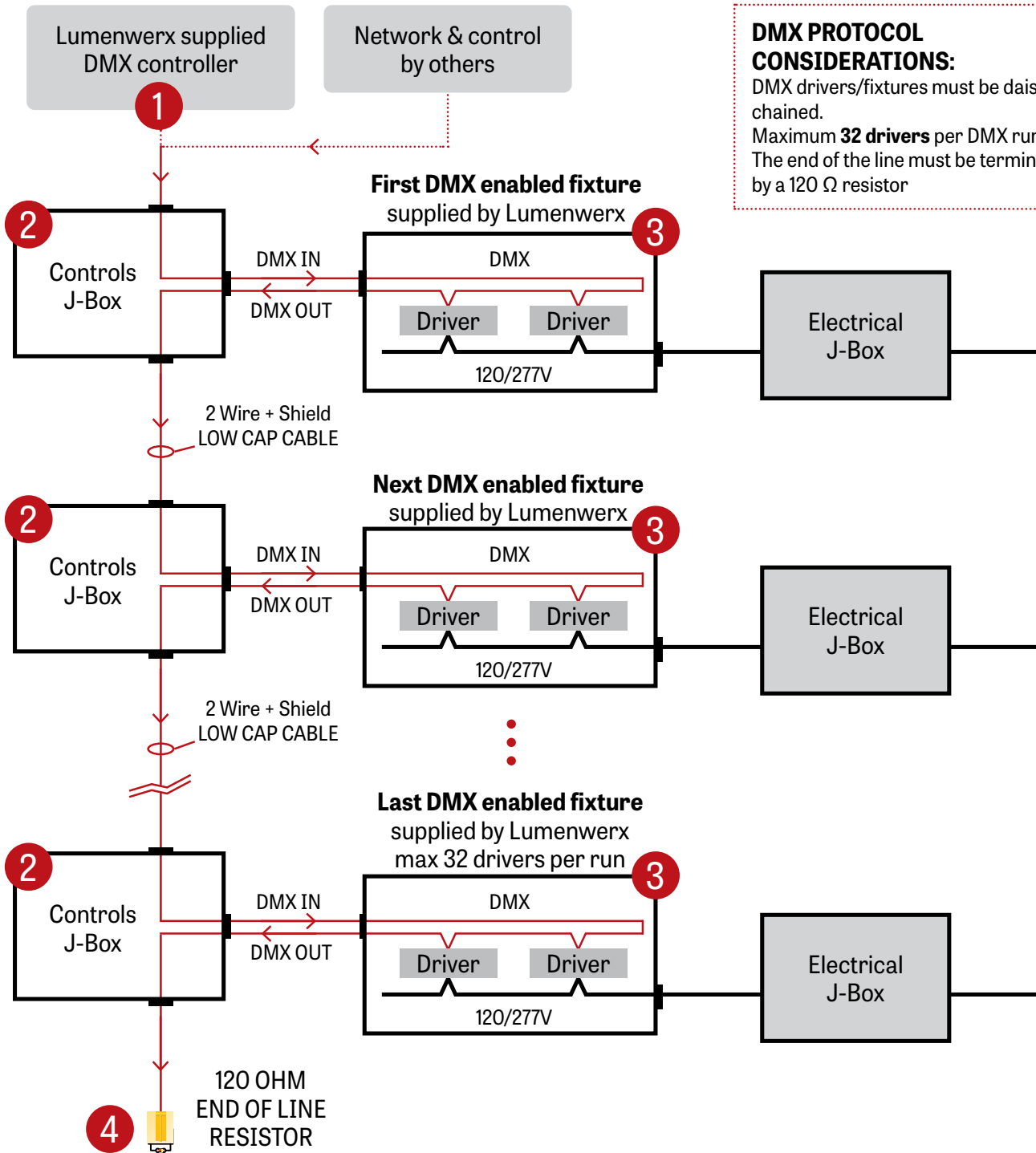

DMX PROTOCOL CONSIDERATIONS:

DMX drivers/fixtures must be daisy chained.
Maximum **32 drivers** per DMX run.
The end of the line must be terminated by a 120 Ω resistor

VIA 2 RECESSED PATTERN

DIRECT

CHROMAWERX - QUADRO - RGBW

1 LUMENWERX SUPPLIED DMX CONTROLLER

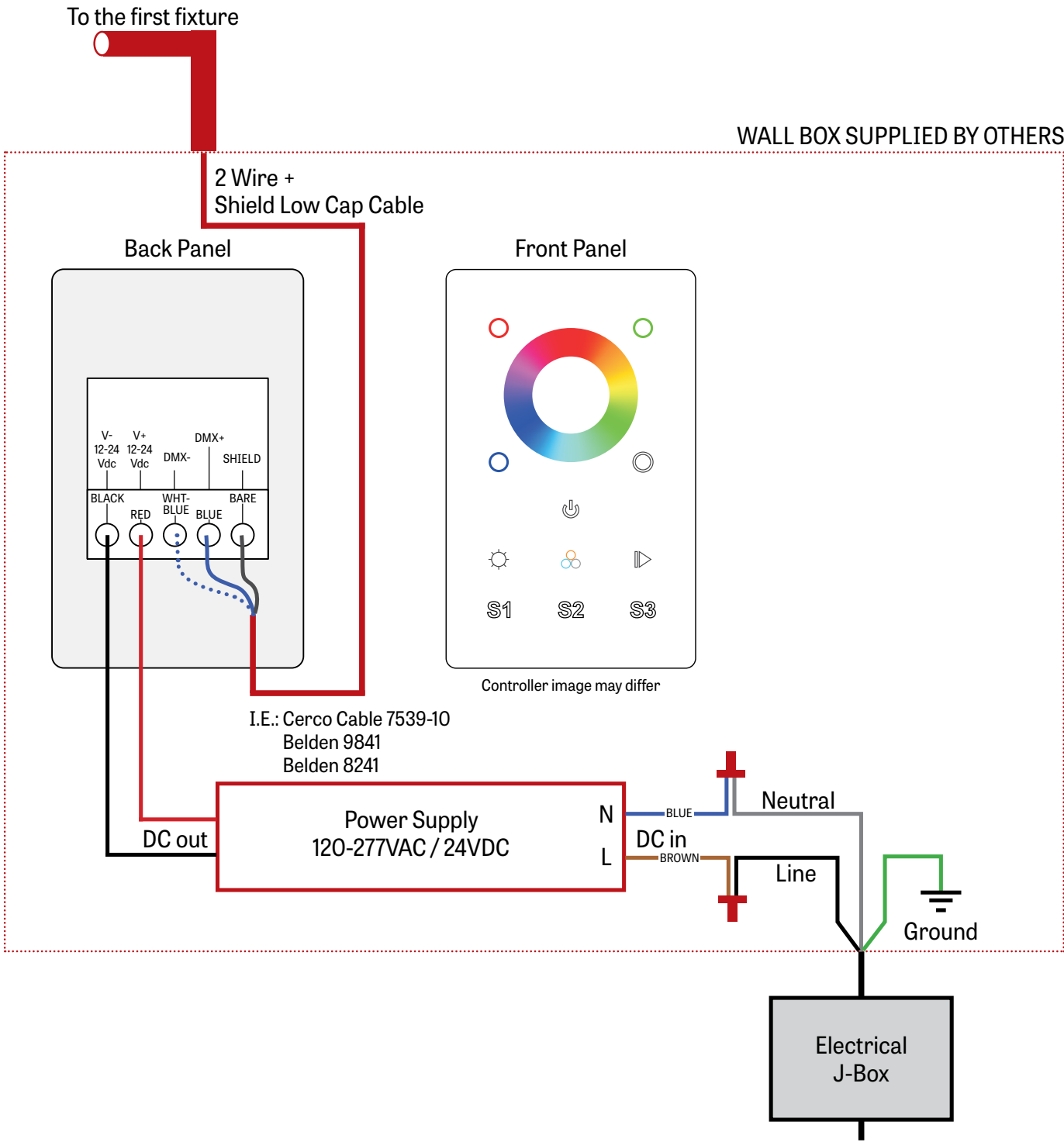

VIA 2 RECESSED PATTERN

DIRECT

CHROMAWERX - QUADRO - RGBW

2 J-BOX DMX DAISY CHAIN DETAIL

Low capacitance DMX Cable from Previous Fixture

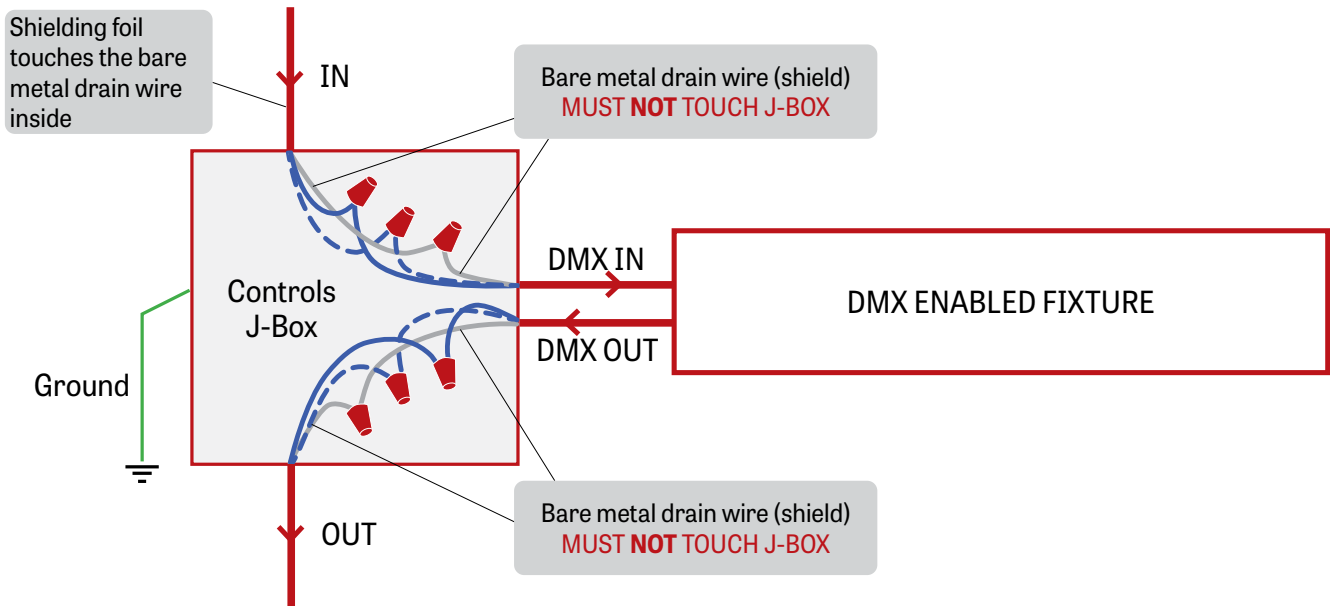

Low capacitance DMX cable to next fixture

3 DMX CONNECTION RECESSED & SURFACE

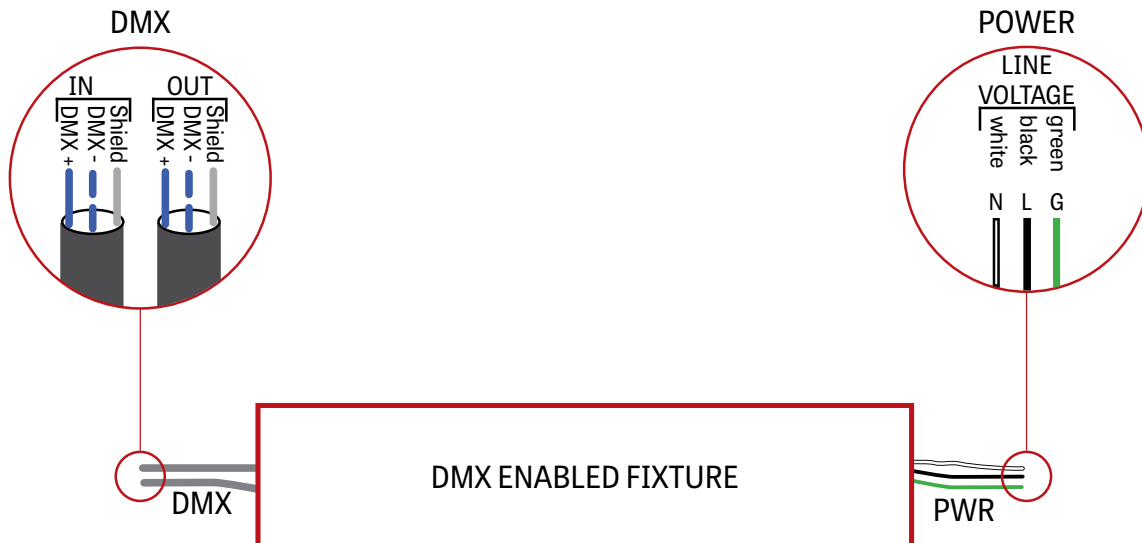

VIA 2 RECESSED PATTERN

DIRECT

CHROMAWERX - QUADRO - RGBW

4 DMX LAST FIXTURE DETAIL

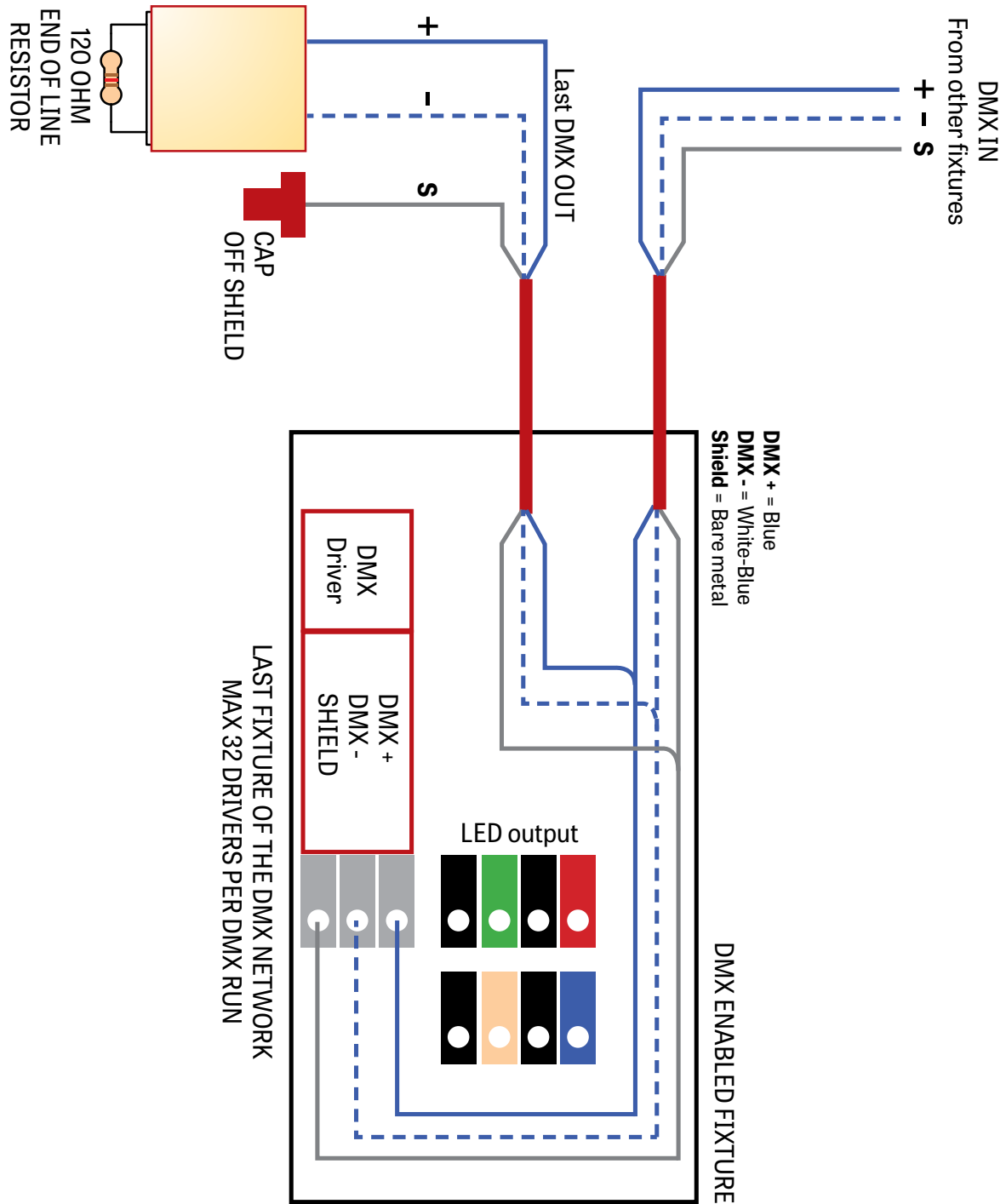

VIA 2 RECESSED PATTERN

DIRECT

CHROMAWERX - QUADRO - RGBW

DMX WALL CONTROLLER

WC1

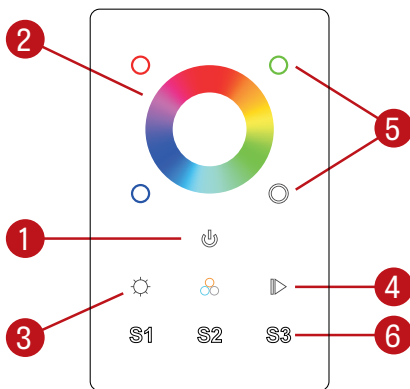

- (1) Power: Use this button to turn ON or OFF the RGBW fixture.
- (2) Color Wheel: The wheel is used to rapidly select a color (RGB colors only).
- (3) Brightness (RGB): Hold down this button to either increase or decrease the brightness of the current RGB selection. White will not be affected by the RGB brightness button.
- (4) Color Cycle: This button will start an animation, rotating between Reds Greens and Blues, the arrows allow the user to speed up or slow down the animation.
- (5) Individual Colors: By pressing and holding a color it will be possible to brighten or dim it. Quickly pressing a color will turn it OFF or turn it ON to its previous dim level.
White: In order to activate or deactivate and dim the White channel, the White button needs to be used.
- (6) Scenes: By holding down one of the scenes button, the current color selection is saved. It can be later accessed by quickly pressing on one of the Scene buttons.

WC2

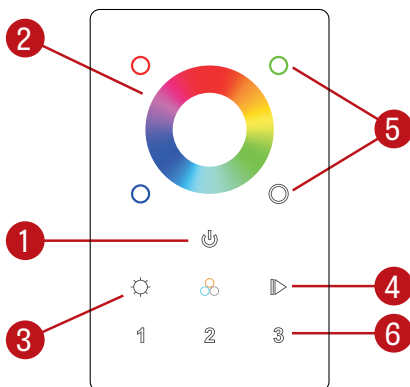

- (1) Power: Use this button to turn ON or OFF the RGBW fixture.
- (2) Color Wheel: The wheel is used to rapidly select a color (RGB colors only).
- (3) Brightness: Hold down this button to either increase or decrease the brightness of the current RGB selection. White will not be affected by the RGB brightness button.
- (4) Color Cycle: This button will start an animation, rotating between Reds Greens and Blues, the arrows allow the user to speed up or slow down the animation.
- (5) Individual Colors: By pressing a color it will be possible to brighten or dim that specific color.
White: In order to activate or deactivate and dim the White channel, the White button needs to be used.
- (6) Zone: By holding down one of the zone buttons, a zone can be selected and controlled.

Default DMX Addresses:

- 1 Red
- 2 Green
- 3 Blue
- 4 White