

# VIA 4 LED

PENDANT DIRECT/INDIRECT



**LUMENWERX**  
WWW.LUMENWERX.COM

## CHROMAWERX TUNABLE WHITE AND DIM TO WARM

**IMPORTANT: a qualified DMX integration consultant is required to ensure proper installation and function of any DMX network**

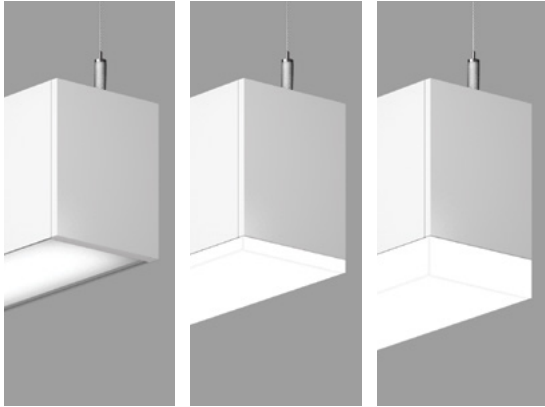

Shown with HLO flush

Shown with HLO 0.5" drop

Shown with HLO 1.5" drop

### DESCRIPTION

Elegant and flexible, the Via 4 Direct/Indirect pendant features the option of our Widespread Indirect Optics for smooth ceiling brightness. Via 4 Direct/Indirect can be configured in discrete luminaires, continuous runs, and patterns, with a wide range of lumen packages, color choices, and electrical and controls options. Via 4 Direct/Indirect is part of the larger Via family, which includes visually coordinated recessed and mounted luminaires, as well as other light distributions, including wall washing and asymmetric optics. Via 4 is an ideal vehicle for ChromaWerx white tuning in education, office, and healthcare applications where modular luminaires are used.

**PROJECT:** \_\_\_\_\_

**TYPE:** \_\_\_\_\_

**NOTES:** \_\_\_\_\_

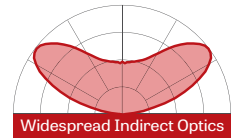

Widespread Indirect Optics

### ORDER GUIDE

**up to 110 lm/w performance**

VIA4PDI	HLO			LED		
LUMINAIRE ID	DIRECT OPTICS	LENS POSITION	INDIRECT OPTICS	LIGHT SOURCE	CRI	DIRECT LUMEN PACKAGES
VIA4PDI - via 4" pendant direct/indirect	HLO - High-Efficiency Lambertian Optic	FH - Flush 0.5D - 0.5" drop 1.5D - 1.5" drop	WIO - Widespread indirect optics CLO - Clear Lambertian Optic	LED - high performance LED	80 - 80CRI 90 - 90CRI	500 - min. low output 500lm/ft 750 - medium output 750lm/ft 1000 - high output 1000lm/ft 1200 - max. ultra high output 1200lm/ft #### - other required lm/ft

IND. LUMEN PACKAGES	CHROMAWERX	LUMINAIRE LENGTH	VOLTAGE	DRIVER
500 - min. low output 500lm/ft #### - other required lm/ft	DUO - tunable white 2 channel control 27k to 65k SOLA - dim to warm single channel control 22k to 35k	Available sections - 4', 6', 8', 10' & 12' #FT - nominal length in feet #IN - length in inches (not available in WIO) (2' increments only) Continuous Run - for luminaires over 12' Minimum Individual section 4'	120 - 120V 277 - 277V	DMX - to specify see pages 7 to 12 DA - Dali (duo only) local on-site commissioning is required O-10 - Single 0-10V input (Sola) or dual 0-10V input for CCT/Intensity (Duo) PSQO - Lutron T-Series 1% Tunable White (Duo only)

1	5WAC36		
ELECTRICAL	MOUNTING	FINISH	OPTIONS
1 - 1 circuit	53WAC36 - power 5" + non power 3" white canopy (36" air craft cable) <a href="#">For all other options refer to our Pendant Mounting Guide</a>	W - matte white AL - aluminum B - matte black CF# - custom finish specify RAL#	FU - fuse TB# - T-bar caddy clip specify grid size TG# - Tegular caddy clip specify grid size ST - Screw Slots caddy clip CU - custom

**DMX WALL CONTROLS**  
To specify see pages 7 to 12

### CROSS SECTION

See page 2 for ordering code detailed information

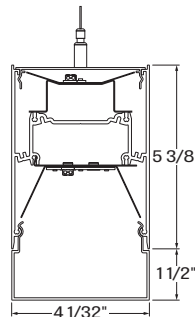
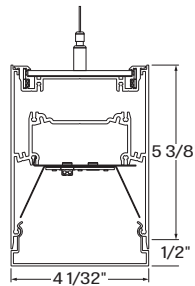
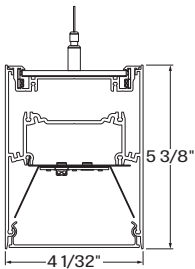

VIA4PDI - HLO-WIO

VIA4PDI - HLO-0.5D-WIO

VIA4PDI - HLO-1.5D-CLO

File Name: VIA4-TW-PENDANT-DIRECT-INDIRECT-SPEC

Page: 1 / 12

September 20, 2019



### CHROMAWERX TUNABLE WHITE AND DIM TO WARM

#### PHOTOMETRICS

Please follow the multiplier tables to ensure correct lumen value. Lensing, CCT and CRI, will change the lumen output.

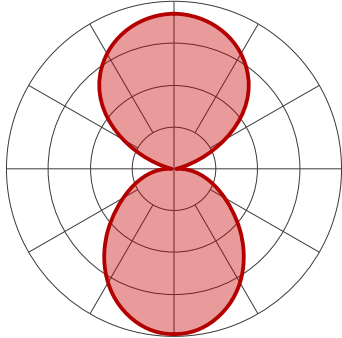

HLO-FH-CLO

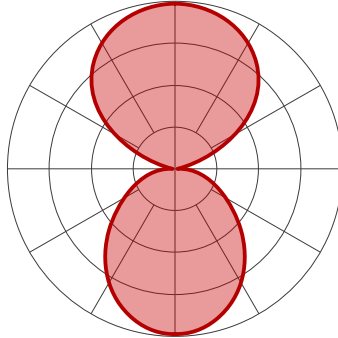

HLO-0.5D-CLO

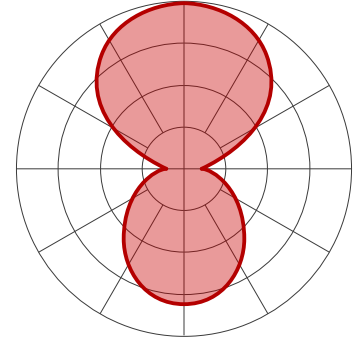

HLO-1.5D-CLO

#### HLO-FH-CLO Delivered Lumens for Flush at 35K 80CRI

Lumen Package (Direct + Indirect)	Direct	Indirect	Total Lumens Per 4FT	Input Watts	LPW
500+500	2000	2000	4000	36.5	110
750+500	3000	2000	5000	45.5	110
1000+500	4000	2000	6000	56	107
1200+500	4800	2000	6800	64	106

#### Multiplier - Drop Lens

Direct lens	Watts Multiplier	LPW Multiplier
Flush lens	1.00	1.00
Drop lens 0.5"	0.98	1.02
Drop lens 1.5"	0.96	1.05

#### Multiplier - CCT/CRI

CCT (K)	Watts Multiplier		LPW Multiplier	
	CRI80	CRI90	CRI80	CRI90
2700	1.05	1.26	0.95	0.79
3000	1.01	1.23	0.99	0.81
3500	1.00	1.20	1.00	0.84
4000	1.00	1.17	1.00	0.85
5000	0.90	1.09	1.11	0.92
6500	0.94	1.11	1.06	0.90

### CHROMAWERX TUNABLE WHITE AND DIM TO WARM

#### PHOTOMETRICS

Please follow the multiplier tables to ensure correct lumen value. Lensing, CCT and CRI, will change the lumen output.

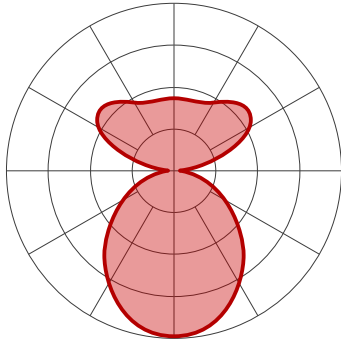

HLO-FH-WIO

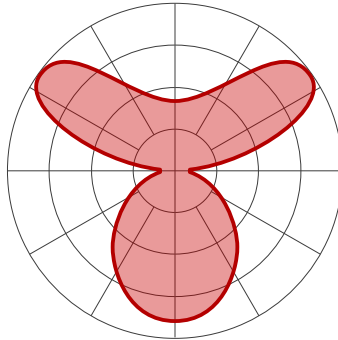

HLO-0.5D-WIO

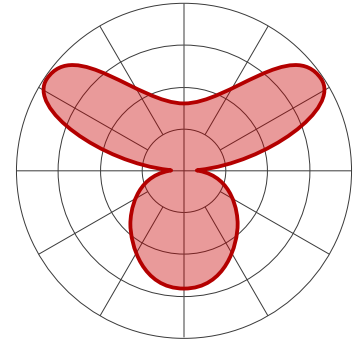

HLO-1.5D-WIO

#### HLO-FH-WIO Delivered Lumens for Flush at 35K 80CRI

Lumen Package (Direct + Indirect)	Direct	Indirect	Total Lumens Per 4FT	Input Watts	LPW
500+500	2000	2000	4000	42.5	94
750+500	3000	2000	5000	51.5	97
1000+500	4000	2000	6000	62	97
1200+500	4800	2000	6800	70	97

#### Multiplier - Drop Lens

Direct lens	Watts Multiplier	LPW Multiplier
Flush lens	1.00	1.00
Drop lens 0.5"	0.98	1.02
Drop lens 1.5"	0.96	1.05

#### Multiplier - CCT/CRI

CCT (K)	Watts Multiplier		LPW Multiplier	
	CRI80	CRI90	CRI80	CRI90
2700	1.05	1.26	0.95	0.79
3000	1.01	1.23	0.99	0.81
3500	1.00	1.20	1.00	0.84
4000	1.00	1.17	1.00	0.85
5000	0.90	1.09	1.11	0.92
6500	0.94	1.11	1.06	0.90

#### DIRECT OPTICS

**High Efficiency Lambertian Optic (HLO)** shielding of diffusing 0.075" thick acrylic provides up to 88% transmission and good source obscuration. Matte white reflectors distribute LED output across the shielding. Luminaire brightness is controlled by the ratio of luminous flux to shielding area. HLO is available as a flush diffuser or as a drop diffuser, extending 0.5" or 1.5" below the luminaire housing. Drop diffusers are extruded with glued end caps. HLO optics have a Spacing Criteria of 1.16.

#### INDIRECT OPTICS

The LumenWerx **Widespread Indirect Optics (WIO)** uses two vertically oriented LED arrays that couple light into the edges of a linear light guide. A specially designed TIR/microstructure extracts light into the desired "batwing" distribution. Peak intensity hits at 125° while suppressing direct uplight. Peak-to-zenith intensity ratio is 2:1, outstanding for a narrow luminaire. The Widespread Indirect Optic produces noticeably smoother ceiling brightness than a typical lambertian uplight distribution, permitting generally wider spacing as well.

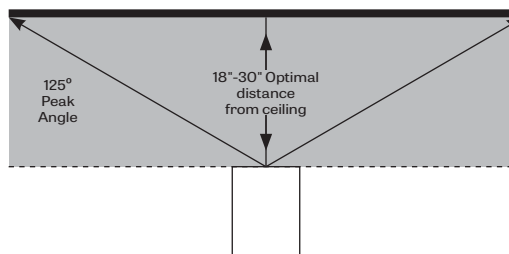

### CHROMAWERX TUNABLE WHITE AND DIM TO WARM

The **Clear Lambertian Optic (CLO)** uses a single horizontal LED array and a clear acrylic cover to provide simple uplight with high efficiency.

#### SPACE CALCULATION

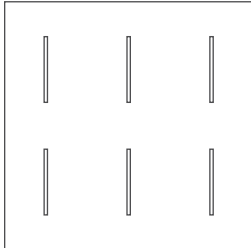

Room: 36'Wx36'Lx12'H  
Suspension: 36"  
Fixture spacing: 12'x18'

VIA4PDI-HLO-FH-WIO-LED-80-500-500-40-4FT

Direct Lumen Output: 500 lm/ft  
Indirect Lumen Output: 500 lm/ft  
Efficacy: 95LPW  
LLF: 0.9  
LPD: 0.588Watt/Sq.Ft.

#### For Workplane:

Avg Illuminance = 38.74FC  
Uniformity Max/Min = 2.52  
Uniformity Avg/Min = 1.75

#### For Ceiling:

Avg Illuminance = 31.22FC  
Uniformity Max/Min = 3.78  
Uniformity Avg/Min = 2.25

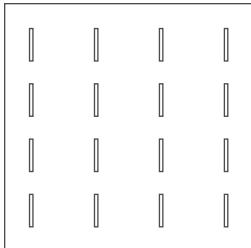

Room: 30'Wx30'Lx12'H  
Suspension: 36"  
Fixture spacing: 8'x8'

VIA4PDI-HLO-FH-CLO-LED-80-750-500-40-4FT

Direct Lumen Output: 750 lm/ft  
Indirect Lumen Output: 500 lm/ft  
Efficacy: 110LPW  
LLF: 0.9  
LPD: 0.809Watt/Sq.Ft.

#### For Workplane:

Avg Illuminance = 56.94FC  
Uniformity Max/Min = 1.73  
Uniformity Avg/Min = 1.45

#### For Ceiling:

Avg Illuminance = 40.42FC  
Uniformity Max/Min = 2.95  
Uniformity Avg/Min = 1.68

#### LIGHT SOURCE - LED

Custom linear array of alternating color temperature mid-flux LED's are mounted directly to the housing for optimal thermal performance. For the Duo products, a color temperature range from 2700K-6500K is achievable with color points on or below the black body curve. For the Sola products, a color temperature range from 2200K-3500K is controlled synchronously with intensity. Color consistency between fixtures is maintained to within 3SDCM. LEDs are operated at reduced drive current to optimize efficacy and lumen maintenance.

All LED's have been tested in accordance with IESNA LM-80-08 and the results have shown L80 lumen maintenance greater than 60,000 hours. Absolute product photometry is measured and presented in accordance with IESNA LM-79, unless otherwise indicated.

#### LUMINAIRE LENGTH

Via 4 is made up of standard 4, 6, 8, 10 and 12 foot sections that may be joined together to create longer continuous run lengths. Exact run length must be noted in the product code. The minimum individual section available is 4 foot, and continuous run lengths can be ordered in 2 foot increments.

All individual sections are joined together onsite using the joiner kits provided. LumenWerx offers joiner kits that are extremely simple to work with in the field and result in a fixture that appears virtually seamless with no light leak at any connection.

#### Joining system

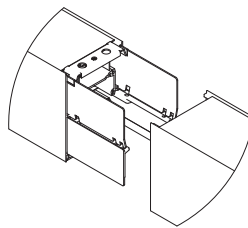

Via 4 direct/indirect CLO

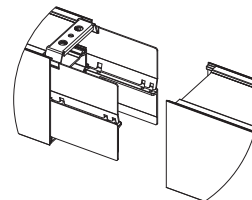

Via 4 direct/indirect  
Wide Spread

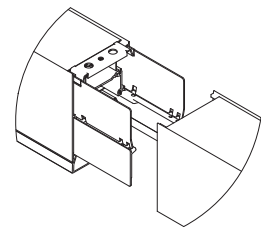

Via 4 direct/indirect  
with drop lens

## CHROMAWERX TUNABLE WHITE AND DIM TO WARM

### CHROMAWERX - TUNABLE WHITE

#### ANSI C78.377-2015

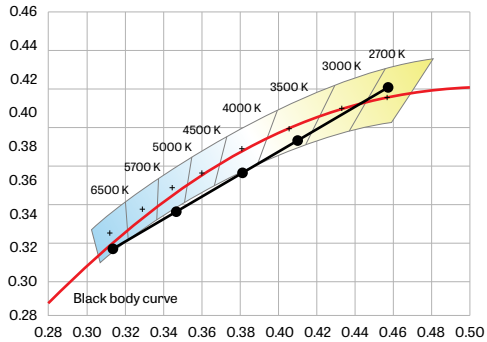

**ChromaWerx Sola** is single-channel control that dims output while warming the color temperature in a pre-determined relationship. A simple digital or analog control sends a common signal to dual output digital drivers, which are programmed to adjust a specially populated LED array to emulate the effect of dimming a filament source. Dimming range is programmable but the default option runs from 3500K at 100% of full power to 2200K at 5% of full power. CRI is maintained above 80 throughout the dimming range.

**ChromaWerx Duo** is two-channel control. It uses an analog (0-10V) protocol for separate control of luminaire CCT and intensity or a digital (DMX, DALI) protocol for synchronous control of both warm and cool LED arrays to enable the user to set color temperature and light output. Commonly called "tunable white", ChromaWerx two-channel control provides the range of warm (2700K) to cool (6500K) color that can be useful for helping to entrain circadian rhythms, stimulate alertness for improved educational and work productivity, and compensate for jet lag, among other applications. The ChromaWerx drivers are programmed to limit maximum light output and power usage across all color temperatures. CRI is maintained above 80.

### ELECTRICAL

#### DMX (Duo only)

Factory-Set adjustable output current electronic driver with 120-277V AC line input. Using DMX wall controls (optionally supplied by Lumenwerx) or an existing DMX control system, both channels of LEDs are independently adjustable. Each DMX driver can be independently addressed using the built-in RDM (Remote Device Management) in the field. Dimming down to 1% is attainable. Rated life (90% survivorship) of 50,000 hours at 50°C maximum ambient temperature. At maximum driver load, efficiency<84%, PF>0.9, THD<20%.

#### Dali (Duo Only)

Factory-Set adjustable output current electronic driver with 120-277V AC line input. Using an existing DALI control system (supplied by others), one control channel adjusts the fixture color temperature, and the other control channel adjusts fixture brightness. Dimming down to 1% is attainable. Rated life (90% survivorship) of 50,000 hours at 50°C maximum ambient temperature. At maximum driver load, efficiency<84%, PF>0.9, THD<20%.

#### 0-10V (Sola)

Factory-set, adjustable output current LED driver with universal (120-277VAC) input. Using a single 0-10V control signal, the light output warms in color temperature as it dims down to 1% and 2200K. At maximum driver load, efficiency<86%, PF>0.9, THD<20%.

#### 0-10V (Duo)

Factory-set adjustable output current LED driver with universal (120-277VAC) input. Controlled via two individual 0-10V signals, one for setting light output down to a minimum of 1% and the other for adjusting the CCT (default range of 2700K-6500K). Rated life of 50,000 hours at 70°C maximum driver case temperature and 100% load conditions. Typical efficiency of 86%, PF>0.9, THD<20% at 100% load conditions.

#### PSQ0 (Duo only)

Lutron T-Series 2-Channel tunable white drivers enable high-performance human centric lighting (HCL) applications. Digital control of color temperature (CCT) and intensity are achieved when used with the ESN T-Series tunable white controller as a part of a Lutron Quantum System.

### MOUNTING OPTIONS

Fixtures can be pendant-mounted, using aircraft cables.

Unless otherwise specified, LumenWerx provides the following hardware:

**For cable-mounted fixtures** - 53WAC36 (5" white canopy for all power mounting point, 3" white canopy for non power mounting point, and a 36" cable)

**Caddy clips**, if required specify under **OPTIONS**

[For all other options, see our website for a detailed Pendant Mounting Guide](#)

### FINISH

**Interior** - 95%, reflective matte powder coated white paint

**Exterior** - matte white, matte black or aluminum powder coating.

Custom finishes are also available.

## CHROMAWERX TUNABLE WHITE AND DIM TO WARM

**CONSTRUCTION**

**Housing** - Extruded Aluminum (0.095" nominal) up to 90% Recycled Content

**Interior brackets** - Die formed cold rolled sheet steel 18 gauge thick

**Joining system** - Die cast Zinc (0.95" nominal)

**Reflectors** - Cold rolled steel 0.024" thick precisely die formed, 95% reflective matte white painted

**Light guide** - Clear PMMA Laminated with microstructure film formed into optical TIR/extraction form

**End caps** - Die cast Aluminum (0.95" nominal)

**Hanger** - Chromed Griplock securely attached with spring steel hardware in end caps and/or joiners

**Air craft cable suspension** - 7x7 braids Aluminum air craft cable 0.06" thick

**WEIGHT**

**Via 4 4ft** - 13.66lbs - 6.2kg

**Via 4 8ft** - 27.53lbs - 12.5kg

**Via 4 12ft** - 41.41lbs - 18.8kg

**CERTIFICATIONS**

**ETL** - Rated for Indoor Dry/Damp locations.

Conforms to UL Standard 1598 and certified to CAN/CSA Standard C22.2 No. 250.0.

**WARRANTY**

For all ChromaWerx products, LumenWerx provides a three-year limited warranty of electrical and mechanical performance of the luminaires, including the LED boards, drivers, and auxiliary electronics.

LumenWerx will repair or replace defective luminaires or components at our discretion, provided they have been installed and operated in accordance with our specifications. Other limitations apply, please refer to the full warranty on our website.

Wall controllers are covered by the manufacturer warranty.

CHROMAWERX TUNABLE WHITE

DUO DMX SPECIFICATION

A qualified DMX integrator is required to assure proper installation and commissioning of the DMX network. **When placing the PO, please provide the contact information of your DMX integrator.**

Please answer the following questions to help us identify your DMX network requirements.

YES

Do you require a wall controller provided by Lumenwerx?

NO

DMX control system supplied by others. Lumenwerx will supply DMX-enabled fixtures with default DMX addressing. See following pages for technical DMX informations. ✓

DMX controller supplied by Lumenwerx

**How many zones do you have?**  
A zone consists of one or more luminaires behaving identically.



1 Zone



2 Zones

**How to calculate the required number of drivers:**

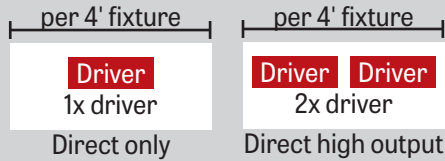

To Calculate # of drivers

1 - 4 Zones

5 or more Zones

Do you have more than 32 drivers in total?

NO

YES

Order a standard Lumenwerx wall controller.

**WALL CONTROLLER**

**WCW** - wall controller white  
**WCB** - wall controller black

Add the control code at the end of your order code. Please provide a fixture layout or RCP (Reflected Ceiling Plan) showing the locations of the DMX fixtures, zones and the DMX wall controller. Refer to your DMX integrator for the installation. ✓

Subject to factory evaluation. Please contact our controls specialist at controls@lumenwerx.com Additional cost and equipment will be required. ✓

Subject to factory evaluation and approval. Please contact our controls specialist at controls@lumenwerx.com Additional cost and equipment will be required. ✓

CHROMAWERX TUNABLE WHITE

GENERIC DMX NETWORK ARCHITECTURE

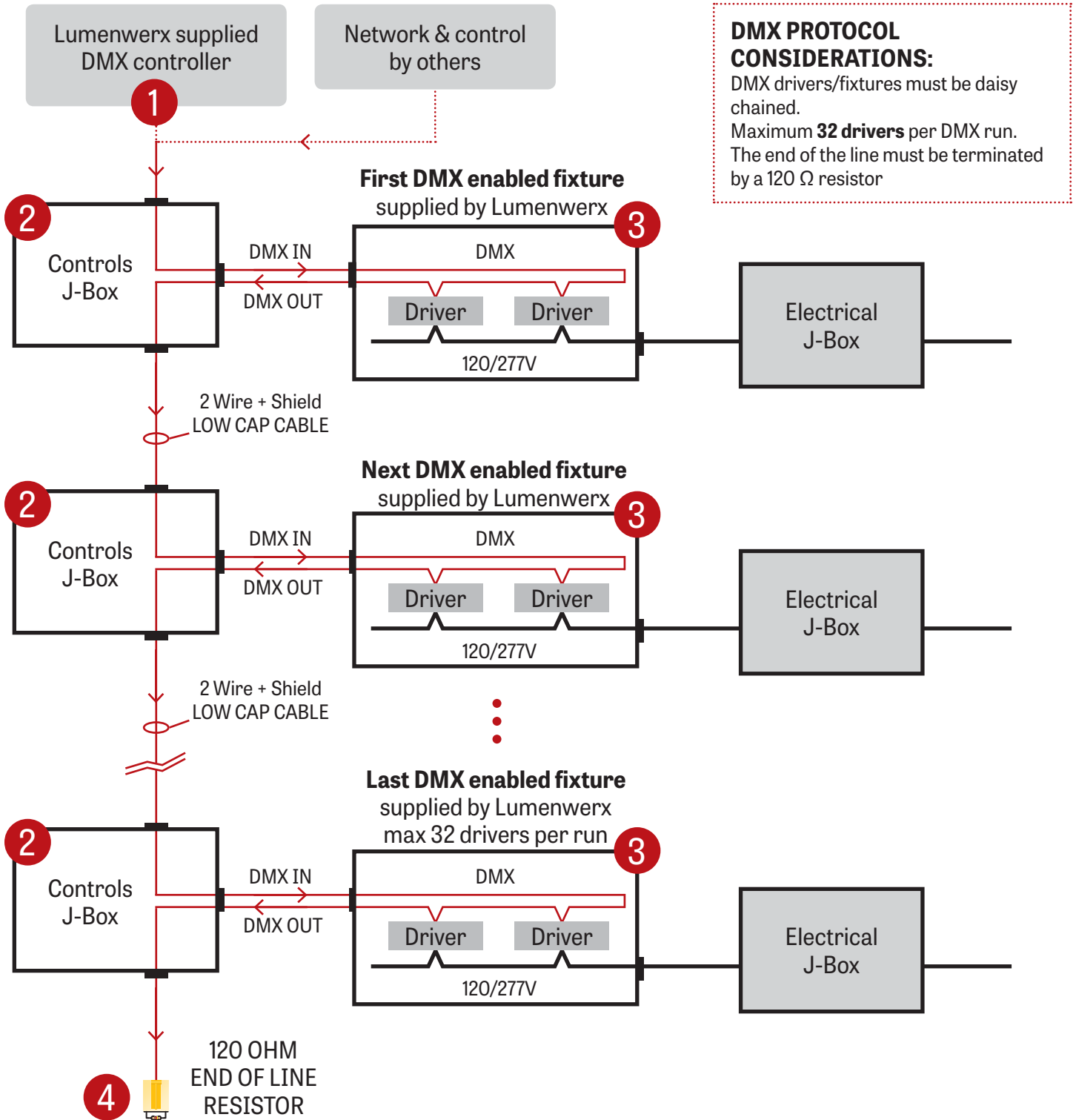

**DMX PROTOCOL CONSIDERATIONS:**  
DMX drivers/fixtures must be daisy chained.  
Maximum **32 drivers** per DMX run.  
The end of the line must be terminated by a 120 Ω resistor



CHROMAWERX TUNABLE WHITE

1 LUMENWERX SUPPLIED DMX CONTROLLER

To the first fixture

WALL BOX SUPPLIED BY OTHERS

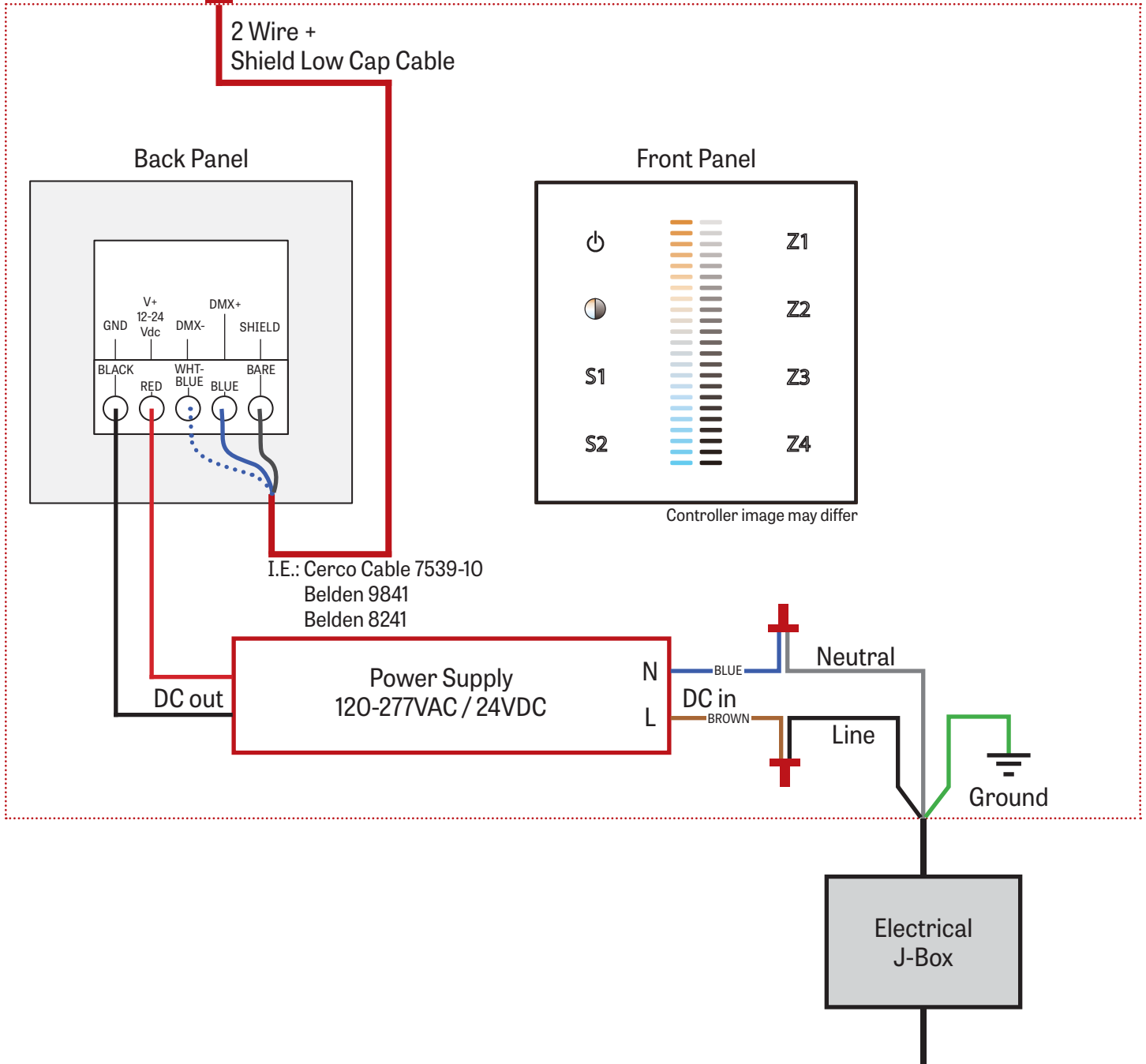

CHROMAWERX TUNABLE WHITE

2 J-BOX DMX DAISY CHAIN DETAIL

Low capacitance DMX Cable from Previous Fixture

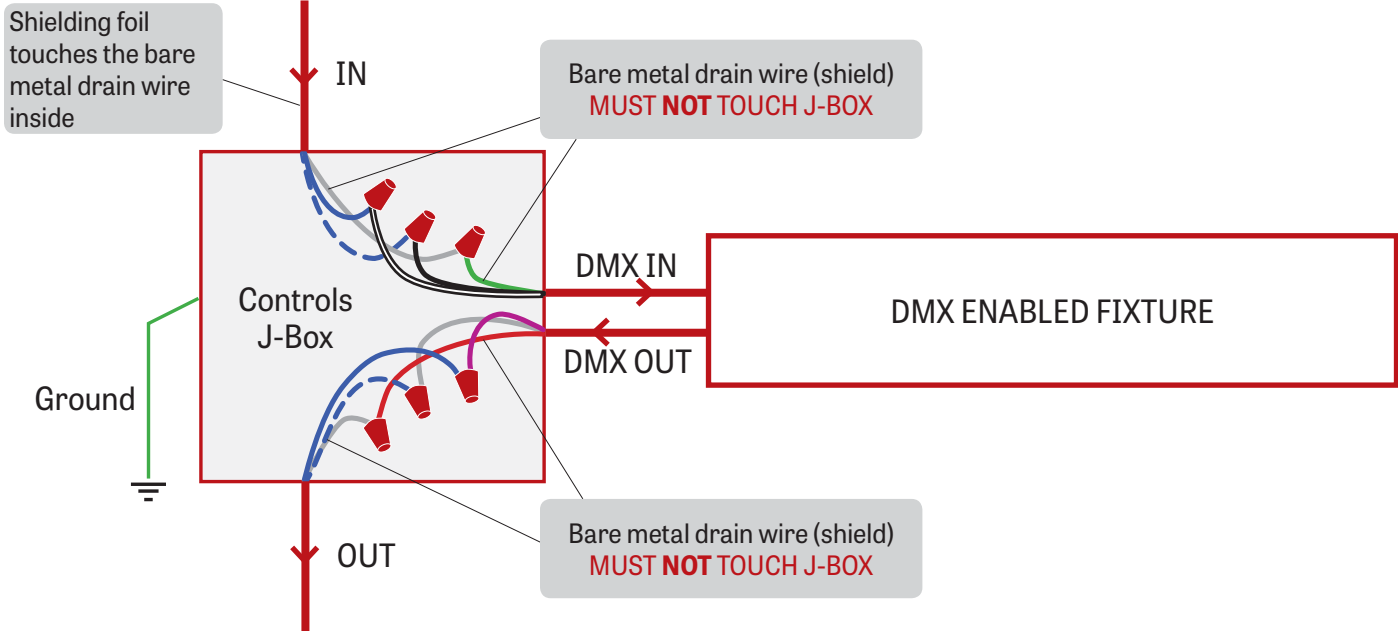

Low capacitance DMX cable to next fixture

3 DMX CONNECTION PENDANT & WALL

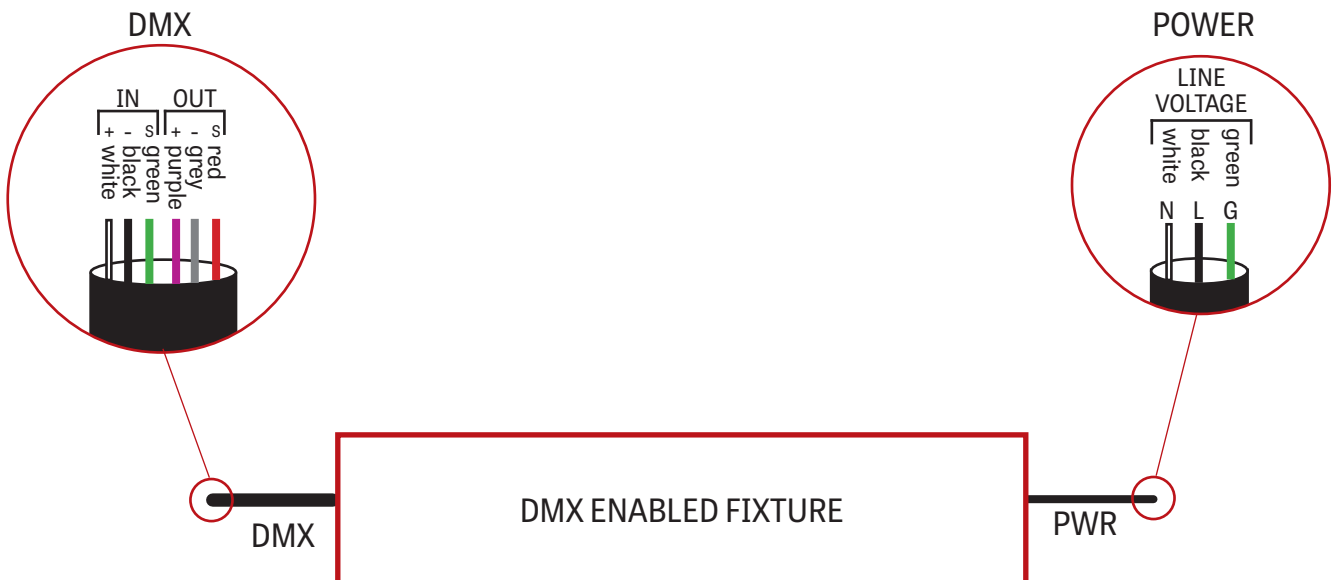

CHROMAWERX TUNABLE WHITE

4 DMX LAST FIXTURE DETAIL

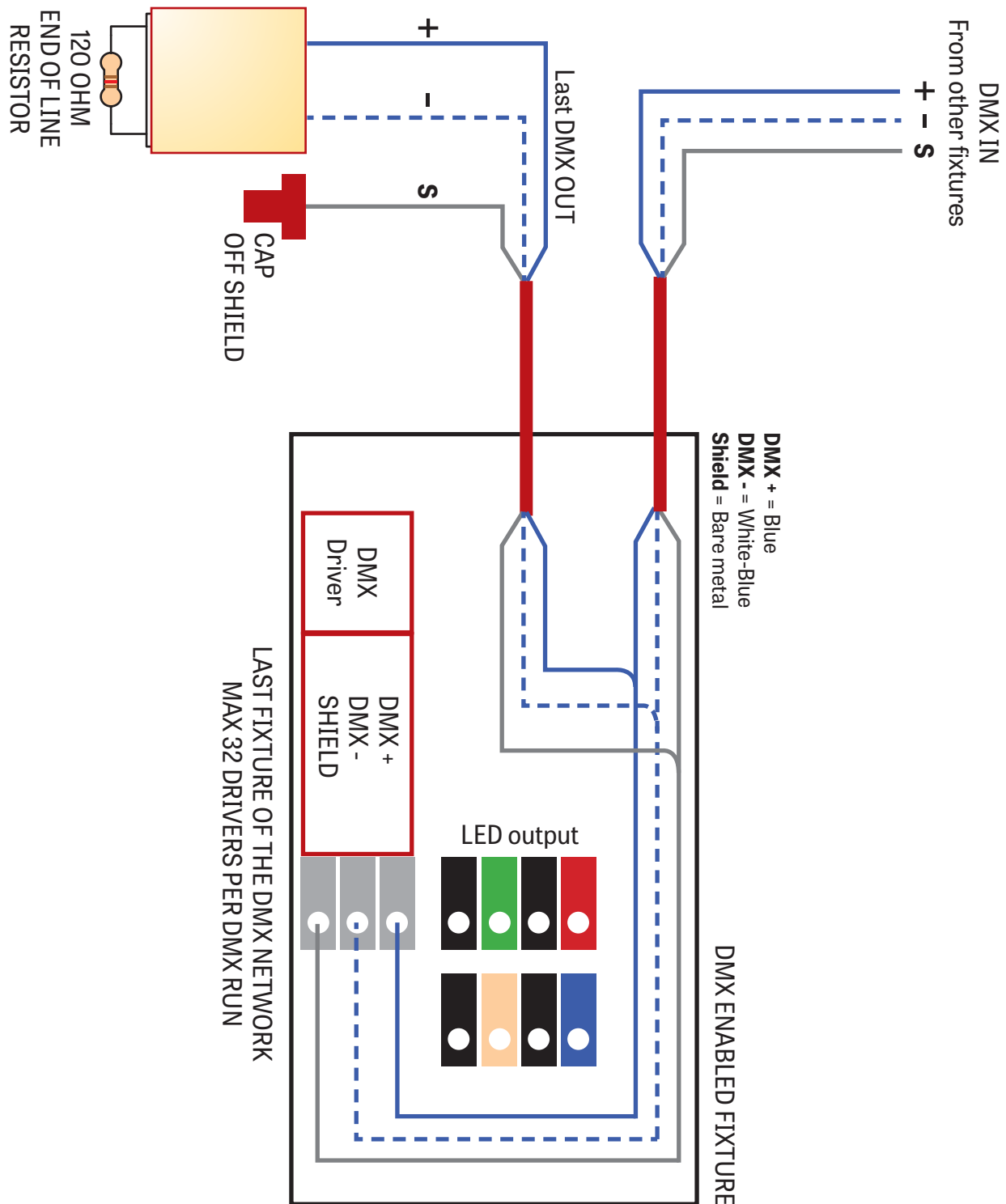

CHROMAWERX TUNABLE WHITE

DMX WALL CONTROLLER

DUO 1-4 ZONE

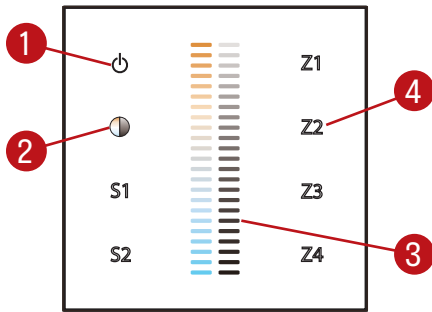

- (1) Power: Use this button to turn ON or OFF the fixture
- (2) Brightness/CCT: Use the color/brightness toggle button to chose between color/brightness. when Blue: brightness is selected, when Yellow: color is selected.
- (3) Slider: Depending on the mode chosen in 2, the slider will allow the user to set desired color or brightness.
- (4) Zone select: Up to 4 zones can be selected either independently or together. Once selected the commands will be sent to the zone identified by a Blue LED.

Default DMX Addresses:

- 1 Warm
- 2 Cool