

VIA 4 LED

RECESSED WALL WASH V. 2



LUMENWERX
WWW.LUMENWERX.COM

CHROMAWERX TUNABLE WHITE AND DIM TO WARM

IMPORTANT: a qualified DMX integration consultant is required to ensure proper installation and function of any DMX network

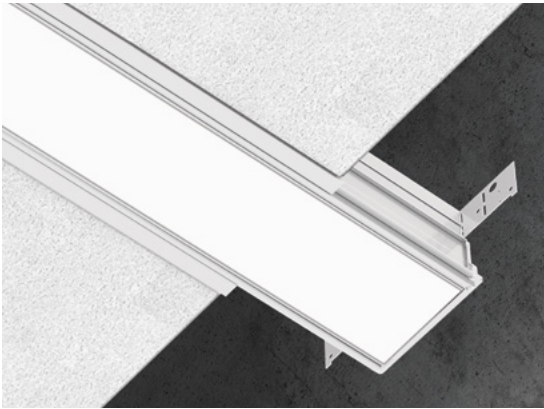

Grid - shown with WRO2 optics

DESCRIPTION

Elegant and flexible, the Via 4 Recessed Wall Wash features our Asymmetrical Lens Optic for smooth, comfortable and efficient illumination of vertical surfaces. Via 4 Recessed Wall Wash offers a wide range of lumen packages, color choices, mounting and electrical and controls options.

It is part of the larger Via family, which includes visually coordinated recessed and mounted luminaires, as well as other light distributions, including wall washing and asymmetric optics. Via 4 is an ideal vehicle for ChromaWerx white tuning in education, office, and healthcare applications where modular luminaires are used.

PROJECT: _____

TYPE: _____
NOTES: _____



up to 105 lm/w performance

ORDER GUIDE

IC RATED

VIA4R	WRO2	LED			
LUMINAIRE ID	OPTICS	LIGHT SOURCE	CRI	LUMEN PACKAGES	CHROMAWERX
VIA4R - via 4" recessed	WRO2 - wallwash refractive optic version 2	LED - high performance LED	80 - 80CRI 90 - 90CRI	375 - min. low output 375lm/ft 500 - medium output 500lm/ft 750 - max. high output 750lm/ft #### - other required lm/ft	DUO - tunable white 2 channel control 27k to 65k SOLA - dim to warm single channel control 22k to 35k

LUMINAIRE LENGTH	VOLTAGE	DRIVER	ELECTRICAL	MOUNTING	FINISH
Available sections - 4', 6', 8', 10' & 12' #FT - nominal length in feet (2' increments only) Continuous Run - for luminaires over 12' Minimum Individual section 4'	120 - 120V 277 - 277V	DMX - to specify see pages 6 to 11 DA - Dali (duo only) local on-site commissioning is required O-10 - Single 0-10V input (Sola) or dual 0-10V input for CCT/Intensity (Duo) PSQO - Lutron T-Series 1% Tunable White (Duo only)	1 - 1 circuit	TG9 - tegular 9/16" TG15 - tegular 15/16" TB9 - t-bar 9/16" TB15 - t-bar 15/16" ST - screw slot t-bar DTR - drywall trim DTL - drywall trimless DMF - drywall mud flange	W - matte white CF# - custom finish specify RAL#

See page 2 for ordering code detailed information

OPTIONS

- FU - fuse
- FWC - flexible whip cable (6' std)
- CP - Chicago Plenum
- CU - custom

DMX WALL CONTROLS

To specify see pages 6 to 11

CROSS SECTION

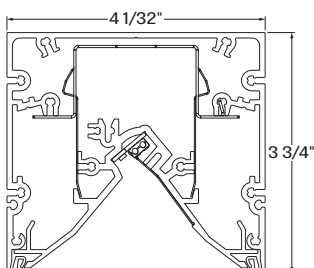

VIA4R - wall wash



CHROMAWERX TUNABLE WHITE AND DIM TO WARM

PHOTOMETRICS

Please follow the multiplier tables to ensure correct lumen value. Lensing, CCT and CRI, will change the lumen output.

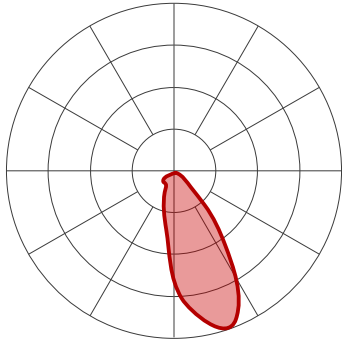

WRO2

WRO2 Delivered Lumens for Flush at 35K 80CRI

Lumens per Foot	Total Lumens Per 4FT	Input Watts	LPW
375	1500	14.5	104
500	2000	19.5	103
750	3000	28.5	105

Multiplier - CCT/CRI

CCT (K)	Watts Multiplier		LPW Multiplier	
	CRI80	CRI90	CRI80	CRI90
2700	1.05	1.26	0.95	0.79
3000	1.01	1.23	0.99	0.81
3500	1.00	1.20	1.00	0.84
4000	1.00	1.17	1.00	0.85
5000	0.90	1.09	1.11	0.92
6500	0.94	1.11	1.06	0.90

OPTICS

WALLWASH REFRACTIVE OPTIC V. 2 (WRO2) - The LumenWerx Wallwash Refractive Optic V. 2 (WRO2) delivers smooth vertical illumination with a gentle gradient and soft visual cut off. With peak intensity at 21° above nadir, the precise WRO2 configuration creates a strong downward component without shadows or hot spots. No external shielding is required. Microstructure material applied to the snap-in lens provides the precise refractive power and visual comfort, while achieving high luminous efficacy of 105 lumens per watt.

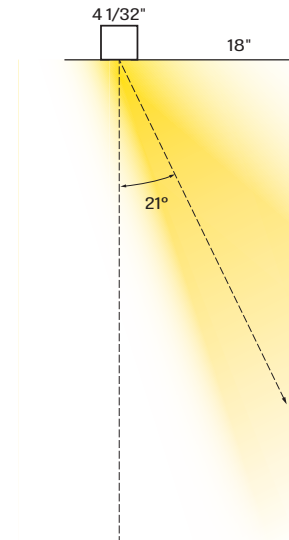

Avg.	Max	Min	Avg/Min	Max/Min
33.39	65.3	13.9	2.40	4.70

CHROMAWERX TUNABLE WHITE AND DIM TO WARM

LIGHT SOURCE - LED

Custom linear array of alternating color temperature mid-flux LED's are mounted directly to the housing for optimal thermal performance. For the Duo products, a color temperature range from 2700K-6500K is achievable with color points on or below the black body curve. For the Sola products, a color temperature range from 2200K-3500K is controlled synchronously with intensity. Color consistency between fixtures is maintained to within 3SDCM. LEDs are operated at reduced drive current to optimize efficacy and lumen maintenance.

All LED's have been tested in accordance with IESNA LM-80-08 and the results have shown L80 lumen maintenance greater than 60,000 hours. Absolute product photometry is measured and presented in accordance with IESNA LM-79, unless otherwise indicated.

LUMINAIRE LENGTH

Via 4 is made up of standard 4, 6, 8, 10 and 12 foot sections that may be joined together to create longer continuous run lengths. Exact run length must be noted in the product code. The minimum individual section available is 4 foot, and continuous run lengths can be ordered in 2 foot increments.

All individual sections are joined together onsite using the joiner kits provided. LumenWerx offers joiner kits that are extremely simple to work with in the field and result in a fixture that appears virtually seamless with no light leak at any connection.

Joining system

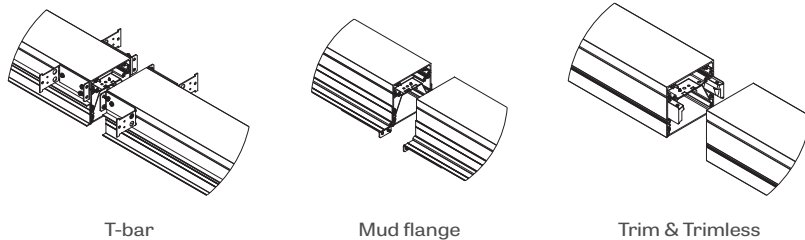

CHROMAWERX - TUNABLE WHITE

ANSI C78.377-2015

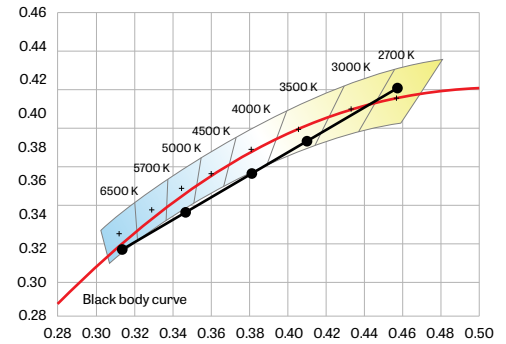

ChromaWerx Sola is single-channel control that dims output while warming the color temperature in a pre-determined relationship. A simple digital or analog control sends a common signal to dual output digital drivers, which are programmed to adjust a specially populated LED array to emulate the effect of dimming a filament source. Dimming range is programmable but the default option runs from 3500K at 100% of full power to 2200K at 5% of full power. CRI is maintained above 80 throughout the dimming range.

ChromaWerx Duo is two-channel control. It uses an analog (0-10V) protocol for separate control of luminaire CCT and intensity or a digital (DMX, DALI) protocol for synchronous control of both warm and cool LED arrays to enable the user to set color temperature and light output. Commonly called "tunable white", ChromaWerx two-channel control provides the range of warm (2700K) to cool (6500K) color that can be useful for helping to entrain circadian rhythms, stimulate alertness for improved educational and work productivity, and compensate for jet lag, among other applications. The ChromaWerx drivers are programmed to limit maximum light output and power usage across all color temperatures. CRI is maintained above 80.

CHROMAWERX TUNABLE WHITE AND DIM TO WARM

ELECTRICAL

DMX (Duo only)

Factory-Set adjustable output current electronic driver with 120-277V AC line input. Using DMX wall controls (optionally supplied by Lumenwerx) or an existing DMX control system, both channels of LEDs are independently adjustable. Each DMX driver can be independently addressed using the built-in RDM (Remote Device Management) in the field. Dimming down to 1% is attainable. Rated life (90% survivorship) of 50,000 hours at 50°C maximum ambient temperature. At maximum driver load, efficiency < 84%, PF > 0.9, THD < 20%.

Dali (Duo Only)

Factory-Set adjustable output current electronic driver with 120-277V AC line input. Using an existing DALI control system (supplied by others), one control channel adjusts the fixture color temperature, and the other control channel adjusts fixture brightness. Dimming down to 1% is attainable. Rated life (90% survivorship) of 50,000 hours at 50°C maximum ambient temperature. At maximum driver load, efficiency < 84%, PF > 0.9, THD < 20%.

0-10V (Sola)

Factory-set, adjustable output current LED driver with universal (120-277VAC) input. Using a single 0-10V control signal, the light output warms in color temperature as it dims down to 1% and 2200K. At maximum driver load, efficiency < 86%, PF > 0.9, THD < 20%.

0-10V (Duo)

Factory-set adjustable output current LED driver with universal (120-277VAC) input. Controlled via two individual 0-10V signals, one for setting light output down to a minimum of 1% and the other for adjusting the CCT (default range of 2700K-6500K). Rated life of 50,000 hours at 70°C maximum driver case temperature and 100% load conditions. Typical efficiency of 86%, PF > 0.9, THD < 20% at 100% load conditions.

PSQ0 (Duo only)

Lutron T-Series 2-Channel tunable white drivers enable high-performance human centric lighting (HCL) applications. Digital control of color temperature (CCT) and intensity are achieved when used with the ESN T-Series tunable white controller as a part of a Lutron Quantum System.

MOUNTING OPTIONS

Recess mount into exposed or concealed Grid or Tegular grid ceiling

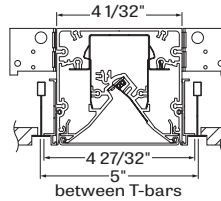

TG9 - tegular 9/16"

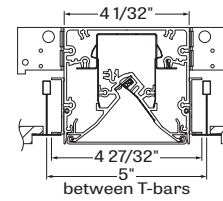

TG15 - tegular 15/16"

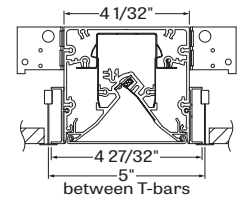

TB9 - t-bar 9/16"

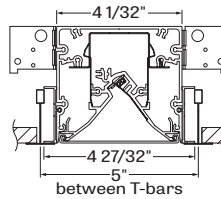

TB15 - t-bar 15/16"

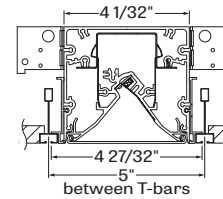

ST - screw slot t-bar

Mounting for drywall ceilings are available with visible trim, mud flange trim or trimless

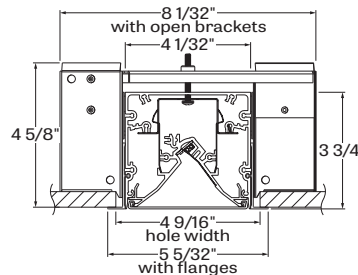

DTR - drywall trim

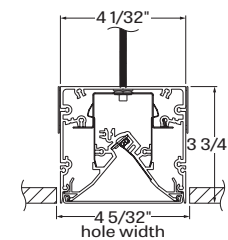

DTL - drywall trimless

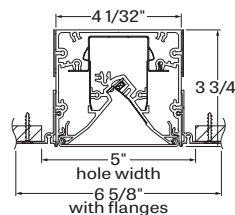

DMF - drywall mud flange

FINISH

Interior - 95%, reflective matte powder coated white paint

Exterior - matte white powder coating.

Custom finishes are also available.

CHROMAWERX TUNABLE WHITE AND DIM TO WARM
CONSTRUCTION

Housing - Extruded Aluminum (0.095" nominal) up to 90% Recycled Content

Interior brackets - Die formed cold rolled sheet steel 20 gauge thick

Joining system - Die cast Zinc (0.95" nominal) and die Formed galvanized sheet 18 gauge

Reflectors - Extruded Aluminum (0.080" nominal) thickness/Painted White.

Specular reflectors - Semi-specular anodized aluminum sheet 0.020" thickness

Lens - Extruded Clear Acrylic 0,050" nominal thickness.

Recessed flanges - Extruded Aluminum (0.075" nominal) up to 90% Recycled Content

Mud flange - Extruded Aluminum (0.075" nominal) up to 90% Recycled Content

Slip-through bracket - Die Formed galvanized sheet 18 gauge

End plate - Die formed cold rolled sheet steel 18 gauge thick

WEIGHT

Via 4 4ft - 11.23lbs - 5.1kg

Via 4 8ft - 22.47lbs - 10.2kg

Via 4 12ft - 33.70lbs - 15.3kg

CERTIFICATIONS

ETL - Rated for Indoor Dry/Damp locations. Conforms to UL Standard 1598 and certified to CAN/CSA Standard C22.2 No. 250.0.

Chicago plenum - City of Chicago Approved (CCEA)

IC rated - suitable for direct contact with insulation.

WARRANTY

For all ChromaWerx products, LumenWerx provides a three-year limited warranty of electrical and mechanical performance of the luminaires, including the LED boards, drivers, and auxiliary electronics. LumenWerx will repair or replace defective luminaires or components at our discretion, provided they have been installed and operated in accordance with our specifications. Other limitations apply, please refer to the full warranty on our website.

Wall controllers are covered by the manufacturer warranty.

CHROMAWERX TUNABLE WHITE

DUO DMX SPECIFICATION

A qualified DMX integrator is required to assure proper installation and commissioning of the DMX network. **When placing the PO, please provide the contact information of your DMX integrator.**

Please answer the following questions to help us identify your DMX network requirements.

YES

Do you require a wall controller provided by Lumenwerx?

NO

DMX control system supplied by others. Lumenwerx will supply DMX-enabled fixtures with default DMX addressing. See following pages for technical DMX informations. ✓

DMX controller supplied by Lumenwerx

How many zones do you have?
A zone consists of one or more luminaires behaving identically.



1 Zone



2 Zones

How to calculate the required number of drivers:

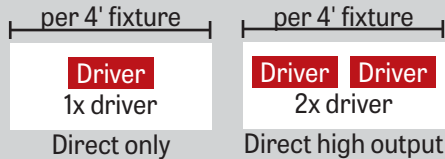

To Calculate # of drivers

1 - 4 Zones

5 or more Zones

Do you have more than 32 drivers in total?

NO

YES

Order a standard Lumenwerx wall controller.

WALL CONTROLLER

WCW - wall controller white
WCB - wall controller black

Add the control code at the end of your order code. Please provide a fixture layout or RCP (Reflected Ceiling Plan) showing the locations of the DMX fixtures, zones and the DMX wall controller. Refer to your DMX integrator for the installation. ✓

Subject to factory evaluation. Please contact our controls specialist at controls@lumenwerx.com Additional cost and equipment will be required. ✓

Subject to factory evaluation and approval. Please contact our controls specialist at controls@lumenwerx.com Additional cost and equipment will be required. ✓

CHROMAWERX TUNABLE WHITE

GENERIC DMX NETWORK ARCHITECTURE

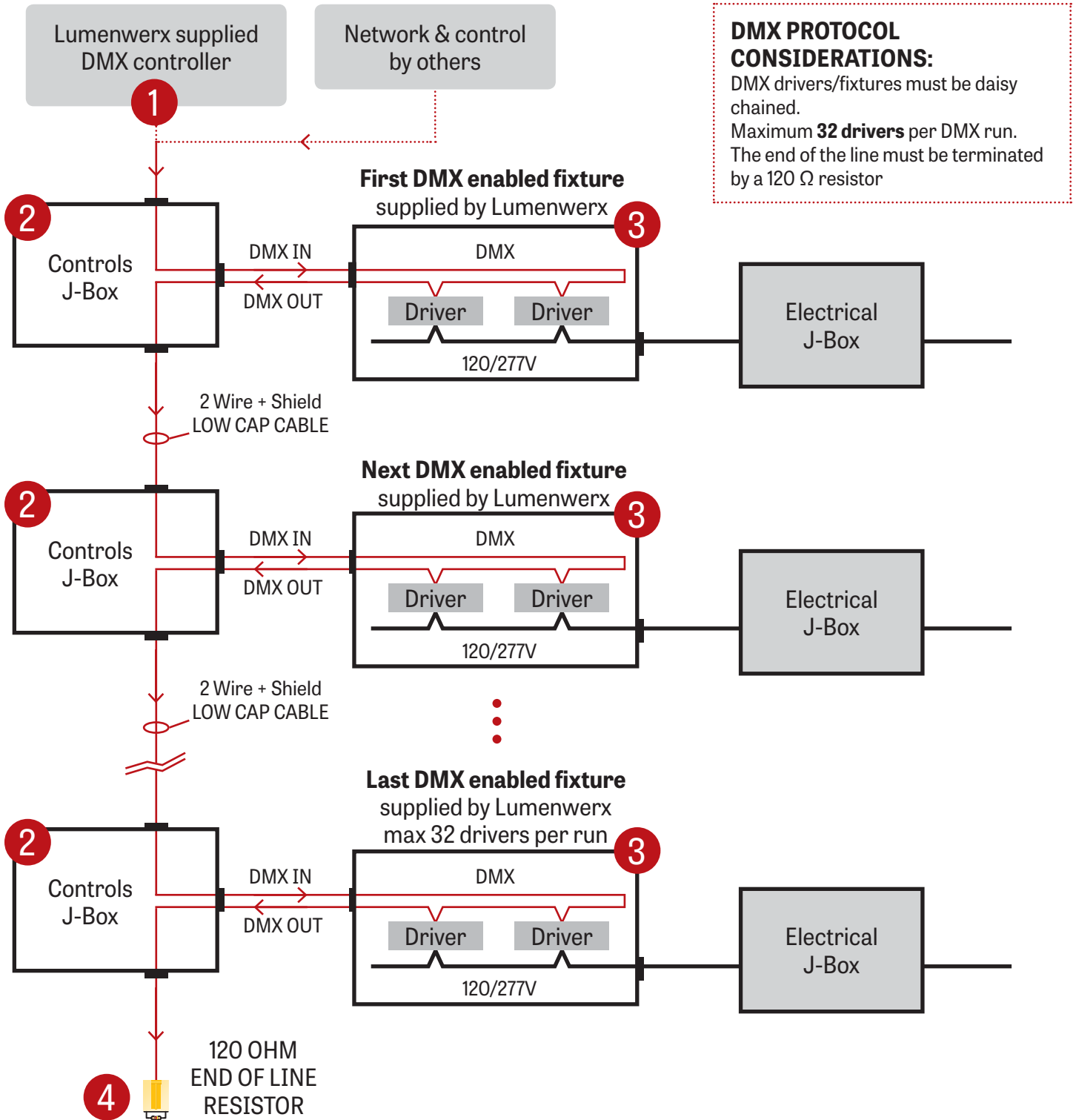

DMX PROTOCOL CONSIDERATIONS:
DMX drivers/fixtures must be daisy chained.
Maximum **32 drivers** per DMX run.
The end of the line must be terminated by a 120 Ω resistor

CHROMAWERX TUNABLE WHITE

1 LUMENWERX SUPPLIED DMX CONTROLLER

To the first fixture

WALL BOX SUPPLIED BY OTHERS

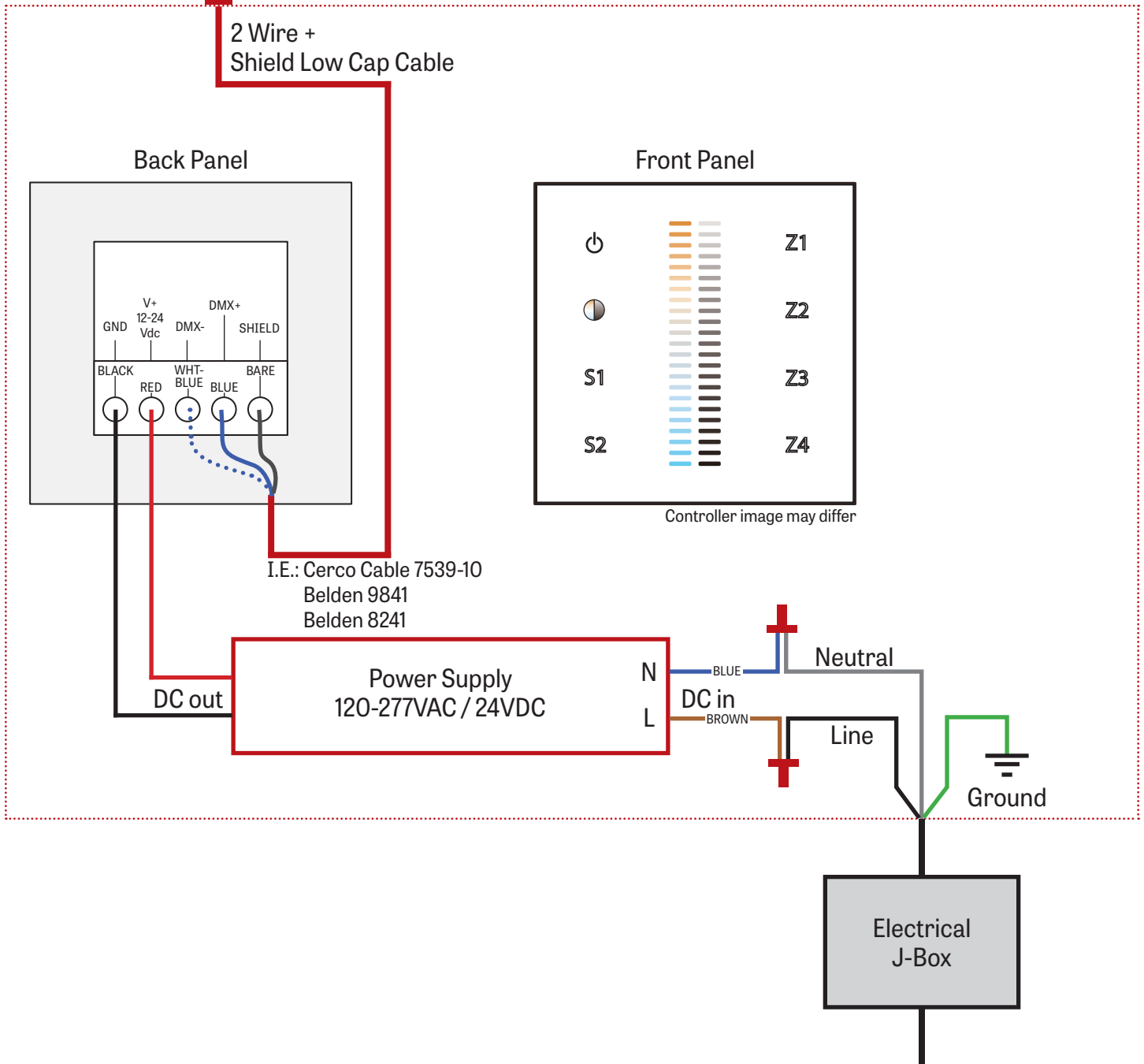

CHROMAWERX TUNABLE WHITE

2 J-BOX DMX DAISY CHAIN DETAIL

Low capacitance DMX Cable from Previous Fixture

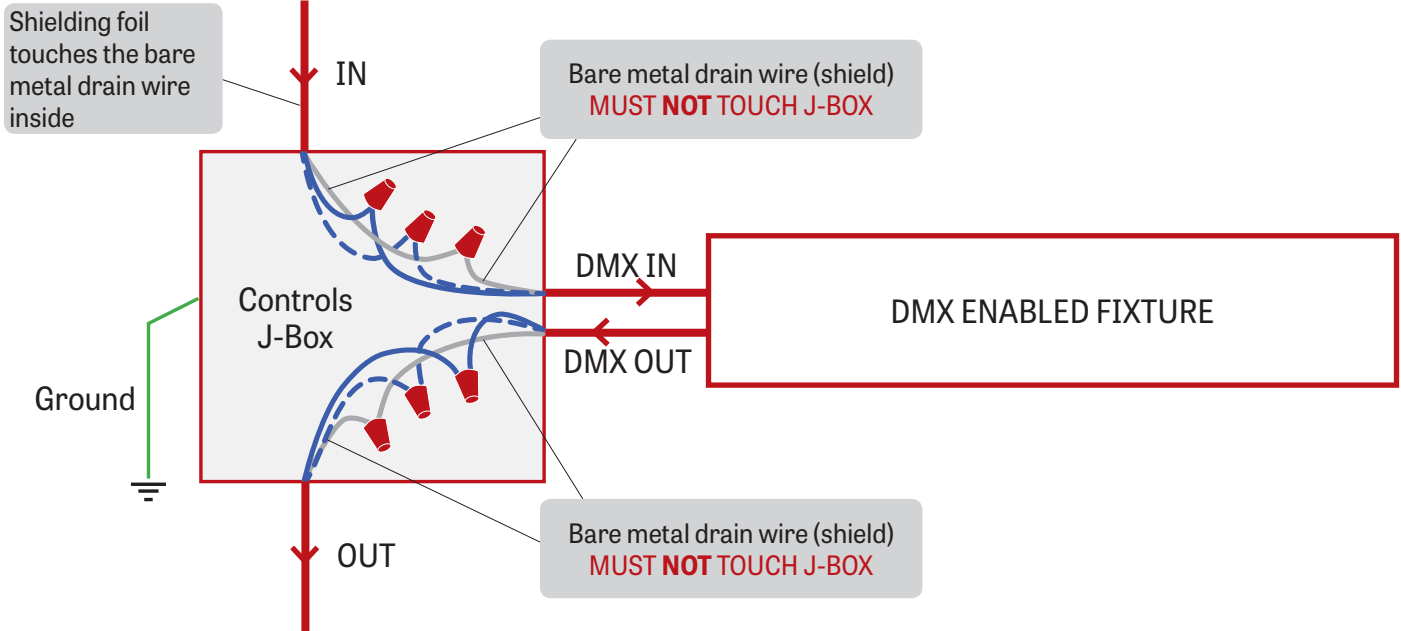

Low capacitance DMX cable to next fixture

3 DMX CONNECTION RECESSED & SURFACE

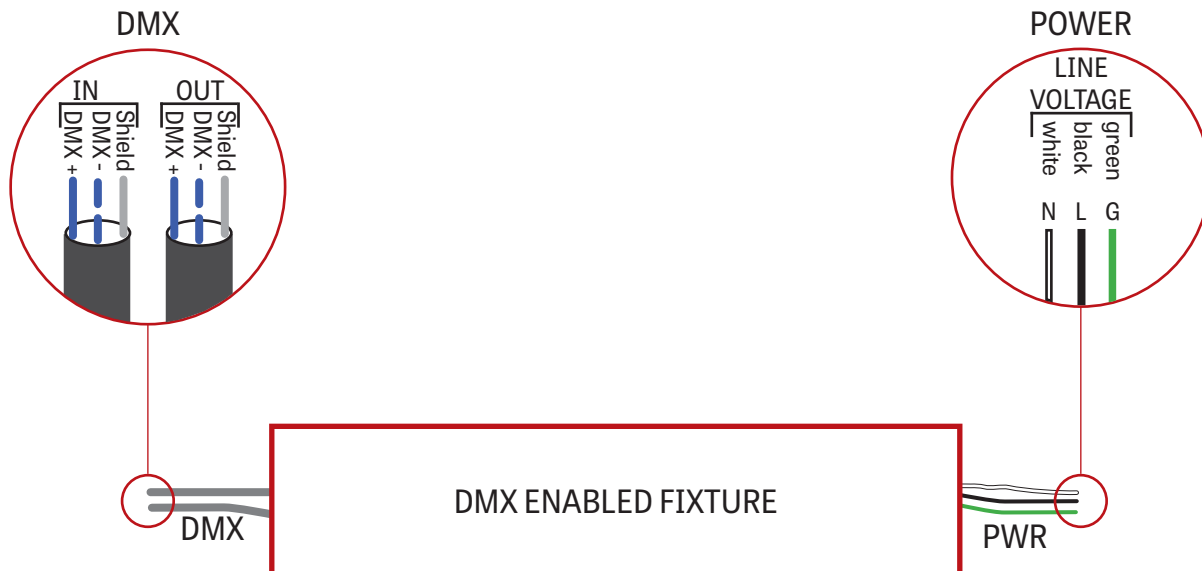

CHROMAWERX TUNABLE WHITE

4 DMX LAST FIXTURE DETAIL

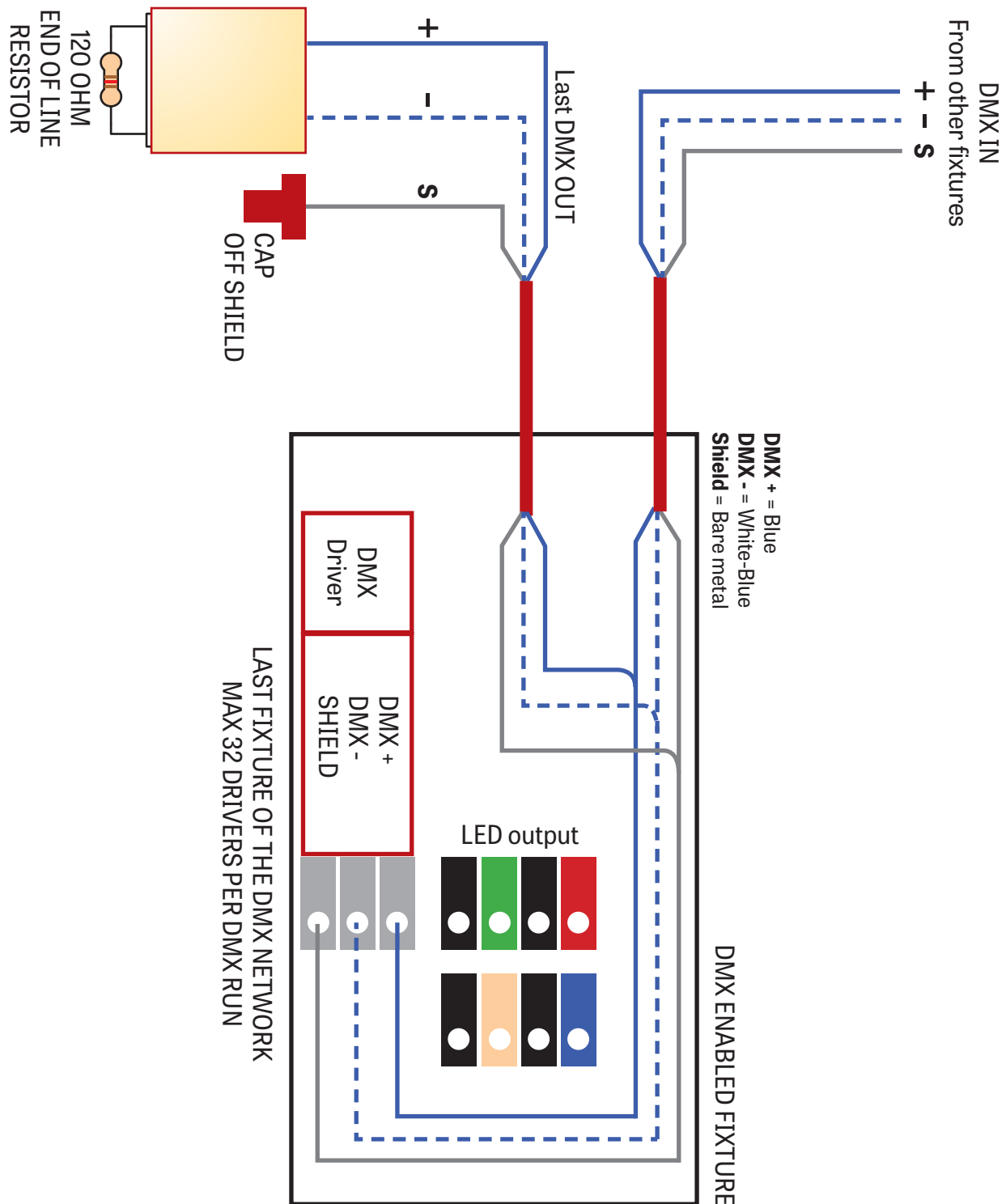

CHROMAWERX TUNABLE WHITE

DMX WALL CONTROLLER

DUO 1-4 ZONE

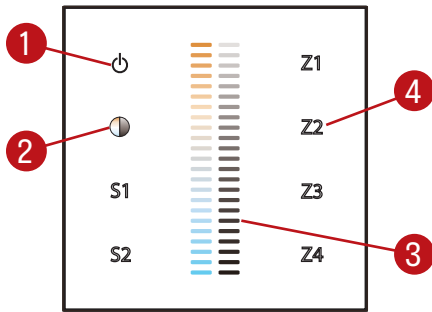

- (1) Power: Use this button to turn ON or OFF the fixture
- (2) Brightness/CCT: Use the color/brightness toggle button to chose between color/brightness. when Blue: brightness is selected, when Yellow: color is selected.
- (3) Slider: Depending on the mode chosen in 2, the slider will allow the user to set desired color or brightness.
- (4) Zone select: Up to 4 zones can be selected either independently or together. Once selected the commands will be sent to the zone identified by a Blue LED.

Default DMX Addresses:

- 1 Warm
- 2 Cool