

VIA 4 WALL

DIRECT/INDIRECT, DIRECT, INDIRECT
CHROMAWERX - SOLA, DUO

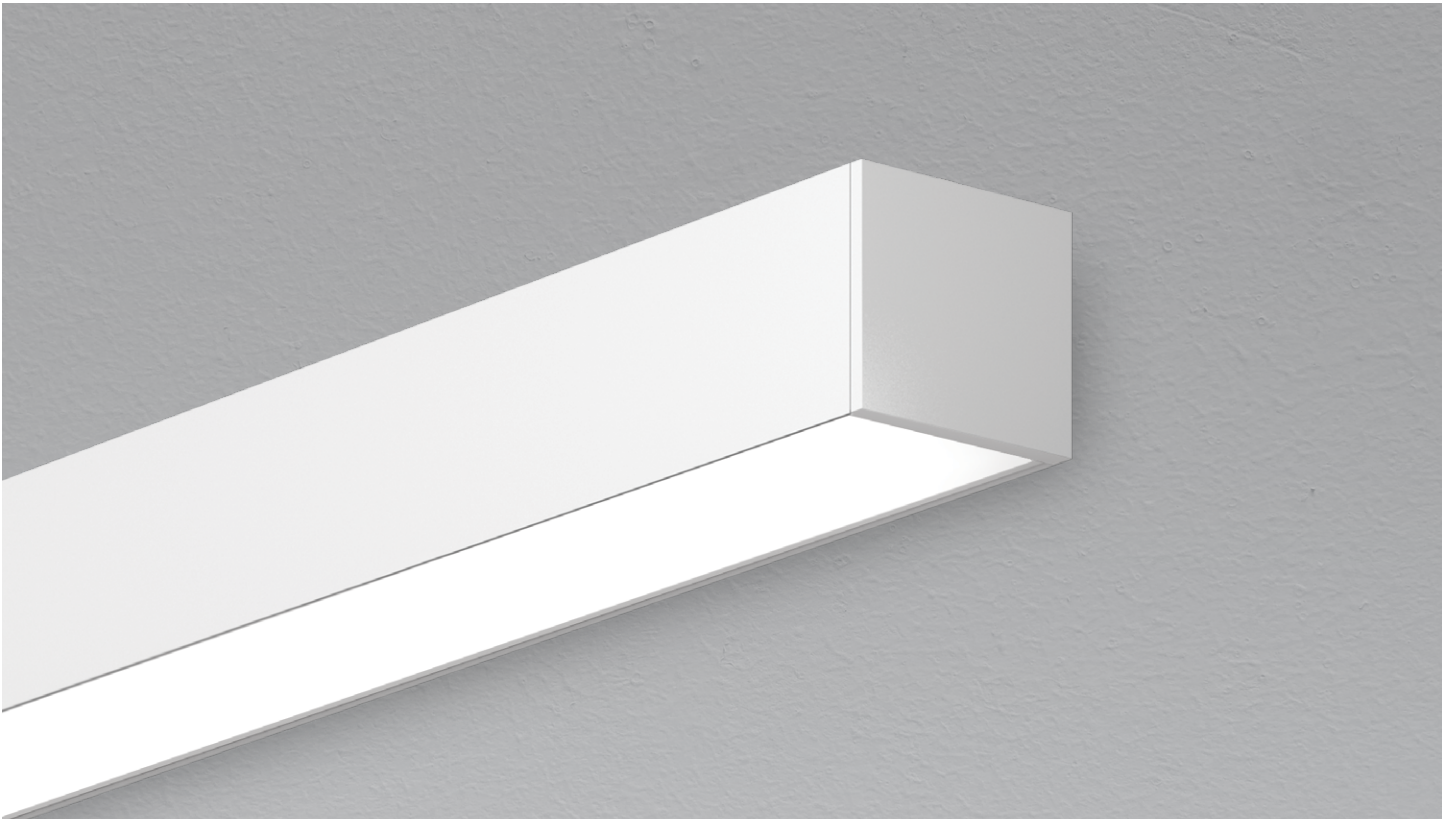

Declare.



Our elegant, flexible Via family is composed of linear, pendant, surface, recessed, and wall mounted luminaires. Each lighting fixture can be installed as a discrete luminaire or in continuous runs or patterns. Via 4 Wall is offered with Lambertian, asymmetric, or low-glare optics.

Lens Positions

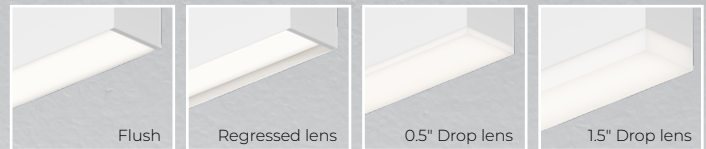

DIRECT



INDIRECT



DIRECT/INDIRECT, DIRECT, INDIRECT
CHROMAWERX - SOLA, DUO

Project: _____

Type: _____

Order Guide

LUMINAIRE ID	DISTRIBUTION	DIRECT OPTIC Specify NA for Indirect fixture	LENS POSITION Specify NA for Indirect fixture	INDIRECT OPTIC Specify NA for Direct fixture	LIGHT SOURCE ⁴
VIA4W					
VIA4W - Via 4" Wall	DI - Direct/Indirect D - Direct I - Indirect	HLO - High-Efficiency Lambertian Optic ARO2 - Asymmetric Refractive Optic LGO - Low-Glare Optic MPO - Micro-Prismatic Optic NA - Not applicable	FH ¹ - Flush RG ¹ - Regressed 0.5D ¹ - 0.5" drop 1.5D ¹ - 1.5" drop NA ¹ - Not applicable ¹ For HLO, specify FH, RG, 0.5D, or 1.5D. • For ARO2, LGO, and MPO, specify FH. • For an Indirect fixture, specify NA.	TIO ² - Translucent Indirect Optic WAI2 - Widespread Asymmetric Indirect Optic HLO ³ - High-Efficiency Lambertian Optic ARO2 ³ - Asymmetric Refractive Optic NA - Not applicable ² Available only with Direct/Indirect. ³ Not available with Direct/Indirect.	SOLA - Dim-to-warm single channel control 35K to 22K DUO - Tunable white 2-channel control 65K to 27K ⁴ Static white, BIOS, and Chromawerx QUADRO also available. Consult other spec sheets.

CRI	DIRECT LUMEN PACKAGE Specify NA for Indirect fixture	INDIRECT LUMEN PACKAGE Specify NA for Direct fixture	LUMINAIRE LENGTH	VOLTAGE
80CRI - 80+ CRI 90CRI - 90+ CRI	350LMF ⁵ - Hypo output 350 lm/ft 500LMF - Low output 500 lm/ft 750LMF - Medium output 750 lm/ft 1000LMF - High output 1000 lm/ft 1200LMF ⁶ - Ultra high output 1200 lm/ft 1500LMF ^{7,8,9} - Hyper output 1500 lm/ft NA - Not applicable ⁵ Minimum 3' fixture. ⁶ For Direct/Indirect, Indirect must not exceed 750 lm/ft. ⁷ Available with HLO only. ⁸ For Direct/Indirect, Indirect must not exceed 500 lm/ft.	350LMF ⁵ - Hypo output 350 lm/ft 500LMF - Low output 500 lm/ft 750LMF - Medium output 750 lm/ft 1000LMF - High output 1000 lm/ft 1200LMF ⁶ - Ultra high output 1200 lm/ft 1500LMF ^{7,9} - Hyper output 1500 lm/ft NA - Not applicable ⁹ Fixture will be very bright. Use in suitable applications. ¹⁰ For Direct/Indirect, Direct must not exceed 750 lm/ft.	#FT#IN ¹¹ - Specify nominal length (#) in 1' and/or 1" increments Standard nominal lengths: Single units: 2' to 12' (up to 8' for MPO) Continuous runs: lengths over 12' (8' for MPO) ¹¹ • Minimum 2' for Direct or Indirect. • Minimum 3' for Direct/Indirect. • Minimum 4' for DMX.	120V - 120V 277V - 277V UNV - 120V-277V

DRIVER ¹²	ELECTRICAL	MOUNTING	FINISH	OPTION
SOLA SD1 - Single 0-10V input DUO DMX ^{13,14} - DMX DDA ¹⁴ - DALI DT6 DDA8 ¹⁴ - DALI DT8 DD1 - Dual 0-10V input for CCT/intensity LD2 ¹⁴ - Lutron DALI-2 digital ¹² PoE (Power-over-Ethernet) compatible. Consult factory for details. ¹³ For more information, see pages 8 to 13. ¹⁴ On-site commissioning is required.	1C 1C - 1 circuit	DMB DMB - Drywall mounting bracket	W - Matte white AL - Aluminum B - Matte black CF# - Custom finish, specify RAL#	FU120 - Fuse 120V FU277 - Fuse 277V NA - None

Accessories

Optional, order separately

WALL CONTROLLER ¹⁵	
DMX WCW##FT ¹⁶ - DMX wall controller white WCB##FT ¹⁶ - DMX wall controller black	DD1 TWCW##FT ^{17,18} - Dual 0-10V wall controller white TWCB##FT ^{17,18} - Dual 0-10V wall controller black
¹⁵ Specify wire length (##) in feet. ¹⁶ Available with DMX only. For more information, see pages 8 to 13, or consult factory. ¹⁷ Available with DD1 only. For more information, see page 14, or consult factory. ¹⁸ Only available with 120V.	

VIA 4 WALL



DIRECT/INDIRECT, DIRECT, INDIRECT
CHROMAWERX - SOLA, DUO

Dimensions

Flush Lens

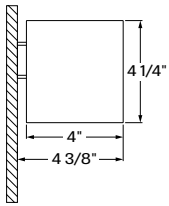

Regressed Lens¹

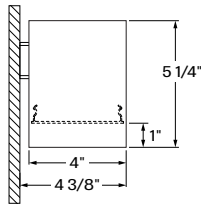

0.5" Drop Lens¹

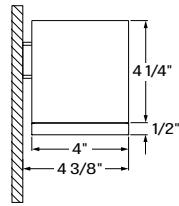

1.5" Drop Lens¹

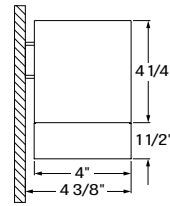

¹ Only available with HLO direct lens.

DIRECT/INDIRECT, DIRECT, INDIRECT
CHROMAWERX - SOLA, DUO

Photometrics

Values calculated based on a 4' fixture at 3500K for all optics.

DIRECT OPTICS

HLO (Flush lens)

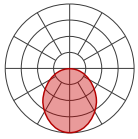

LM/FT	W/FT	LM/W
350	2.8	124
500	4.1	122
750	6.3	118
1000	8.7	115
1200	10.7	112
1500	13.8	108

ARO2

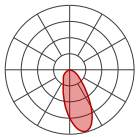

LM/FT	W/FT	LM/W
350	3.0	116
500	4.4	113
750	7.0	107
1000	9.7	103
1200	12.1	99

LGO

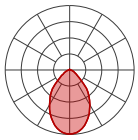

LM/FT	W/FT	LM/W
350	3.4	103
500	4.9	101
750	7.7	98
1000	10.5	95
1200	13.0	92

MPO

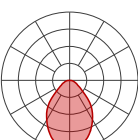

LM/FT	W/FT	LM/W
350	3.0	117
500	4.3	117
750	6.5	116
1000	8.8	113
1200	10.8	111

INDIRECT OPTICS

TIO

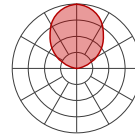

LM/FT	W/FT	LM/W
350	2.7	127
500	4.0	124
750	6.3	119
1000	8.8	114
1200	10.9	110

WAI2

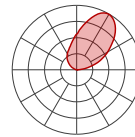

LM/FT	W/FT	LM/W
350	2.5	139
500	3.7	135
750	5.8	130
1000	8.0	125
1200	10.0	120

HLO

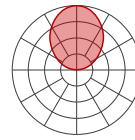

LM/FT	W/FT	LM/W
350	2.8	124
500	4.1	122
750	6.3	118
1000	8.7	115
1200	10.7	112
1500	13.8	108

ARO2

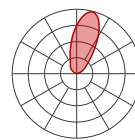

LM/FT	W/FT	LM/W
350	3.0	116
500	4.4	113
750	7.0	107
1000	9.7	103
1200	12.1	99

MULTIPLIER TABLES

Use these tables to get results for different color temperatures and lens positions for all photometric tables.

SOLA

CCT	WATTS	LPW
	80+ CRI / 90+ CRI	80+ CRI / 90+ CRI
3500K	1.00	1.00

DUO

CCT	WATTS	LPW
	80+ CRI / 90+ CRI	80+ CRI / 90+ CRI
2700K	1.05	0.95
6500K	1.00	1.00

Multiplier - Lens position

DIRECT LENS	WATTS	LPW
Flush lens	1.00	1.00
Regressed lens	0.98	1.02
Drop lens 0.5"	0.98	1.02
Drop lens 1.5"	0.96	1.05

DIRECT/INDIRECT - LPW CALCULATION

For Direct/Indirect performance values, follow the formula.

$$\frac{\left(\begin{array}{c} \text{DIRECT} \\ \text{LM/FT} \end{array} + \begin{array}{c} \text{INDIRECT} \\ \text{LM/FT} \end{array} \right)}{\left(\begin{array}{c} \text{DIRECT} \\ \text{W/FT} \end{array} + \begin{array}{c} \text{INDIRECT} \\ \text{W/FT} \end{array} \right)} = \text{LPW}$$

Technical Specifications

DIRECT OPTICS

High-Efficiency Lambertian Optic (HLO)

The High-Efficiency Lambertian Optic (HLO) uses matte white reflectors to distribute LED output across 0.075" acrylic shielding, providing up to 88% transmission and good obscuration.

Available with different lens position options, HLO has a spacing criterion of 1.16.

Asymmetric Refractive Optic (ARO2)

The Asymmetric Refractive Optic (ARO2) uses a sophisticated reflector combined with a matte beam-shaping film to create a smooth, effective downward light component without shadows or hot spots. Microstructure material applied to the snap-in lens provides the precise refractive power and visual comfort, while achieving a high luminous efficacy.

Low-Glare Optic (LGO)

The Low-Glare Optic (LGO) is designed to cut off high-angled light and control glare. The carefully crafted lens refracts light downward through its center from which it then disperses into a wide conical distribution that negates any illumination at about 40°. The LGO provides the visual comfort of a louver in a smooth acrylic lens.

Micro-Prismatic Optic (MPO)

The Micro-Prismatic Optic (MPO) delivers high-efficiency, low-glare illumination with UGR <17. Its precision-engineered lens, composed of thousands of tiny prisms, diffuses light to reduce glare, producing a ceiling plane that reads smooth from a distance while revealing subtle texture up close. The result is balanced, efficient illumination with a refined architectural presence.

INDIRECT OPTICS

Translucent Indirect Optic (TIO)

The Translucent Indirect Optic (TIO) is composed of a horizontal LED array that has a translucent lens to mask pixilation from the diodes. TIO has a 100° spread in the indirect that is ideal when the fixture is mounted farther away from the ceiling.

Widespread Asymmetric Indirect Optic (WAI2)

The Widespread Asymmetric Indirect Optic (WAI2) offers an upward grazing effect with a 45° forward throw. It softly highlights the ceiling in the up-light while distributing the required illumination of the rest of an interior space. For avoiding glare and enjoying visual comfort, WAI2 is an ideal solution.

High-Efficiency Lambertian Optic (HLO)

The High-Efficiency Lambertian Optic (HLO) uses matte white reflectors to distribute LED output across 0.075" acrylic shielding, providing up to 88% transmission and good obscuration. HLO has a spacing criterion of 1.16.

Asymmetric Refractive Optic (ARO2)

The Asymmetric Refractive Optic (ARO2) uses a sophisticated reflector combined with a matte beam-shaping film to create a smooth, effective downward light component without shadows or hot spots. Microstructure material applied to the snap-in lens provides the precise refractive power and visual comfort, while achieving a high luminous efficacy.

LIGHT SOURCE

Custom linear array of alternating color temperature mid-flux LEDs are mounted directly to the housing for optimal thermal performance. For the DUO products, a color temperature range from 6500K-2700K is achievable with color points on or below the black body curve. For the SOLA products, a color temperature range from 3500K-2200K is controlled synchronously with intensity. Color consistency between fixtures is maintained to within 3 SDCM. All LEDs have been tested in accordance with IESNA LM-80-08 and the results have shown L80 lumen maintenance greater than 60,000 hours. Absolute product photometry is measured and presented in accordance with IESNA LM-79, unless otherwise indicated.

Chromawerx SOLA

It is a single-channel control that dims output while warming the color temperature in a pre-determined relationship. A simple analog control sends a common signal to dual output digital drivers, which are programmed to adjust a specially populated LED array to emulate the effect of dimming a filament source. Dimming range is programmable but the default option runs from 3500K at 100% of full power to 2200K at 5% of full power. CRI is maintained above 80 throughout the dimming range.

Chromawerx DUO

It is a two-channel control. It uses an analog (0-10V) protocol for separate control of luminaire CCT and intensity or a digital (DMX, DALI, and LD2) protocol for synchronous control of both warm and cool LED arrays to enable the user to set color temperature and light output. Commonly called "tunable white", Chromawerx two-channel control provides the range of cool (6500K) to warm (2700K) color that can be useful for helping to entrain circadian rhythms, stimulate alertness for improved educational and work productivity, and compensate for jet lag, among other applications. The Chromawerx drivers are programmed to limit maximum light output and power usage across all color temperatures. CRI is maintained above 80. When paired with DALI drivers (DDA/DDA8), color tuning follows a linear dimming curve.

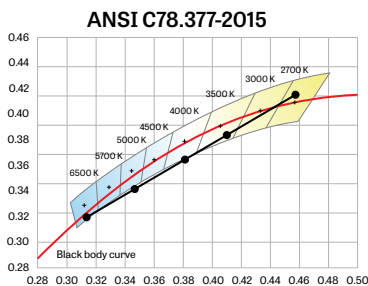

LUMINAIRE LENGTH

Via 4 is available in standard lengths of 2' to 12' (up to 8' for MPO). Continuous runs are available for run lengths over 12' (8' for MPO). Exact run length must be noted in the product code. The minimum length is 2' for Direct or Indirect fixtures, 3' for Direct/Indirect fixtures, and 4' for DMX. Lengths can be ordered in 1' and/or 1" increments. All individual sections are joined together onsite using the joiner kits provided. Lumenwerx offers joiner kits that are extremely simple to work with in the field and result in a fixture that appears virtually seamless with no light leak at any connection.

ELECTRICAL

SOLA

SD1

Factory-set, adjustable output current LED driver with universal (120-277 VAC) input. Using a single 0-10V control signal, the light output warms in color temperature as it dims down to 1% and 2200K. At maximum driver load, efficiency<86%, PF>0.9, THD<20%.

DUO

DMX

Factory-set adjustable output current electronic driver with 120-277 VAC line input. Using DMX wall controls (optionally supplied by Lumenwerx) or an existing DMX control system, both channels of LEDs are independently adjustable. Each DMX driver can be independently addressed using the built-in RDM (Remote Device Management) in the field. Dimming down to 1% is attainable. Rated life (90% survivorship) of 50,000 hours at 50°C maximum ambient temperature. At maximum driver load, efficiency<84%, PF>0.9, THD<20%.

DALI

Factory-set adjustable output current electronic driver with 120-277 VAC line input. Using an existing DALI control system (supplied by others), one control channel adjusts the fixture color temperature, and the other control channel adjusts fixture brightness. With DALI Type 6, two DALI addresses are required to control both channels. With DALI Type 8, one DALI address is required to control both channels. Dimming down to 1% is attainable. Rated life (90% survivorship) of 50,000 hours at 50°C maximum ambient temperature. At maximum driver load, efficiency<84%, PF>0.9, THD<20%.

DD1

Factory-set adjustable output current LED driver with universal (120-277 VAC) input. Controlled via two individual 0-10V signals, one for setting light output down to a minimum of 1% and the other for adjusting the CCT (default range of 6500K-2700K). Rated life of 50,000 hours at 70°C maximum driver case temperature and 100% load conditions. Typical efficiency of 86%, PF>0.9, THD<20% at 100% load conditions.

LD2

Lutron DALI-2 digital drivers provide a high-performance tunable white solution with single-address digital control. Guaranteed performance and compatibility when used with Lutron DALI-2 controls.

PoE

Depending on the PoE manufacturer selected, Lumenwerx will install the node in factory as either integral to the luminaire or as a remote module. Factory programming of the PoE node may or may not enable the following functionalities: lumen package, DUO (tunable white), QUADRO (RGBW), emergency battery backup, and sensor integration. These must be addressed and evaluated on a case-by-case basis.

MOUNTING

Fixtures may be horizontally mounted to the wall using a bracket. For long runs, a minimum of 6" from adjacent wall is required.

VIA 4 WALL



DIRECT/INDIRECT, DIRECT, INDIRECT
CHROMAWERX - SOLA, DUO

FINISH

Interior: 95% reflective matte powder coated white paint
Exterior: Matte white, matte black or aluminum powder coating.
Custom finishes are also available.

CONSTRUCTION

Housing: Extruded aluminum
Interior brackets: Die-formed cold rolled sheet steel
Joining system: Die-cast zinc
Reflectors: Die-formed cold rolled steel, 95% reflective matte white painted
Lens: Acrylic
Drop lens: Extruded with glued end caps
End caps: Die-cast aluminum

WEIGHT

Direct/Indirect	Direct or Indirect
4': 13.66 lbs - 6.2 kg	4': 11.45 lbs - 5.2 kg
8': 27.53 lbs - 12.5 kg	8': 23.13 lbs - 10.5 kg
12': 41.41 lbs - 18.8 kg	12': 34.58 lbs - 15.7 kg

CERTIFICATIONS

ETL: Rated for indoor dry/damp locations. Conforms to UL Standard 1598 and certified to CAN/CSA Standard C22.2 No. 250.0.
Declare: [LBC Red List Approved](#)

WARRANTY

Lumenwerx provides a five-year limited warranty on electrical and mechanical performance of the luminaires, including the LED boards, drivers, and auxiliary electronics. Lumenwerx will repair or replace defective luminaires or components at our discretion, provided they have been installed and operated in accordance with our specifications. Other limitations apply, please refer to the full warranty on our website.
Wall controllers are covered by the manufacturer warranty.

DUO DMX SPECIFICATION

A qualified DMX integrator is required to assure proper installation and commissioning of the DMX network. **When placing the PO, please provide the contact information of your DMX integrator.**

Please answer the following questions to help us identify your DMX network requirements.

YES

Do you require a wall controller provided by Lumenwerx?

NO

DMX control system supplied by others. Lumenwerx will supply DMX-enabled fixtures with default DMX addressing. See following pages for technical DMX informations. ✓

DMX controller supplied by Lumenwerx

How many zones do you have?

A zone consists of one or more luminaires behaving identically.

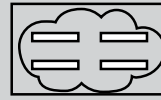

1 Zone



2 Zones

How to calculate the required number of drivers:

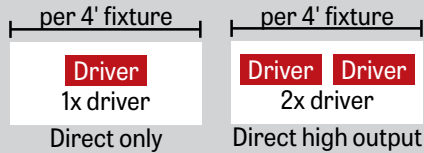

To Calculate # of drivers

1 - 4 Zones

5 or more Zones

Do you have more than 32 drivers in total?

NO

YES

Order a standard Lumenwerx wall controller.

WALL CONTROLLER

WCW - wall controller white
WCB - wall controller black

Add the control code at the end of your order code. Please provide a fixture layout or RCP (Reflected Ceiling Plan) showing the locations of the DMX fixtures, zones and the DMX wall controller. Refer to your DMX integrator for the installation. ✓

Subject to factory evaluation. Please contact our controls specialist at controls@lumenwerx.com. Additional cost and equipment will be required. ✓

Subject to factory evaluation and approval. Please contact our controls specialist at controls@lumenwerx.com. Additional cost and equipment will be required. ✓

GENERIC DMX NETWORK ARCHITECTURE

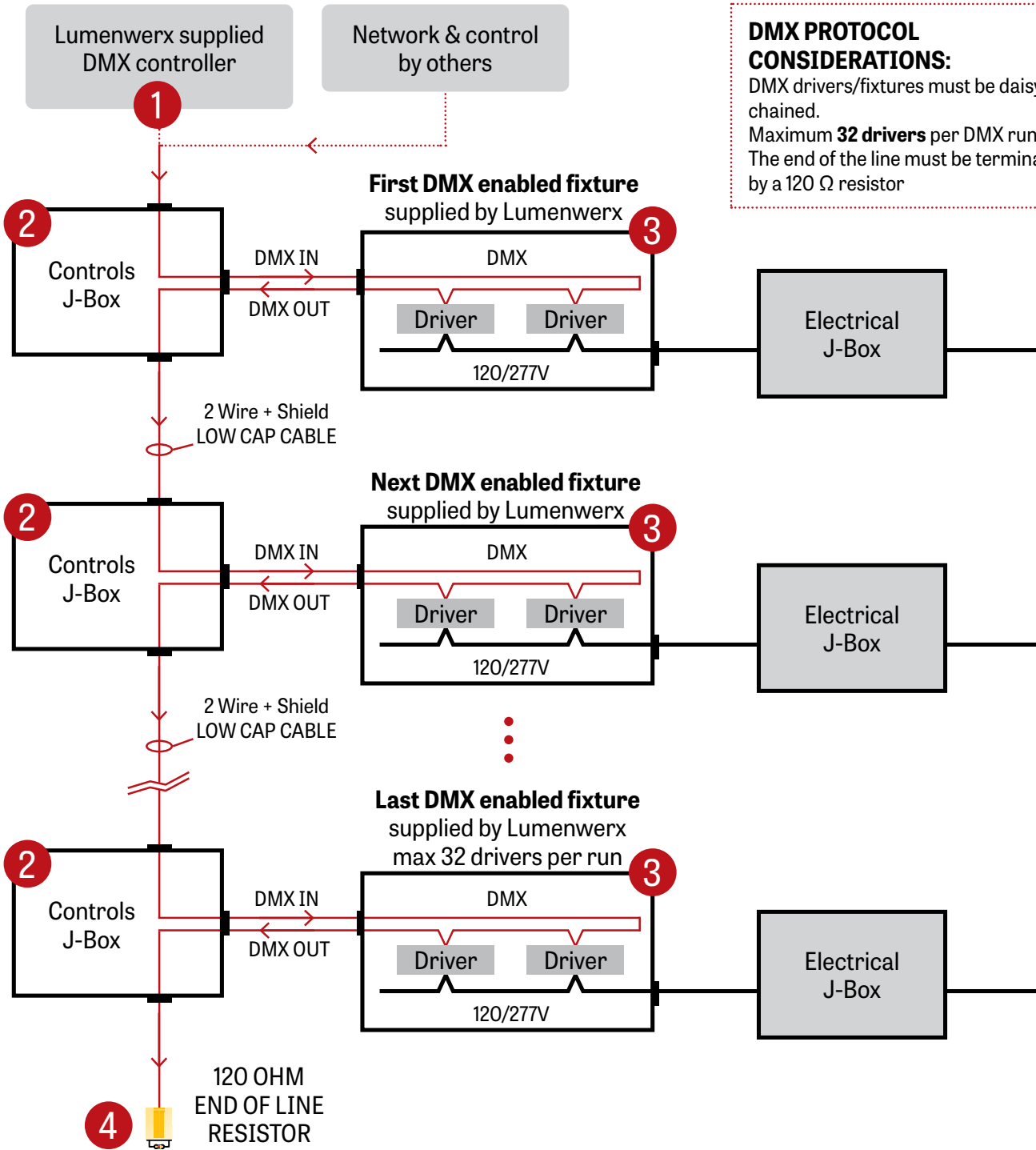

DMX PROTOCOL CONSIDERATIONS:
DMX drivers/fixtures must be daisy chained.
Maximum **32 drivers** per DMX run.
The end of the line must be terminated by a 120 Ω resistor

VIA 4 WALL

DIRECT/INDIRECT, DIRECT, INDIRECT
CHROMAWERX - SOLA, DUO



1 LUMENWERX SUPPLIED DMX CONTROLLER

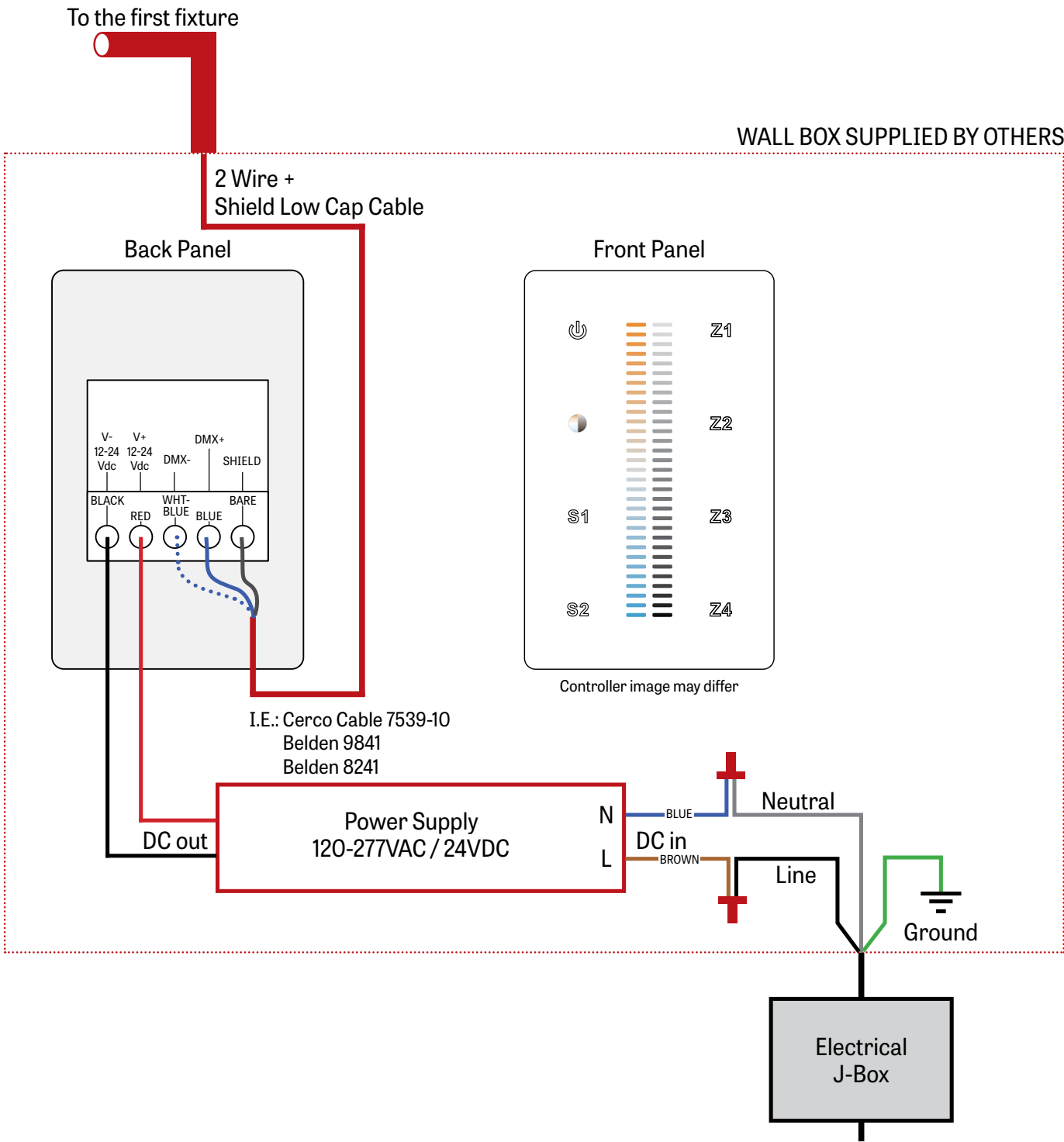

2 J-BOX DMX DAISY CHAIN DETAIL

Low capacitance DMX Cable from Previous Fixture

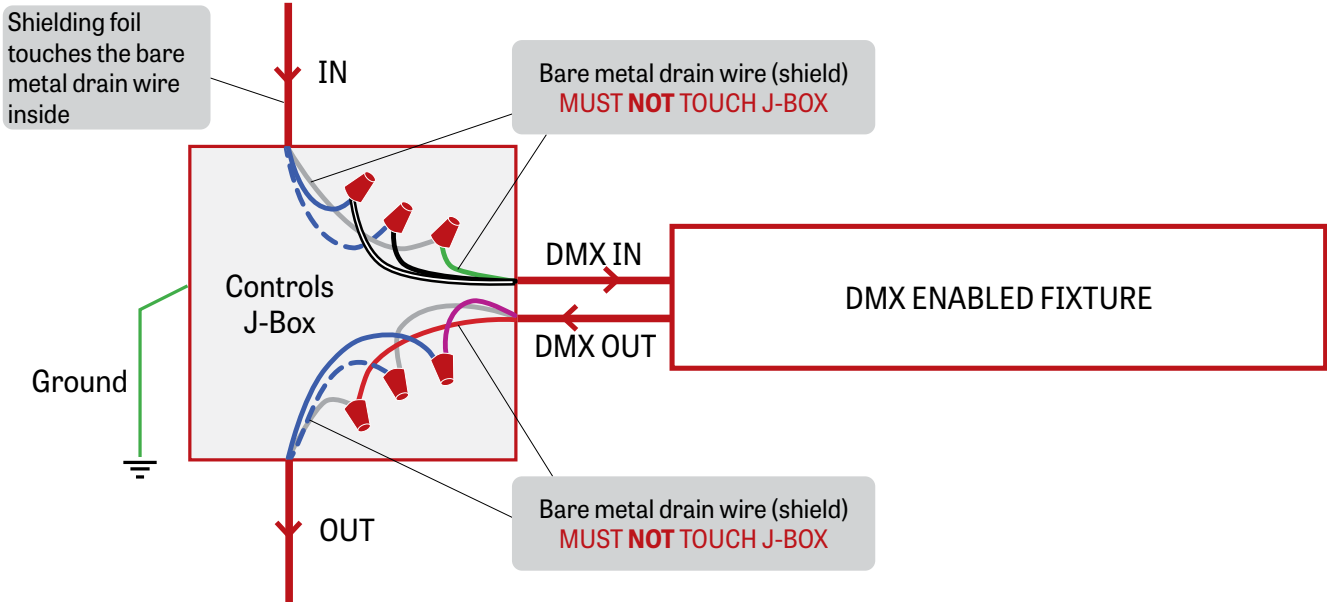

Low capacitance DMX cable to next fixture

3 DMX CONNECTION PENDANT & WALL

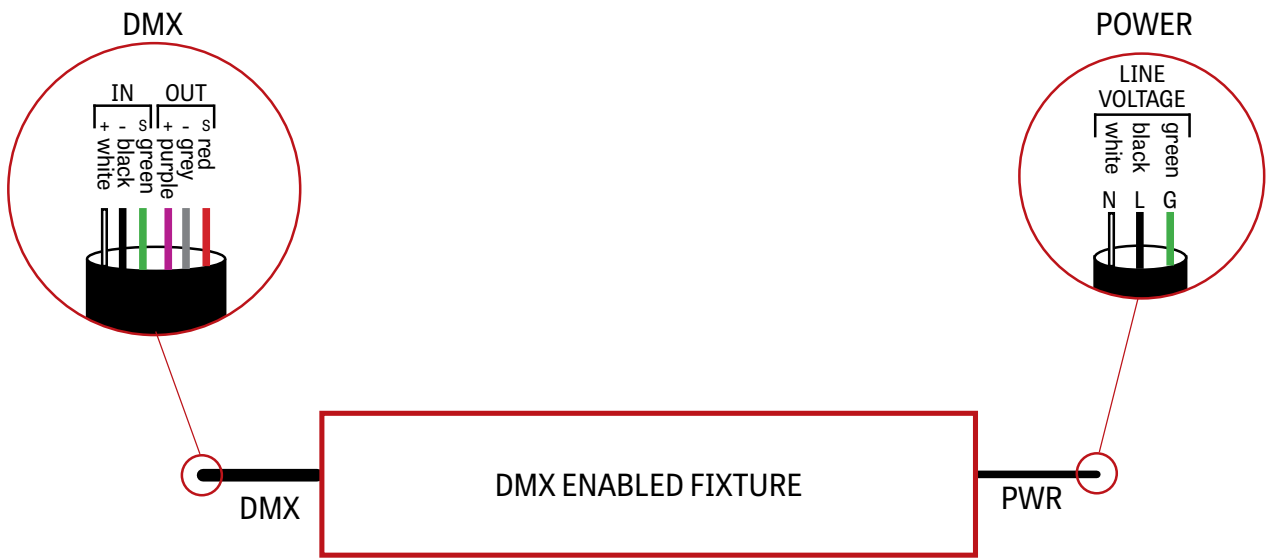

VIA 4 WALL

DIRECT/INDIRECT, DIRECT, INDIRECT
CHROMAWERX - SOLA, DUO



4 DMX LAST FIXTURE DETAIL

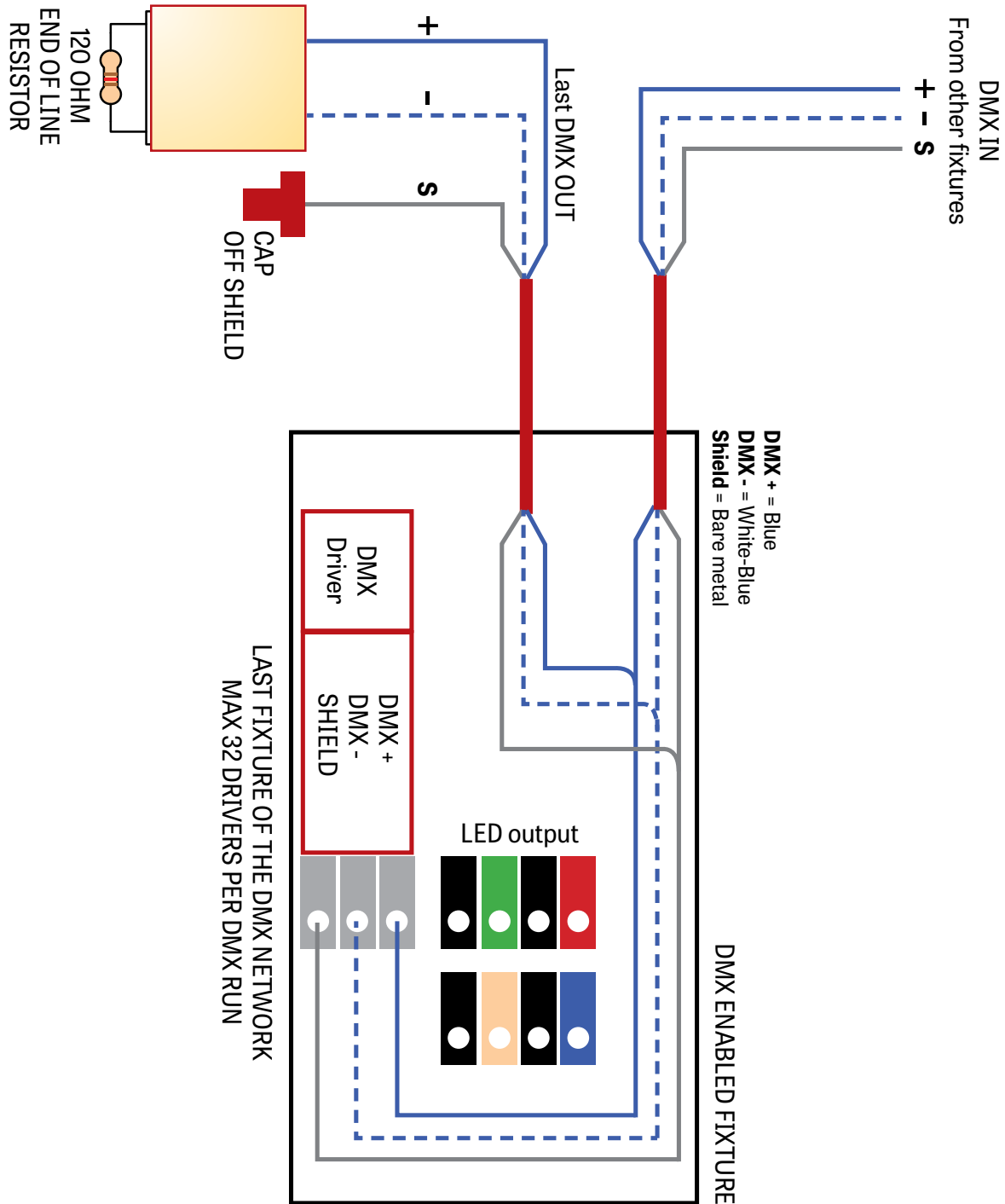

VIA 4 WALL

DIRECT/INDIRECT, DIRECT, INDIRECT
CHROMAWERX - SOLA, DUO

DMX WALL CONTROLLER

DUO 1-4 ZONE

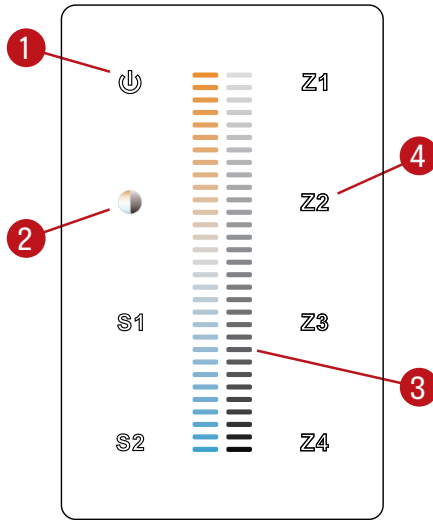

- (1) Power: Use this button to turn ON or OFF the fixture.
- (2) Brightness/CCT: Use the color/brightness toggle button to choose between color/brightness. When Blue: brightness is selected, when Yellow: color is selected.
- (3) Slider: Depending on the mode chosen in step 2, the slider will allow the user to set desired color or brightness.
- (4) Zone select: Up to 4 zones can be selected either independently or together. Once selected, the commands will be sent to the zone identified by a Blue LED.

Default DMX Addresses:

- 1 Warm
- 2 Cool

VIA 4 WALL

DIRECT/INDIRECT, DIRECT, INDIRECT
CHROMAWERX - SOLA, DUO

DUAL 0-10V WALL CONTROLLER

Front Panel

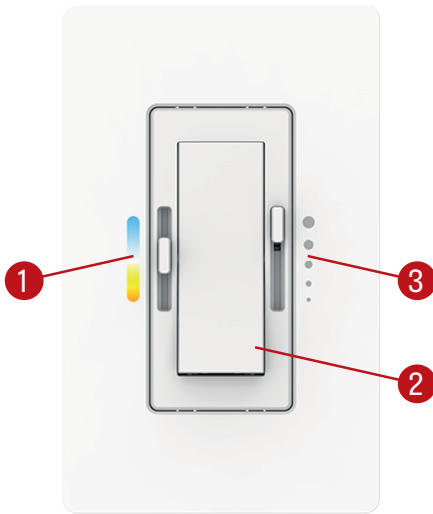

Controller image may differ

Dimensions

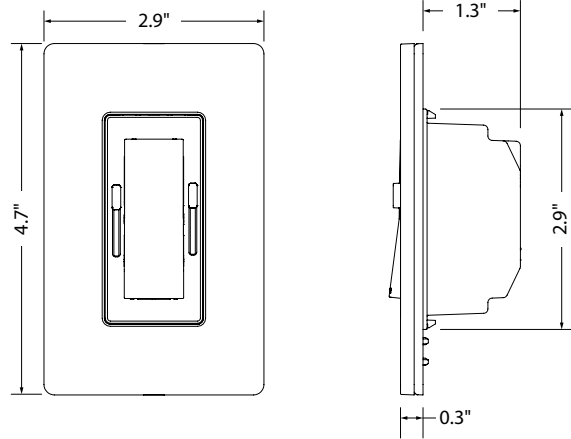

- (1) CCT control: Use this button to adjust the color temperature.
- (2) On/Off switch: Use this button to turn ON or OFF the fixture.
- (3) Dimming control: Use this button to adjust the brightness.

Wiring Diagram

