

VIA 4 SEAL

SURFACE PATTERN

DIRECT

CHROMAWERX - SOLA, DUO

VIA WEATHER SERIES



Project: _____

Type: _____

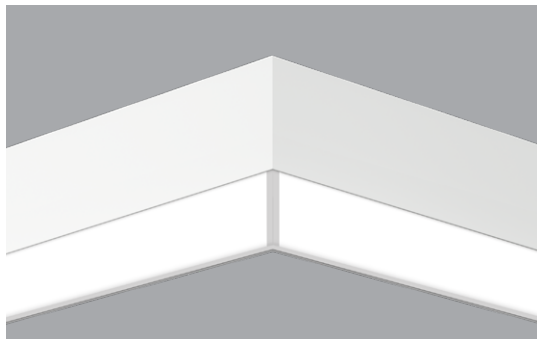

LEV - Leveled corner

DESCRIPTION

Sealed with silicone gaskets, Via Seal fixtures are intended for wet locations and can be pendant, surface, wall, or recessed mounted. They can act alone as discrete luminaires, or be arranged in continuous lines or patterns. Via 4 Seal is suitable for wet locations where temperatures are moderate and in which spaces are regularly wiped down and frequently in contact with debris and/or moisture. The fixture can be used to create continuous, unbroken lines of light. Via 4 Seal is also offered as Wet Listed certified by ETL (Electrical Testing Laboratories), in which case, it is able to withstand smaller particles of debris and light water infiltration. Via 4 Seal Wet Listed can also be used to create continuous lines of light, but with subtle breaks at 12' increments. See separate spec sheets for other available mountings.

IMPORTANT:
Fixture must be installed with lens facing down.

IK05



Order Guide

LUMINAIRE ID	DISTRIBUTION	ENVIRONMENT ¹	OPTIC	LIGHT SOURCE ⁴	CRI
V4SEALSPAT	D				
V4SEALSPAT - Via 4" Seal Surface Pattern	D - Direct	WET ² - Wet Suitable (IP44) WETL ^{2,3} - Wet Listed (IP54) ¹ See page 3 for more information on each environment option. ² Suitable for outdoor environments only when installed under canopy. Not suitable for extreme weather environments. Consult factory for low temperature applications. ³ Can be slightly exposed to water. A minimal shadow line visible at every 12'.	EPDO - Environmentally Protected Direct Optic ASDO - Asymmetric Soft Direct Optic	SOLA - Dim-to-warm single channel control 35K to 22K DUO - Tunable white 2-channel control 65K to 27K ⁴ Static white and BIOS also available. Consult other spec sheet.	80CRI - 80 CRI 90CRI - 90 CRI

LUMEN PACKAGE	PATTERN LENGTH	CORNER TYPE	VOLTAGE	DRIVER ⁶	ELECTRICAL
					1C
500LMF - Low output 500 lm/ft 750LMF - Medium output 750 lm/ft 1000LMF - High output 1000 lm/ft	##FT##IN(##FT##IN-##FT##IN-...) ⁵ - ##FT##IN: total nominal length of pattern in feet and/or inches #X: quantity of each section #FT##IN: nominal length of each section in feet and/or inches Continuous runs: lengths over 12' ⁵ Minimum 2'.	#LEV2C(A90) - 2-way leveled corner	ANGLE (A##): (A90) - 90° 120V - 120V 277V - 277V UNV - 120V-277V	SOLA SD1 - Single 0-10V input DUO DMX ^{7,8} - DMX DDA ⁸ - DALI DT6 DDA8 ⁸ - DALI DT8 DD1 - Dual 0-10V input for CCT/intensity LD2 ⁸ - Lutron DALI-2 digital ⁶ PoE (Power-over-Ethernet) compatible. Consult factory for details. ⁷ For more information, see pages 8 to 13. ⁸ On-site commissioning is required.	1C - 1 circuit

POWER FEED	MOUNTING	FINISH	OPTION
	GSM		
TF - Top feed EF - End feed	GSM - Gasketed surface mount	W - Matte white AL - Aluminum B - Matte black WA - White antimicrobial Silverwerx CF# - Custom finish, specify RAL#	CRF - Corrosion-resistant finish NA - None

Accessories

Optional, order separately

WALL CONTROLLER	
DMX WCW ⁹ - DMX wall controller white WCB ⁹ - DMX wall controller black ⁹ Available with DMX only. For more information, see pages 8 to 13, or consult factory.	DD1 TWCW ¹⁰ - Dual 0-10V wall controller white TWCB ¹⁰ - Dual 0-10V wall controller black ¹⁰ Available with DD1 only. For more information, see page 14, or consult factory.



VIA 4 SEAL

SURFACE PATTERN

DIRECT

CHROMAWERX - SOLA, DUO

VIA WEATHER SERIES



Pattern Layout

CORNER TYPE

LEVELED CORNER

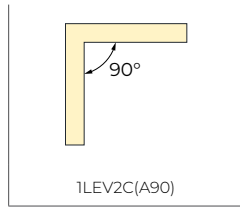

EXAMPLES

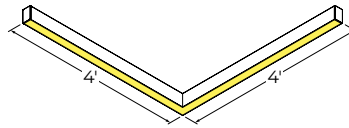

8FT(2X4FT)-1LEV2C(A90)

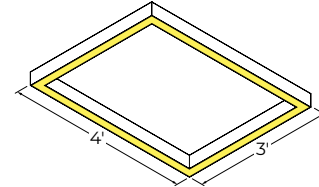

14FT(2X4FT-2X3FT)-4LEV2C(A90)

Dimensions

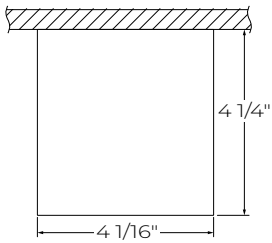

VIA 4 SEAL

SURFACE PATTERN

DIRECT

CHROMAWERX - SOLA, DUO





VIA WEATHER SERIES

Environment Options

The Via Weather Series offers four levels of protective sealing: Level 1, Level 2, Level 3, and Level 4.

Via 4 Seal is available with two environment options: Wet Suitable (WET) at Level 1, and Wet Listed (WETL) at Level 2.

For other levels of protective sealing, please see Via Wet spec sheets for Level 3, and Via Splash spec sheets for Level 4.

FEATURES	 Wet Suitable (IP44) (WET)	 Wet Listed (IP54) (WETL)
Indoor application that requires wipe down	●	●
Healthcare application	●	●
Outdoor application with restrictions: under canopy only	●	●
Outdoor application with restrictions: under canopy, slightly exposed	X	●
Continuous line of light over 12'	●	X
Water and dust resistant	●	●
Water and dust protected	X	●
Not suitable for extreme weather applications	●	●
Damp listed	●	X
Wet listed	X	●

VIA 4 SEAL

SURFACE PATTERN

DIRECT

CHROMAWERX - SOLA, DUO

VIA WEATHER SERIES



Photometrics

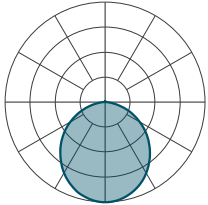

EPDO - Delivered Lumens at 4000K at 80 CRI

LUMENS PER FOOT	TOTAL LUMENS PER 4FT	INPUT WATTS	LPW
500	2000	19.8	101
750	3000	30.7	98
1000	4000	42.3	95

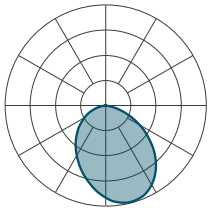

ASDO - Delivered Lumens at 4000K at 80 CRI

LUMENS PER FOOT	TOTAL LUMENS PER 4FT	INPUT WATTS	LPW
500	2000	17.7	113
750	3000	27.9	107
1000	4000	39	103

VIA 4 SEAL

SURFACE PATTERN

DIRECT

CHROMAWERX - SOLA, DUO

VIA WEATHER SERIES



Technical Specifications

OPTICS

Environmentally Protected Direct Optic (EPDO)

The Environmentally Protected Direct Optic creates a seal that blocks debris and moisture, and withstands UV distortion and moderate impact. This extruded snap-in lens has a gasket to ensure proper sealing. The lens is 1/16" thick and made of frosted polycarbonate. Internally, white, side kicking reflectors guide the light through the lens. The EPDO suits moderate climate environments.

Asymmetric Soft Direct Optic (ASDO)

The Asymmetric Soft Direct Optic creates a seal that blocks debris and moisture, and withstands UV distortion and moderate impact. This extruded snap-in lens has a gasket to ensure proper sealing. The lens is 1/16" thick and made of frosted polycarbonate. Internally, white, side kicking reflectors specifically angled to guide the light through the lens to create a nice asymmetric distribution. The ASDO suits moderate climate environments.

LIGHT SOURCE

Custom linear array of alternating color temperature mid-flux LEDs are mounted directly to the housing for optimal thermal performance. For the DUO products, a color temperature range from 6500K-2700K is achievable with color points on or below the black body curve. For the SOLA products, a color temperature range from 3500K-2200K is controlled synchronously with intensity. Color consistency between fixtures is maintained to within 3 SDCM. All LEDs have been tested in accordance with IESNA LM-80-08 and the results have shown L80 lumen maintenance greater than 60,000 hours. Absolute product photometry is measured and presented in accordance with IESNA LM-79, unless otherwise indicated.

Chromawerx SOLA

It is a single-channel control that dims output while warming the color temperature in a pre-determined relationship. A simple analog control sends a common signal to dual output digital drivers, which are programmed to adjust a specially populated LED array to emulate the effect of dimming a filament source. Dimming range is programmable but the default option runs from 3500K at 100% of full power to 2200K at 5% of full power. CRI is maintained above 80 throughout the dimming range.

Chromawerx DUO

It is a two-channel control. It uses an analog (0-10V) protocol for separate control of luminaire CCT and intensity or a digital (DMX, DALI, and LD2) protocol for synchronous control of both warm and cool LED arrays to enable the user to set color temperature and light output. Commonly called "tunable white", Chromawerx two-channel control provides the range of cool (6500K) to warm (2700K) color that can be useful for helping to entrain circadian rhythms, stimulate alertness for improved educational and work productivity, and compensate for jet lag, among other applications. The Chromawerx drivers are programmed to limit maximum light output and power usage across all color temperatures. CRI is maintained above 80. When paired with DALI drivers (DDA/DDA8), color tuning follows a linear dimming curve.

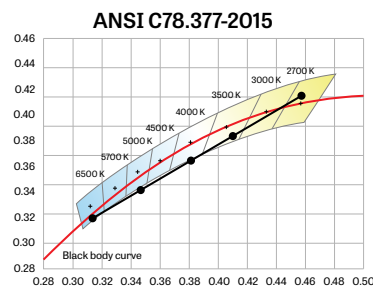

WELL BUILDING STANDARD



WELL for Light: The WELL building standard focuses on light quality in several features. There are three categories that are fully attributed to the construction and features of a luminaire. In WELL V1, it's Feature 54 Circadian Lighting, Feature 55 Glare Control, and Feature 58 Color Quality. In WELL V2, it's Feature L03 Circadian Lighting, Feature L04 Glare Control, and Feature L07 Electric Light Quality.

This fixture meets Features:

- Feature 54 or L03 when DUO is selected
- Feature 55 or L04 meets WELL glare category (c-d) (not applicable with 1000 lm/ft)
- Feature 58 or L07 when 90 CRI is selected

All LED drivers used at Lumenwerx are deemed to have a low risk level of flicker, of 5 % or less below 90Hz operational as defined by IEEE standard 1789-2015 LED.

VIA 4 SEAL

SURFACE PATTERN

DIRECT

CHROMAWERX - SOLA, DUO

VIA WEATHER SERIES



WELL for Mind: This luminaire meets WELL for mind as it is a human centric luminaire offering quality light, excellent color, and smooth optics. If any of these features are incorporated in a luminaire, it can improve the ability to focus, concentrate, and persist longer on a given task. This fixture harmoniously operates in a space to assist the mind.

For more information, please contact well@lumenwerx.com

PATTERN LENGTH

Via 4 Seal can be ordered in 1' and/or 1" increments. Continuous runs are available for run lengths over 12'. The minimum length is 2'. All individual sections are joined together onsite using the joiner kits provided. Lumenwerx joiner kits are extremely simple to work with in the field and result in a fixture that appears virtually seamless with no light leak at any connection.

JOINING SYSTEM

All individual sections are joined together onsite using the ¼"-20 screws and nuts provided. With the Wet Suitable (WET) option, the junction between two adjacent sections creates a continuous line of light without shadows. With the Wet Listed (WETL) option, the junction between two adjacent sections is sealed with a silicone gasket, creating a slight visible break in the line of light every 12'.

Wet Suitable - WET

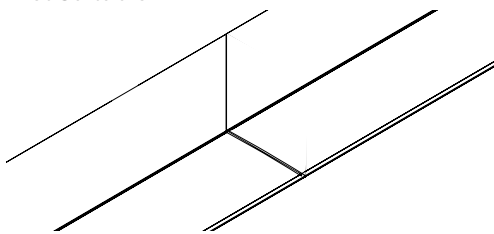

Continuous line of light

Wet Listed - WETL

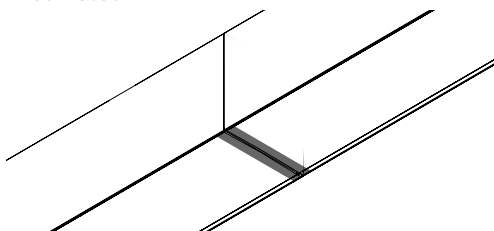

Visible break in line of light

ELECTRICAL

SOLA

SD1

Factory-set, adjustable output current LED driver with universal (120-277 VAC) input. Using a single 0-10V control signal, the light output warms in color temperature as it dims down to 1% and 2200K. At maximum driver load, efficiency<86%, PF>0.9, THD<20%.

DUO

DMX

Factory-set adjustable output current electronic driver with 120-277 VAC line input. Using DMX wall controls (optionally supplied by Lumenwerx) or an existing DMX control system, both channels of LEDs are independently adjustable. Each DMX driver can be independently addressed using the built-in RDM (Remote Device Management) in the field. Dimming down to 1% is attainable. Rated life (90% survivorship) of 50,000 hours at 50°C maximum ambient temperature. At maximum driver load, efficiency<84%, PF>0.9, THD<20%.

DALI

Factory-set adjustable output current electronic driver with 120-277 VAC line input. Using an existing DALI control system (supplied by others), one control channel adjusts the fixture color temperature, and the other control channel adjusts fixture brightness. With DALI Type 6, two DALI addresses are required to control both channels. With DALI Type 8, one DALI address is required to control both channels. Dimming down to 1% is attainable. Rated life (90% survivorship) of 50,000 hours at 50°C maximum ambient temperature. At maximum driver load, efficiency<84%, PF>0.9, THD<20%.

DD1

Factory-set adjustable output current LED driver with universal (120-277 VAC) input. Controlled via two individual 0-10V signals, one for setting light output down to a minimum of 1% and the other for adjusting the CCT (default range of 6500K-2700K). Rated life of 50,000 hours at 70°C maximum driver case temperature and 100% load conditions. Typical efficiency of 86%, PF>0.9, THD<20% at 100% load conditions.

LD2

Lutron DALI-2 digital drivers provide a high-performance tunable white solution with single-address digital control. Guaranteed performance and compatibility when used with Lutron DALI-2 controls.

VIA 4 SEAL

SURFACE PATTERN

DIRECT

CHROMAWERX - SOLA, DUO

VIA WEATHER SERIES



PoE

Depending on the PoE manufacturer selected, Lumenwerx will install the node in factory as either integral to the luminaire or as a remote module. Factory programming of the PoE node may or may not enable the following functionalities: lumen package, DUO (tunable white), QUADRO (RGBW), emergency battery backup, and sensor integration. These must be addressed and evaluated on a case-by-case basis.

MOUNTING

Fixtures can be mounted directly to hard surface ceilings only. Hardware supplied by others. Long runs require a minimum of 6" from the vertical wall.

FINISH

Interior: 95%, reflective matte powder coated white paint

Exterior: Powder-coat paint in matte white, matte black, or aluminum. Custom finishes are also available. Optional antimicrobial finish.

CONSTRUCTION

Housing: Extruded aluminum, up to 90% recycled content

Interior brackets: Die-formed cold rolled sheet steel

Joining system (WETL): Steel joiners with closed-cell silicone foam joiner gasket

Reflectors: Die-formed cold rolled sheet steel, 95% reflective matte white painted

End cap: Die-cast aluminum

End cap gasket: 1/16" closed-cell silicone foam

Mounting: Sealing washer for 1/4" threaded rods

CERTIFICATIONS

ETL: WET environment option is rated for dry/damp locations. WETL environment option is ETL Wet Listed. Conforms to UL Standard 1598 and certified to CAN/CSA Standard C22.2 No. 250.0. During the installation of WETL fixtures, the contractor is responsible for properly sealing all mounting and electrical connection points.

IK05: Impact resistance rated to IK05

WARRANTY

Lumenwerx provides a five-year limited warranty on electrical and mechanical performance of the luminaires, including the LED boards, drivers, and auxiliary electronics. Lumenwerx will repair or replace defective luminaires or components at our discretion, provided they have been installed and operated in accordance with our specifications. Other limitations apply, please refer to the full warranty on our website.

Wall controllers are covered by the manufacturer warranty.

VIA 4 SEAL

SURFACE PATTERN

DIRECT

CHROMAWERX - SOLA, DUO

VIA WEATHER SERIES



DUO DMX SPECIFICATION

A qualified DMX integrator is required to assure proper installation and commissioning of the DMX network. **When placing the PO, please provide the contact information of your DMX integrator.**

Please answer the following questions to help us identify your DMX network requirements.

YES

Do you require a wall controller provided by Lumenwerx?

NO

DMX control system supplied by others. Lumenwerx will supply DMX-enabled fixtures with default DMX addressing. See following pages for technical DMX informations. ✓

DMX controller supplied by Lumenwerx

How many zones do you have?

A zone consists of one or more luminaires behaving identically.



1 Zone



2 Zones

How to calculate the required number of drivers:

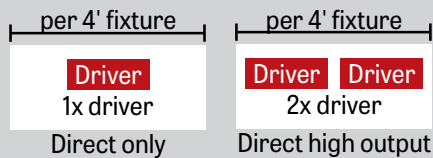

To Calculate # of drivers

1 - 4 Zones

5 or more Zones

Do you have more than 32 drivers in total?

NO

YES

Order a standard Lumenwerx wall controller.

WALL CONTROLLER

WCW - wall controller white
WCB - wall controller black

Add the control code at the end of your order code.

Please provide a fixture layout or RCP (Reflected Ceiling Plan) showing the locations of the DMX fixtures, zones and the DMX wall controller.

Refer to your DMX integrator for the installation. ✓

Subject to factory evaluation. Please contact our controls specialist at controls@lumenwerx.com. Additional cost and equipment will be required. ✓

Subject to factory evaluation and approval. Please contact our controls specialist at controls@lumenwerx.com. Additional cost and equipment will be required. ✓

VIA 4 SEAL

SURFACE PATTERN

DIRECT

CHROMAWERX - SOLA, DUO

VIA WEATHER SERIES



GENERIC DMX NETWORK ARCHITECTURE

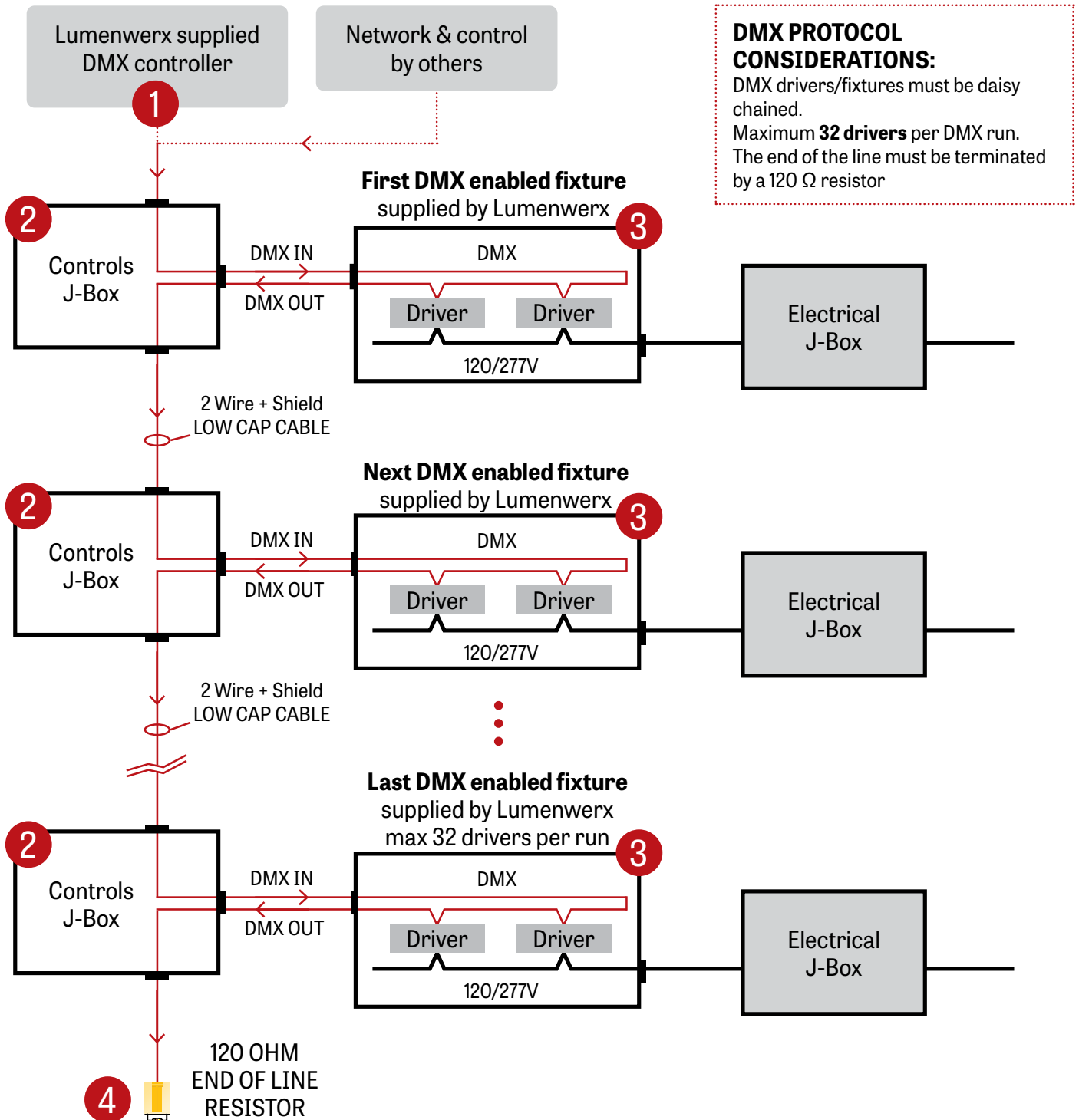

VIA 4 SEAL

SURFACE PATTERN

DIRECT

CHROMAWERX - SOLA, DUO

VIA WEATHER SERIES



1 LUMENWERX SUPPLIED DMX CONTROLLER

To the first fixture

WALL BOX SUPPLIED BY OTHERS

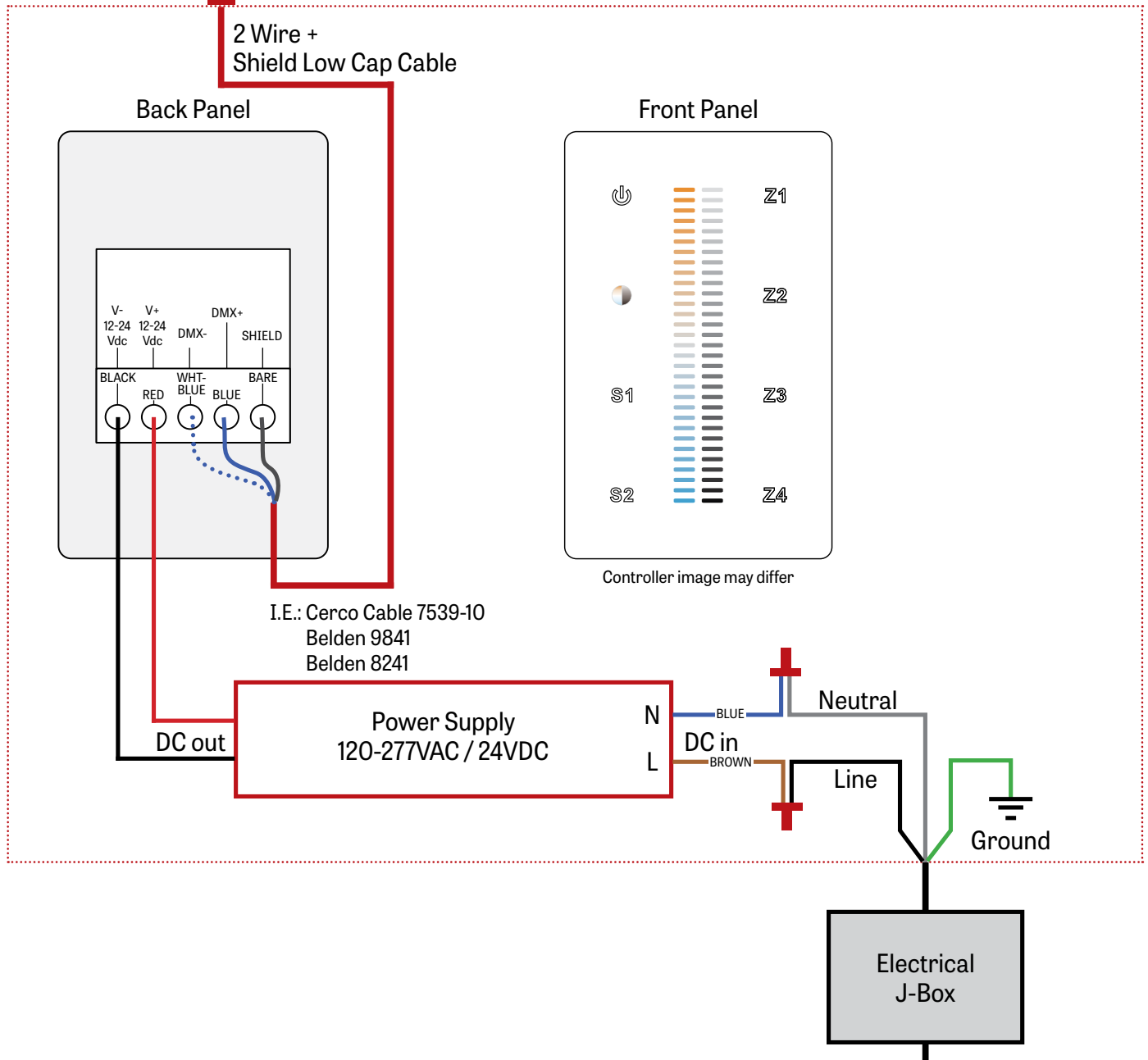

VIA 4 SEAL

SURFACE PATTERN

DIRECT

CHROMAWERX - SOLA, DUO

VIA WEATHER SERIES



2 J-BOX DMX DAISY CHAIN DETAIL

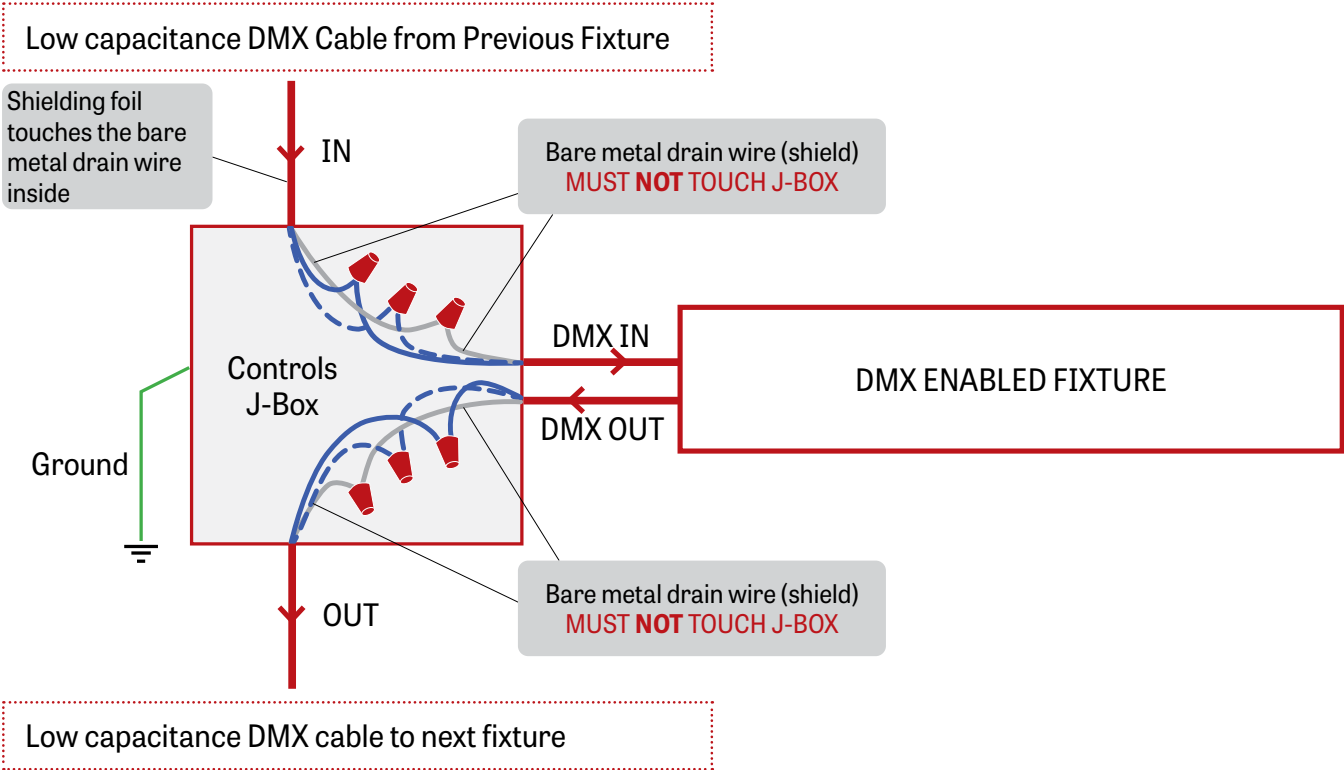

3 DMX CONNECTION RECESSED & SURFACE

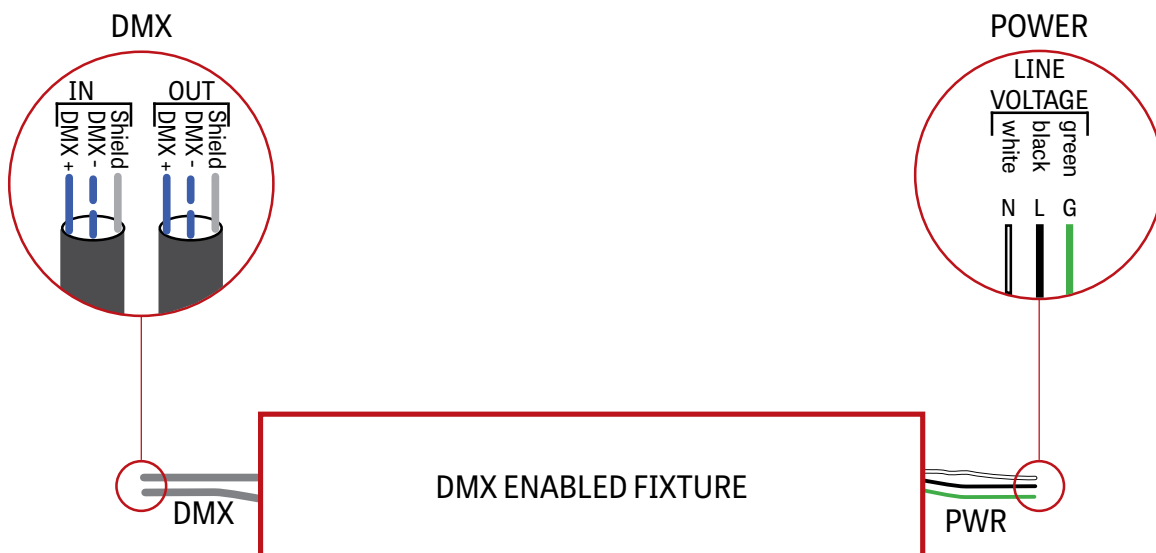

VIA 4 SEAL

SURFACE PATTERN

DIRECT

CHROMAWERX - SOLA, DUO

VIA WEATHER SERIES



4 DMX LAST FIXTURE DETAIL

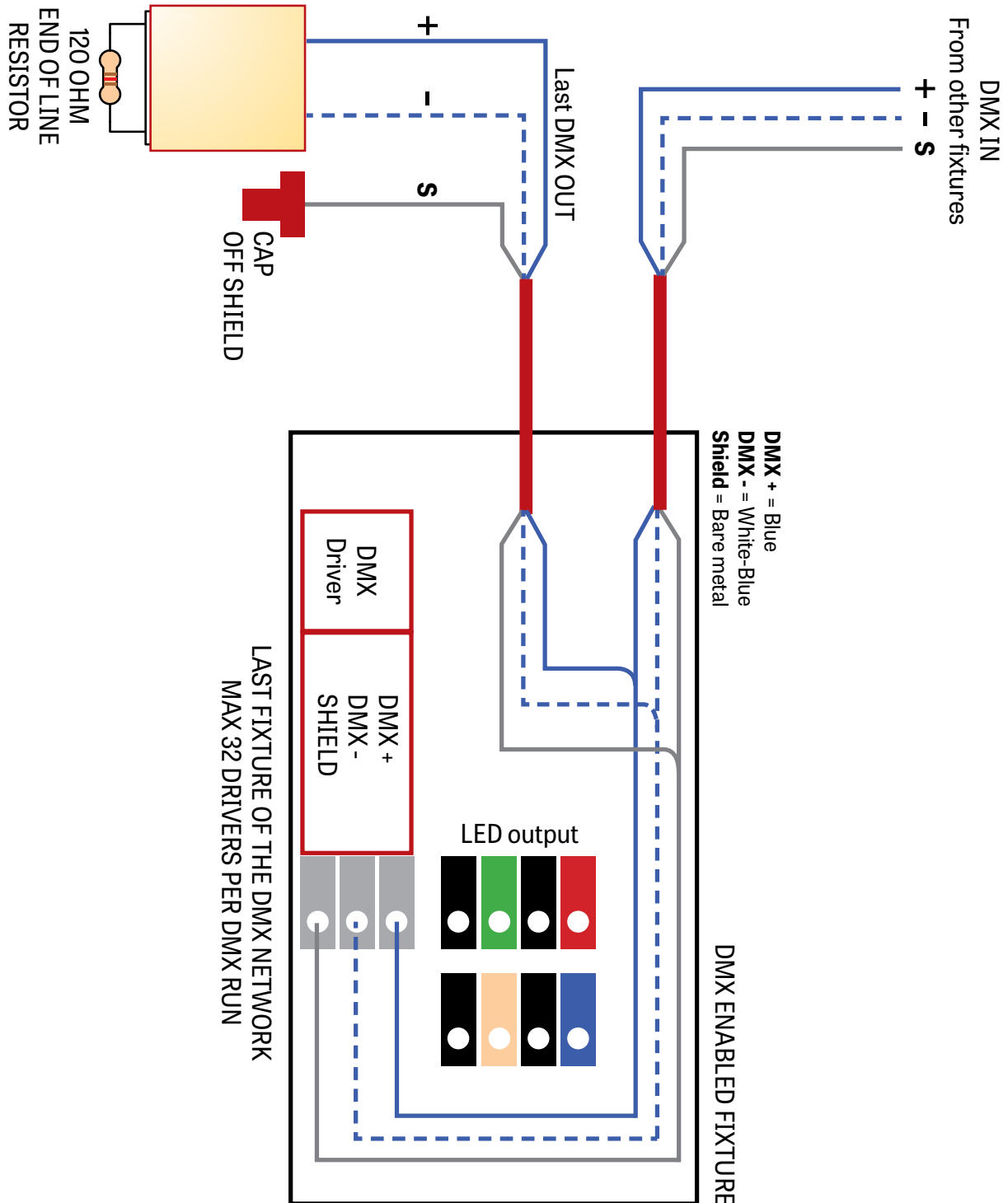

VIA 4 SEAL

SURFACE PATTERN

DIRECT

CHROMAWERX - SOLA, DUO

VIA WEATHER SERIES



DMX WALL CONTROLLER

DUO 1-4 ZONE

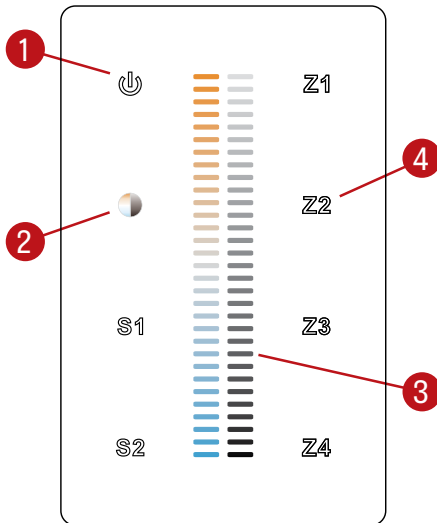

- (1) Power: Use this button to turn ON or OFF the fixture.
- (2) Brightness/CCT: Use the color/brightness toggle button to choose between color/brightness. When Blue: brightness is selected, when Yellow: color is selected.
- (3) Slider: Depending on the mode chosen in step 2, the slider will allow the user to set desired color or brightness.
- (4) Zone select: Up to 4 zones can be selected either independently or together. Once selected, the commands will be sent to the zone identified by a Blue LED.

Default DMX Addresses:

1 Warm

2 Cool

VIA 4 SEAL

SURFACE PATTERN

DIRECT

CHROMAWERX - SOLA, DUO

VIA WEATHER SERIES



DUAL 0-10V WALL CONTROLLER

Front Panel

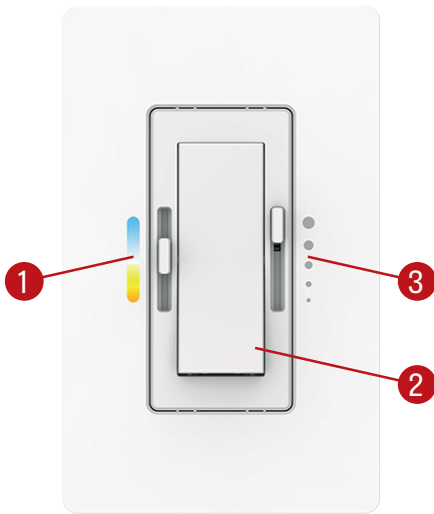

Controller image may differ

Dimensions

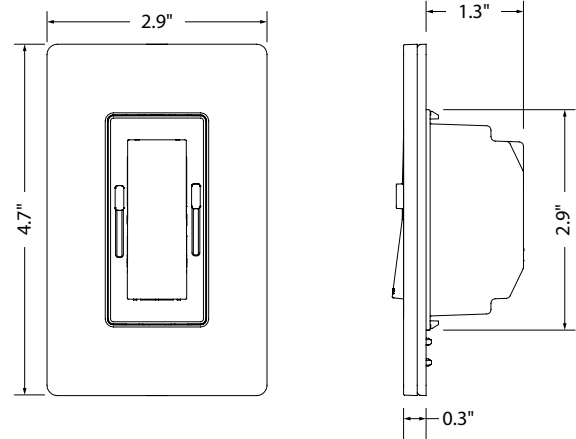

- (1) CCT control: Use this button to adjust the color temperature.
- (2) On/Off switch: Use this button to turn ON or OFF the fixture.
- (3) Dimming control: Use this button to adjust the brightness.

Wiring Diagram

