

Voilà

True 2" Cylinder Surface

LUMENWERX

Project: _____

Type: _____



Aperture Size

2"



Baffle Position

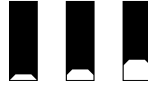

Flush, 1/2" & 1" regress baffles

Height

4.5", 6", 9"

Mounting Types

Surface

Cylinder & Cuboid Finishes

Textured matte white

Textured matte black

Custom RAL

Color Temperatures

2700K

3000K

3500K

4000K

SOLA

DUO

Delivered 529-1338 lm
7-14 Watts, up to 128 lm/W

Remote Drivers

0-10V, TRIAC & ELV

eldoLED

Lutron

DMX

Remote emergency battery pack

Voilà 2" Cylinders feature innovative Hyflex™ optics for precise beam control. Voilà 2" Cylinders are offered in round form factor, in three height options, all with remote drivers. The Voilà COB source matches other Lumenwerx luminaires, with 90 CRI and 2-step color consistency, and is available in Chromawerx SOLA and DUO. Complete Voilà offering includes 2" and 4" apertures; downlights, adjustables, and wall washers; round and square trim; and cylinders.

Performance

| LUMEN OUTPUT ¹ | WATTS | EFFICACY LM/W |
|---------------------------|-------|---------------|
| 896 lm | 7 W | 128 lm/W |
| 1103 lm | 10 W | 110 lm/W |
| 1338 lm | 14 W | 96 lm/W |

¹ Lumens packages are assuming 3500K, 80 CRI, 30° beam, round white baffle

Delivered Lumens for Round White Flush (IP) Baffles at 35K

| BEAM | 90 CRI | | | | | | | |
|----------------|--------|-----|------|------|------|------|------|-----|
| | 10 | 20 | 30 | 40 | 50 | 60 | 75 | 90 |
| Low - 7 W | 496 | 487 | 822 | 795 | 785 | 730 | 684 | 656 |
| Medium - 9.8 W | 641 | 630 | 1012 | 978 | 966 | 898 | 841 | 807 |
| High - 13.8 W | 828 | 814 | 1228 | 1187 | 1173 | 1090 | 1021 | 980 |

Cylinder

Product Specification

| LUMINAIRE ID | CYLINDER | BAFFLE | | LENS | |
|---|---|--|--|--|---|
| VO2CYS | | | | | |
| VO2CYS - Voilà 2" Cylinder Surface | HEIGHT 4.5 - 4.5" 6 - 6" 9 - 9" | FINISH TMW - Textured matte white TMB - Textured matte black CF# - Custom finish, specify RAL# (e.g. CF102B) | POSITION 1P - Flush 2P ¹² - ½" 3P ¹³ - 1" ¹ Only available with 50° beam or lower. ² Not available with 4.5" length. ³ Not available with 4.5" and 6" lengths. | FINISH TMW - Textured matte white TMB - Textured matte black CF# - Custom finish, specify RAL# (e.g. CF102B) | SDL - Soft diffused lens FDL - Frosted diffused lens NOL - No lens |

Light Element

| LIGHT SOURCE | BEAM | COLOR QUALITY | CRI | COLOR TEMP | OPTION |
|---|--|--|--|---|---|
| SW - Static white | 10 - 10° Narrow spot 20 - 20° Spot 30 - 30° Narrow flood 40 - 40° Flood 50 - 50° Wide flood 60 - 60° Very wide flood 75 - 75° Very wide flood 90 - 90° Open flood | 3 - 3 Step MacAdam Ellipse (For beam 10°&20°) 2 - 2 Step MacAdam Ellipse (For beam 30°-90°) | 80 - 80 CRI 90 - 90 CRI 97 ⁶ - 97 CRI ⁶ Not available with 3500K. | 27 - 2700K 30 - 3000K 35 - 3500K 40 - 4000K | HEX ⁷ - Hex louver NA - None ⁷ Not available with 60°/75°/90° beam options. |
| SOLA - Dim-to-warm DUO - Tunable white | 20 ⁴ - 20° Spot 40 ⁵ - 40° Flood 50 ⁵ - 50° Wide flood 60 ⁵ - 60° Very wide flood 75 ⁵ - 75° Very wide flood 90 ⁵ - 90° Open flood ⁴ Available with low output only. ⁵ Available with high output only. | 3 - 3 Step MacAdam Ellipse | 90 - 90 CRI (SOLA and DUO) | SOLA - Dim-to-warm 35K-22K DUO - Tunable white 27K-65K | |

Power Supply & Dimming

| VOLTAGE | WATTAGE (80 CRI) ⁹ | DIMMING |
|--|---|---|
| 120 - 120V UNV - 120V-277V 347 - 347V ⁸ Available with remote 0-10V dimming options RD1 and RSD1 only. Consult factory for details. | 7W - Low output 529-896 lm 10W - Medium output 683-1103 lm 14W - High output 883-1338 lm ⁹ For delivered lumens, see multiplier tables on page 3. SOLA 8W - Low output 560 lm (20° only) 13W - High output 740-900 lm (40° and up) DUO 5W - Low output 300 lm (20° only) 10W - High output 530-640 lm (40° and up) | REMOTE RD1 - 1% 0-10V RELV ¹⁰ - ELV 120V RTRI ¹⁰ - TRIAC 120V RLDE1 ¹¹ - Lutron Hi-lume 1% Eco RDA ¹¹ - DALI RELD0 - eldoLED 0.1% RELD1 - eldoLED 1% ¹⁰ Available with 120V only. ¹¹ On-site commissioning is required. SOLA RSD1 - Single 0-10V input DUO RDMX ¹¹ - DMX, to specify, see pages 6 to 8 RDDA ¹¹ - DALI RDD1 - Dual 0-10V input for CCT/intensity RLD2 ¹¹ - Lutron DALI-2 digital +EB ¹² - Emergency battery ¹² The code will be like the following example: RD1 + EB . |

Mounting

| MOUNTING TYPE | JBOX PLATE COVER/CONDUIT |
|---|--|
| DM - Direct mount JB - Junction box, round cover plate CD - Conduit feed, round canopy | FINISH TMW - Textured matte white TMB - Textured matte black CF# - Custom finish, specify RAL# (e.g. CF102B) NA ¹³ - None ¹³ Specify with direct (DM) mounting type option only. |

Photometrics

Please follow the multiplier tables to ensure correct lumen value. Beams, baffle color, lensing, CCT, CRI, baffle shape, baffle depth and accessories will change the lumen value.

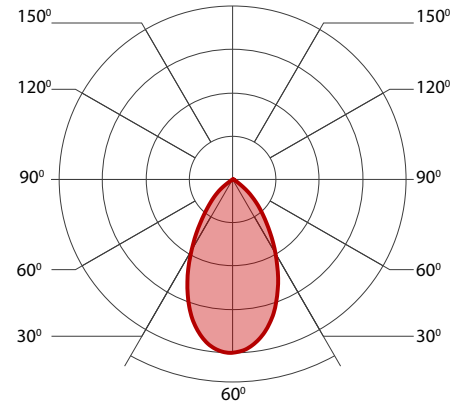
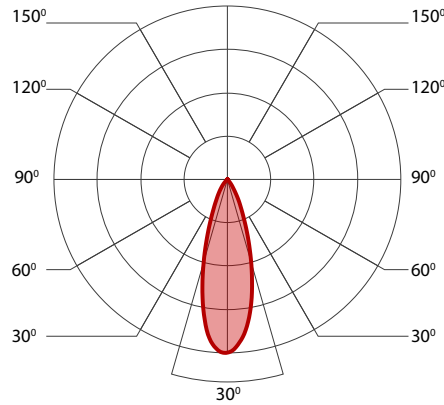
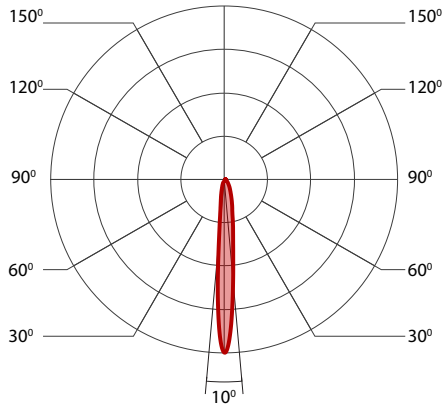

Delivered Lumens for Round White Flush (1P) Baffles - At 35K

| CRI | 80 CRI | | | | | | | | 90 CRI | | | | | | | |
|----------------|--------|-----|------|------|------|------|------|------|--------|-----|------|------|------|------|------|-----|
| | 10 | 20 | 30 | 40 | 50 | 60 | 75 | 90 | 10 | 20 | 30 | 40 | 50 | 60 | 75 | 90 |
| Low - 7 W | 537 | 529 | 896 | 869 | 859 | 795 | 748 | 711 | 496 | 487 | 822 | 795 | 785 | 730 | 684 | 656 |
| Medium - 9.8 W | 694 | 683 | 1103 | 1068 | 1057 | 978 | 921 | 876 | 641 | 630 | 1012 | 978 | 966 | 898 | 841 | 807 |
| High - 13.8 W | 897 | 883 | 1338 | 1297 | 1283 | 1187 | 1118 | 1062 | 828 | 814 | 1228 | 1187 | 1173 | 1090 | 1021 | 980 |

Delivered Lumens - At 30K

| 97 CRI | | | | | | | |
|--------|----|------|------|------|-----|-----|-----|
| 10 | 20 | 30 | 40 | 50 | 60 | 75 | 90 |
| NA | NA | 607 | 588 | 675 | 628 | 589 | 564 |
| NA | NA | 870 | 841 | 830 | 771 | 724 | 695 |
| NA | NA | 1056 | 1021 | 1009 | 937 | 878 | 855 |

Efficacy Based on Delivered Lumens - High 13.8 W

| BEAM | LPW | | | | | | | | |
|--------|-----|----|----|----|----|----|----|----|----|
| | 10 | 20 | 30 | 40 | 50 | 60 | 75 | 90 | |
| 80 CRI | | 65 | 64 | 97 | 94 | 93 | 86 | 81 | 77 |
| 90 CRI | | 60 | 59 | 89 | 86 | 85 | 79 | 74 | 71 |
| 97 CRI | | NA | NA | 77 | 74 | 73 | 68 | 64 | 61 |

Beam Angle

| BAFFLE POSITION | ACTUAL BEAM ANGLE | | | | | | | |
|----------------------------|-------------------|------|------|------|------|------|------|------|
| | 10 | 20 | 30 | 40 | 50 | 60 | 75 | 90 |
| 2" Cylinder Flush | 10.4 | 19.1 | 32.0 | 40.0 | 46.5 | 59.0 | 73.1 | 80.1 |
| 2" Cylinder Regressed 1/2" | 10.4 | 19.1 | 31.6 | 38.7 | 45.0 | 55.3 | 69.9 | 75.1 |
| 2" Cylinder Regressed 1" | 10.4 | 19.0 | 30.2 | 36.6 | 42.0 | 50.9 | 62.8 | 67.7 |

Multiplier - Efficacy

| BAFFLE POSITION | 10 | 20 | 30 | 40 | 50 | 60 | 75 | 90 |
|----------------------------|------|------|------|------|------|------|------|------|
| 2" Cylinder Flush | 1 | 1 | 1 | 1 | 1 | 1 | 1 | 1 |
| 2" Cylinder Regressed 1/2" | 0.97 | 0.97 | 0.98 | 0.97 | 0.96 | 0.96 | 0.94 | 0.94 |
| 2" Cylinder Regressed 1" | 0.93 | 0.93 | 0.94 | 0.92 | 0.91 | 0.89 | 0.87 | 0.85 |

SOLA and DUO Max Wattage

| BEAM | 90 CRI | | | | | | | |
|------|--------|----|----|----|----|----|----|----|
| | 10 | 20 | 30 | 40 | 50 | 60 | 75 | 90 |
| DUO | NA | 5 | NA | 10 | 10 | 10 | 10 | 10 |
| SOLA | NA | 8 | NA | 13 | 13 | 13 | 13 | 13 |

Multiplier - CCT

| CCT | |
|-------|------|
| 2700K | 0.9 |
| 3000K | 0.95 |
| 3500K | 1 |
| 4000K | 1.05 |

Multiplier - Baffle Color

| BAFFLE VARIABLES | | |
|------------------|-------|------|
| White | Round | 1 |
| Black | Round | 0.95 |

Multiplier - Optical Options

| LENS AND LOUVERS | |
|--------------------|------|
| No lens | 1 |
| Soft diffused lens | 0.94 |
| Frosted lens | 0.78 |
| Hex louver | 0.82 |

For SOLA and DUO, please consult factory.

Project: _____

Type: _____

Technical Specification

DESCRIPTION Ø 2" cylinder with multiple height, output, color, and dimming options in a variety of standard or custom finishes.

CYLINDER

Die-cast and extruded aluminum.

Mounting Type: Direct mount, junction box and conduit

Canopy: Junction box cover plate for junction box mounting type, conduit (when recessed wiring is not possible)

Finish: Powder coated paint, textured white & black matte. Custom colors also available (provide RAL #)

FIELD REPLACEABLE LIGHT ELEMENT

LED Module: Integral COB module. 90 CRI and 2 SDCM, Standard with options of 80 CRI, or 97 CRI. L80 > 60,000 hours

Light Output: From 529-1338 lumens

HyFlex™ Optics: Proprietary TIR/reflector with field interchangeable beam smoothing lenses

Thermal Management: Cold-forged aluminum heat sink to maximize thermal dissipation.

BAFFLE

Die-cast aluminum.

Baffle position: Flush, ½" and 1" regress

CHROMAWERX SOLA (dim-to-warm) and DUO (tunable white). See pages 5 for more information.

ELECTRICAL

Remote drivers: 0-10V, ELV, TRIAC

Lutron Hi-Lume EcoSystem, DALI, eldoLED 0.1%, eldoLED 1%, DMX, Lutron DALI-2 digital.

Emergency Options: Bodine emergency battery back-up is installed remotely. For 7W or 10W fixtures, battery provides 6W of power. For 14W fixtures, battery provides 10W of power.

ENVIRONMENT Ambient temperature at fixture location shall be within 0°C/32°F - 25°C/77°F, indoor dry or damp as well as outdoor damp use (canopies or marquees).

LISTING cETLus listed to UL 1598 and CAN/CSA Standard C22.2 No. 250.0

WARRANTY 5 year limited warranty on LED module and power supply. Guaranteed to maintain 70% lumen maintenance.

Light

Cylinder Housing

4.5", 6", 9" Height
Textured Matte White Finish
Textured Matte Black Finish
Custom Finish Specify RAL#

Light Element

Heat Sink
LED Module
Hyflex™ Optics
8 Available Beam Options
10° - 90°

Lens

Frosted
Soft Diffused

Baffle

3 Baffle Positions - Flush, ½", and 1"
Textured Matte White Finish
Textured Matte Black Finish
Custom Finish Specify RAL#

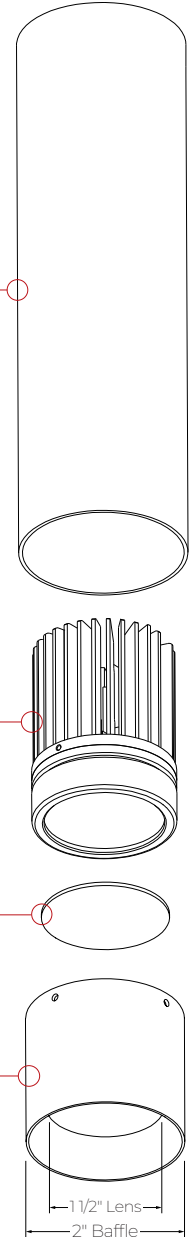

Mounting

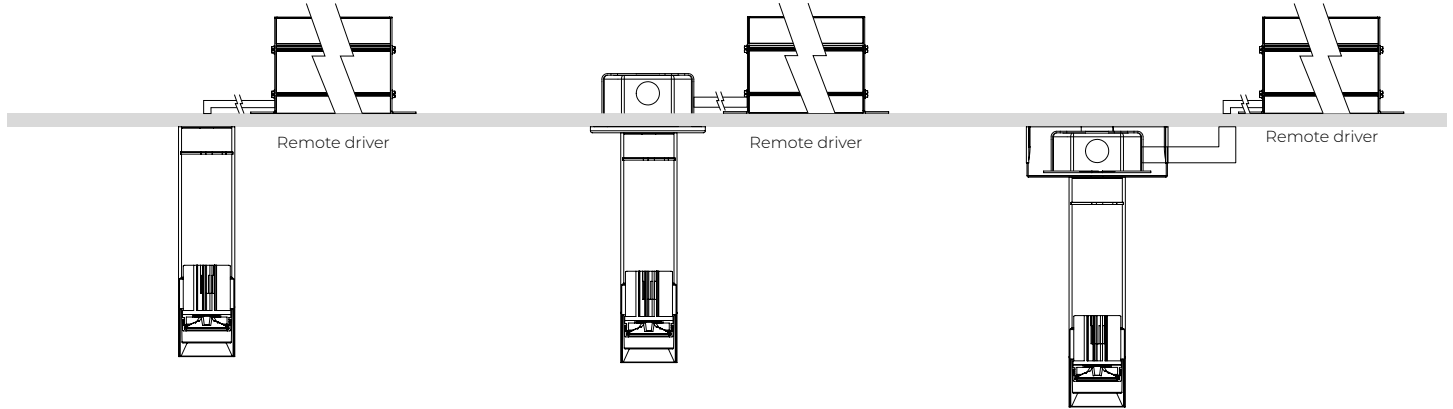

DM - Direct Mount
Remote driver

JB - Junction Box Cover Plate
Remote driver
Round canopy Ø 4 ½"
Height 0.275"

CD - Conduit Feed Canopy
Remote driver
For surface mounted J-box
Round canopy Ø 5 ½"
Height 2"

Optics

Hyflex™ optics provide precise optical control in a remarkably compact form.

The core of this four-tier system is compound reflector with a central TIR element, just 1.06" deep.

Beam-smoothing discs perfect beam angles up to 90°. Beam angles are easily interchanged in the field.

Light Source - LED

Compact COB (Chip-On-Board) LED module, available in 2700K, 3000K, 3500K and 4000K with a choice of 80 CRI or 90 CRI with elevated R9 value (for 97 CRI, consult factory). Color consistency is maintained to within 2 SDCM. All LEDs have been tested in accordance with IESNA LM-80-08 and the results have shown L80 lumen maintenance greater than 60,000 hours. Absolute product photometry is measured and presented in accordance with IESNA LM-79, unless otherwise indicated.

Beam Angles

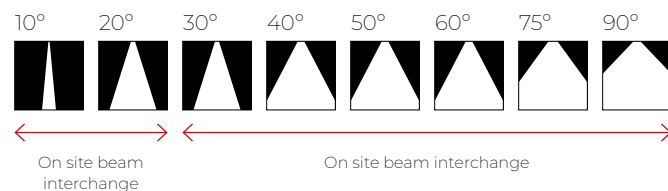

Chromawerx Sola is single-channel control that dims output while warming the color temperature in a pre-determined relationship. A simple analog control adjusts a specially populated LED array to emulate the effect of dimming a filament source.



Chromawerx Duo offers a two-channel control system which uses analog or digital protocols for synchronous control of both warm (2700K) to cool (6500K) LED arrays - maintaining a CRI above 90. The range of color DUO offers is useful for entraining circadian rhythms, stimulating alertness, and compensating for jet lag among other applications. The Chromawerx drivers are programmed to limit maximum light output and power usage across all color temperatures.

DUO GENERIC DMX NETWORK ARCHITECTURE

A qualified DMX integrator is required to assure proper installation and commissioning of the DMX network. **When placing the PO, please provide the contact information of your DMX integrator.**

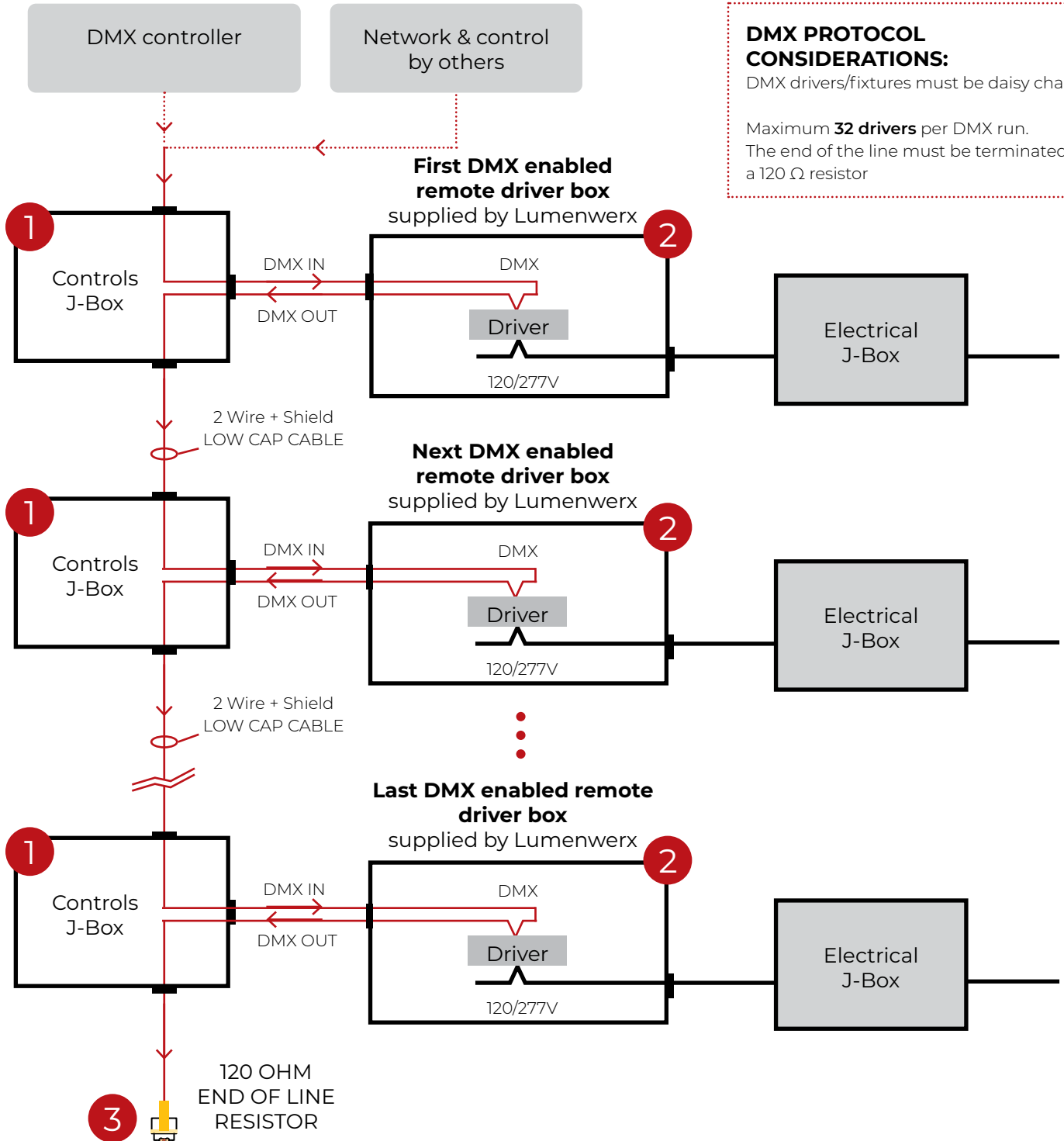

DMX PROTOCOL CONSIDERATIONS:
 DMX drivers/fixtures must be daisy chained.

 Maximum **32 drivers** per DMX run.
 The end of the line must be terminated by a 120 Ω resistor

1 J-BOX DMX DAISY CHAIN DETAIL

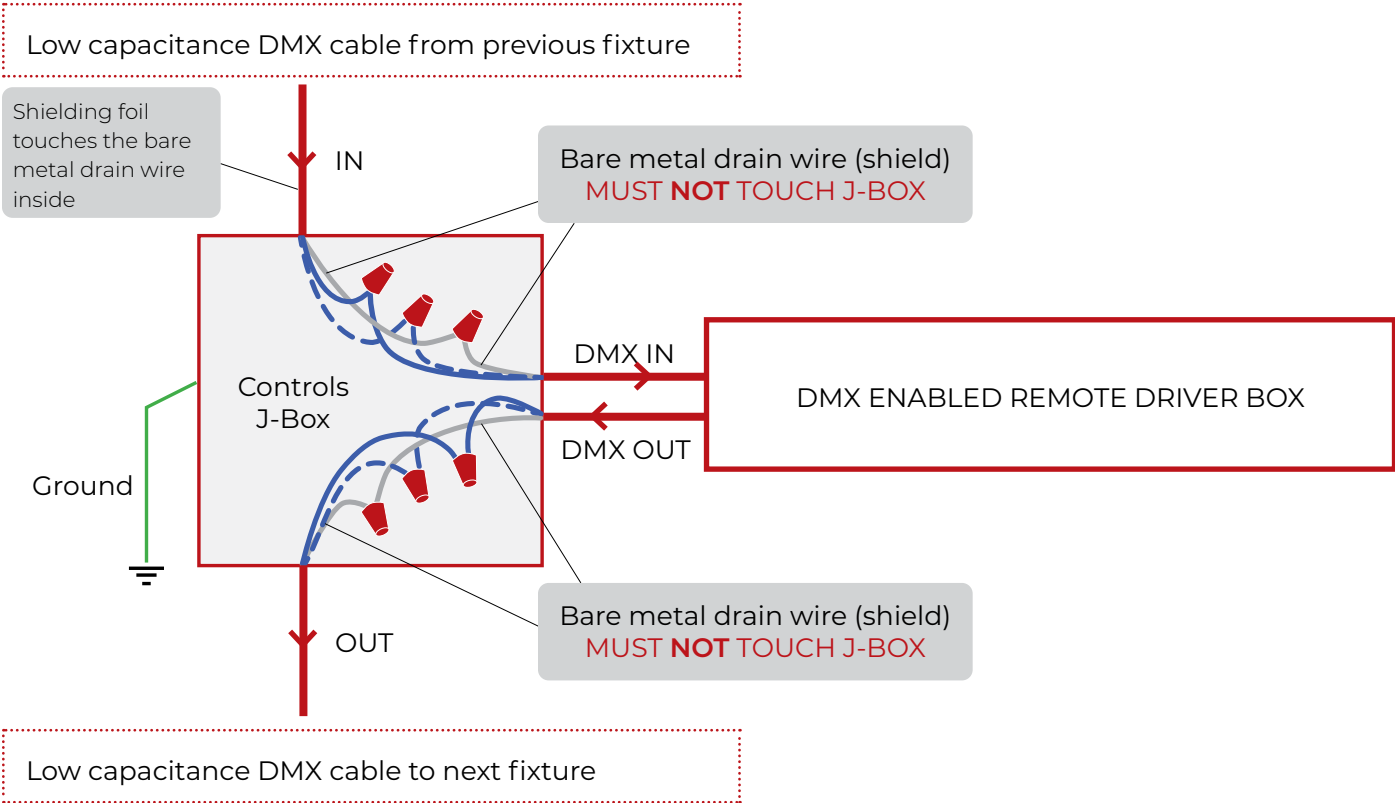

2 DMX CONNECTION REMOTE DRIVER

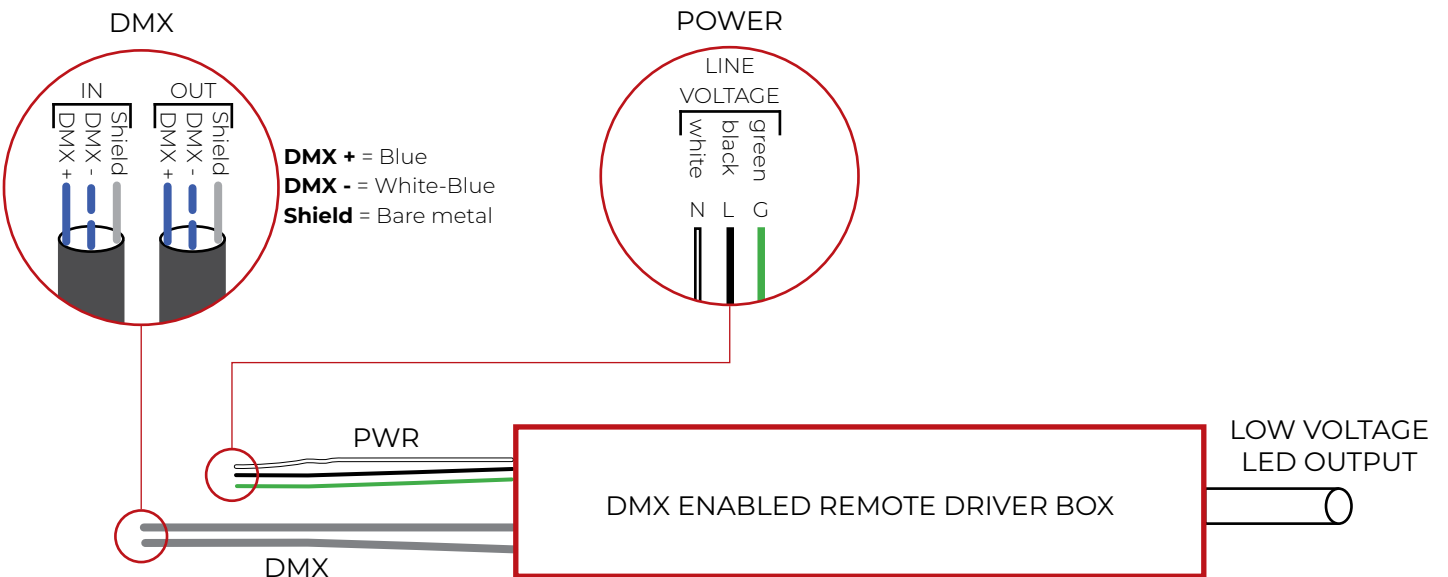

3 LAST DMX CONNECTION DETAIL

